

885

0330.

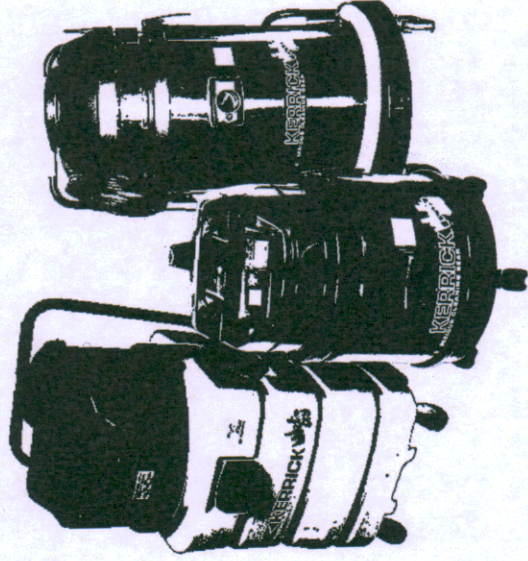

OPERATING & MAINTENANCE MANUAL



COMMERCIAL WET & DRY VACUUM CLEANERS

303PL, 423PL, 440PL, 503PL, 623PL, 640PL, ASTERDAM 115HP,
AMSTERDAM 315HP, AMSTERDAM 429M, KOALA, MEC 215, MEC 623,
PUMP OUT, ROKY 115, ROKY 315, ROKY 423R, VEGAS 215, VEGAS 515,
VEGAS 429, YES PLAY 215, YES PLAY 429, YES PLAY 515

**Read Safety & Operating Instructions
Before Commencing Operation**

**THESE INSTRUCTIONS MUST BE READ AND ADHERED TO
BEFORE OPERATING THIS MACHINE.**

INTRODUCTION

Your new Kerrick Wet & Dry pick up vacuum cleaner comes complete with a full range of accessories designed to make your cleaning task and easy one. Manufactured in Italy this is a high quality unit that if treated properly will give many years of service.

To get the best from your Kerrick machine we suggest you follow the operating and maintenance details contained in this document.

SAFETY MANAGEMENT PROCEDURES

These instructions must be read and adhered to before operating this machine. Failure to do so may result in injury to the operator, nearby persons, or damage to property, or this machine.

- The packaging around the cleaner (plastic bags, clips, ties etc) pose a choking hazard and should be kept out of the reach of children and animals.
- This machine is not designed to be used by children or mentally disabled individuals and if used incorrectly can be harmful.
- The end of the suction hose / accessories must be kept away from your face and the faces of others at all times during operation as the suction created can cause damage to the eyes, ears a mouth in particular.
- Do not use adapters or multiple sockets, without knowing the electrical input of each user.
- If any electrical extension is used, check that it corresponds to the absorbed power of the machine and that the connection of the plug with the socket is compliant and sealed.
- Take care of the electrical cable. It must be protected from water, tears and chemical agents. Do not repair the cable in case of tears, but replace it with a new one. The cable must be replaced by the manufacturer or its service agent or a similarly qualified person in order to avoid further hazard.
- **DO NOT** pull cable to drag the machine into position or to remove the plug from socket.
- Pull the plug out only when the machine is switched off.
- **DO NOT** handle the plug with wet hands.
- Unplug the cable before servicing machine.
- Never use flammable liquids or operate machine in or near flammable liquids, vapors or combustible dusts.
- Should the machine leak liquid or foam, make strange noise or get abnormally hot switch off the machine immediately and take it in for a service.

- Do not vacuum materials that could damage filters such as glass or metal shavings
- This vacuum cleaner should **NEVER** be immersed in water.
- **DO NOT** use solvent or strong detergents to clean this machine.
- Store the machine, well cleaned, in a cool and dry place.

WARNINGS:

- All the electrical repairs must be performed by qualified personal only!
- Kerrick cannot be held responsible for any damage/injury caused to persons or property, because of the incorrect use of the machine due to procedures being used which are not specified in this instruction manual.

UNPACKING AND SETTING UP

Read safety and operating instructions before commencing operation. Assembly details and information on how to carryout various cleaning operations are outlined below:

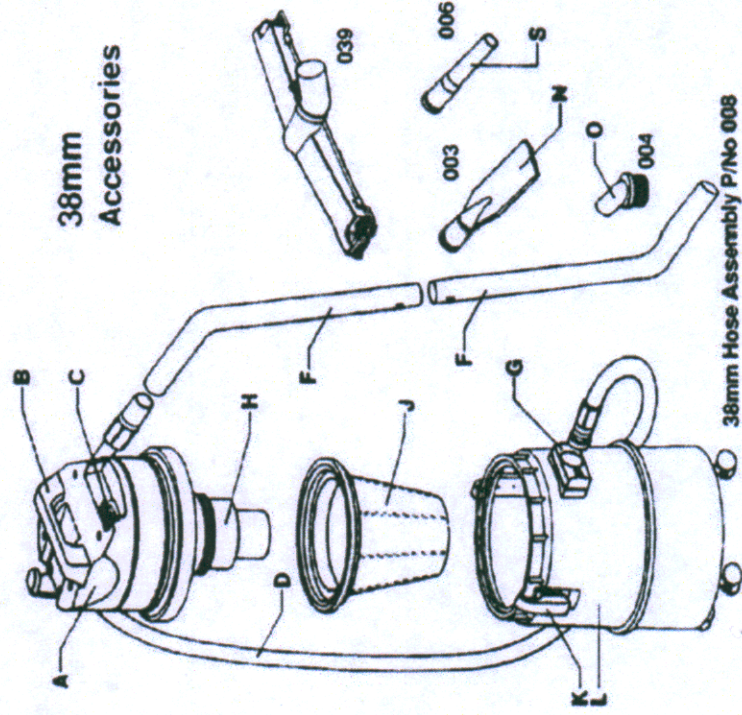

Schematic – General Tank & Tool Configuration

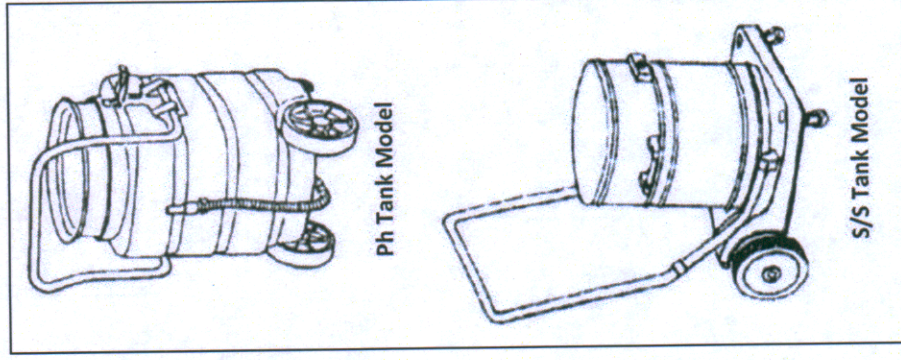

36mm Accessories

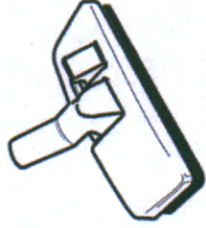
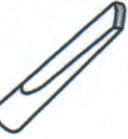
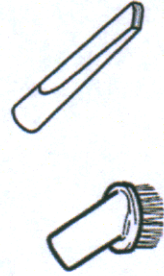

Wet Pick-Up Models Only

- 1) Lift the machine out of the box by gently angling the box and pulling the vacuum cleaner by its carry handle (B), or with 400/600 series machines lay the box on its end and wheel the machine from the carton.
- 2) Insert the flexible hose (D) into the tank inlet (G) and press until you hear a click as it locks into place. Unclip the two clips (K) on the side of the motor head (A) and lift the motor from the tank (L).
- 3) **If Dry Vacuuming:** Ensure that cloth filter (J) and its bag support ring are fitted into the top of the tank (L), replace the motor head (A) back onto the tank and clip into place.
Note: Failure to use the fabric filter during dry operation will result in motor failure due to clogging and overheating the motor thereby nullifying the motor warranty.
If Wet Vacuuming: Ensure that cloth filter and its support ring (J) have been removed and replace the motor head (A) back onto the tank and clip into place.
- 4) Screw the top extension wand (F) into the suction hose (D), ensure the suction regulation hole is facing up.
- 5) Fit the two piece extension wands (F&F) together. The top extension tube has a black suction regulating control knob. This knob allows the operator to vary the suction when vacuuming such things as curtains, upholstery, mats, carpet, tiles. Turn knob fully to right (clockwise) for maximum suction, to decrease suction turn knob left (anticlockwise).
- 6) Select one of the following tools Dry Floor Tool, Wet Floor Tool, Round Brush, Confined Space Tool or Crevice Tool and fit it to the lower end of wand (F).
- 7) Your Kerrick vacuum cleaner is designed to operate on **New Zealand: 240volt 50Hz** or **Australia: 230volt 50Hz**, single phase power. Check the voltage of the machine matches the voltage output of your power point then plug the machine in. Your machine is now ready to use.

On 2 and 3 motor models, the suction power can be adjusted by turning 1, 2 or 3 motors on together or independently. It is important that machine tanks be emptied regularly, preferably after each use.

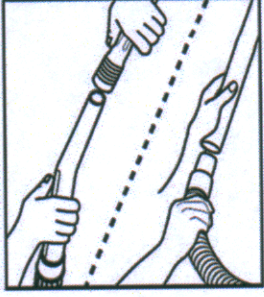
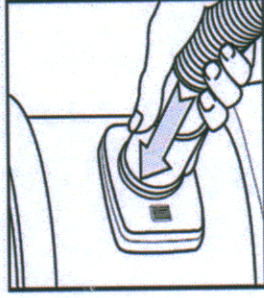
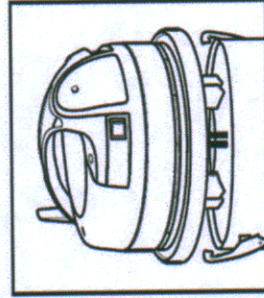
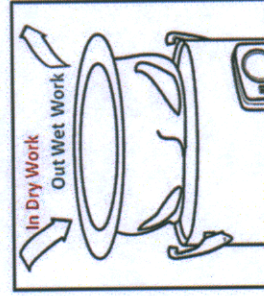

8) 38mm Wet/Dry models come complete with a multi-purpose floor tool suitable for vacuuming hard floors and carpets in both wet and dry applications.

The tool (part number VP 00039) can be adjusted to various cleaning jobs. The height adjustment is made by turning the thumb screw (1) until the wheels (2) hold the suction head at the required height. To change the inserts, loosen the thumb screw (1) so the wheel axle (2) can be swung up, (3) turn up the insert and stop at the vertical position. The insert rails can now be changed (4).

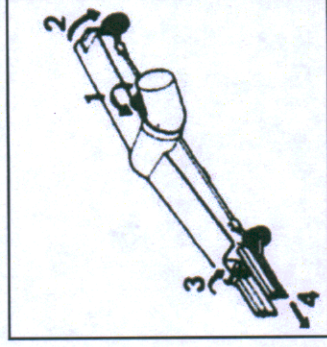

9) **Wet Vacuum Cleaning:** Mount the rubber rails (X) with the grooved sides facing outwards.

Dry Vacuuming Carpet: Mount plastic side rail (Y) in the front and brush rail (Z) at the back.

Dry Vacuuming Hard Floor: For dry vacuuming smooth surfaces eg tile, concrete, linoleum mount both the front and back with brush rails (Z).

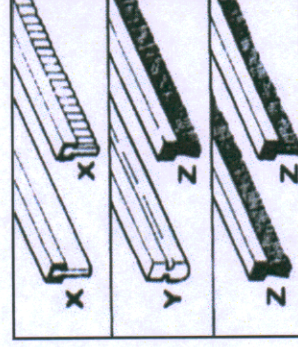

WARNING:

- Failure to use the fabric filter during dry operation will result in motor failure due to clogging and overheating of the motor thereby nullifying the motor warranty.

Emptying Your Tank After Dry Vacuuming

Turn off and unplug your vacuum cleaner from the mains power. A build up of dust and debris in the filter bag will result in the filter becoming clogged, which in turn places excessive load on the motor and may lead to it burning out. It's therefore extremely important to empty and clean the filter bag after every use to ensure maximum operating efficiency. From time to time you should also either wash your filter bag or clean it with an air compressor.

- 1) Debris can be emptied by removing the motor head (A) and cloth filter bag (J), gently shake the filter bag before removing from the tank (L). If using the system as bagless then carry tank (L) to a disposal area and tip the contents of the tank into the rubbish. Also shake the dust from the filter bag into the rubbish.
- 2) The filter bag can be removed from the filter ring and washed by hand or washing machine. Ensure the filter is thoroughly dry before refitting to the machine. Alternatively the bag can be blasted clean using compressed air. Fabric filter bags should be replaced at least every 12 months.
- 3) It is recommended that disposable filter bags be used when vacuuming fine dust. The use of such bags improves the performance of the vacuum cleaner, protects the motor and protects operators from excess dust inhalation when emptying the tank.

- 4) To fit a paper bag filter simply push the cardboard bag support firmly over the internal tank inlet so that it sits snugly in place.
- 5) To ensure you use the right disposable bag for your vacuum model talk to the team at Kerrick, they will provide you with all the part numbers and information you need.

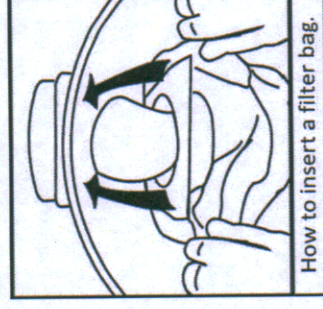

Emptying Your Tank After Wet Vacuuming

- 1) Turn off and unplug your vacuum cleaner from the mains power and wheel vacuum cleaner to an appropriate disposal area. Detach head clamps (K), remove head (A) and gently tip fluid from tank.
On certain PHD tank models, tank emptying can be done quickly by opening a tank drain hose.
- 2) Dry the tank thoroughly prior to re-assembly of the machine.

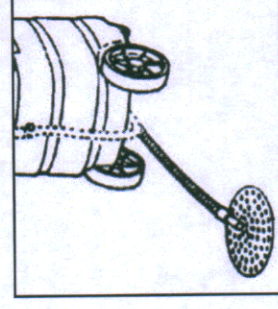

Cleaning the Float

The underside of the motor head is fitted with a float (H) which when wet vacuuming, prevents the container overflowing. The float also prevents the liquid from penetrating into the motor of the machine should the vacuum cleaner tip over. In order to keep the machine in good operational condition the float (H) must be cleaned at regular intervals. After wet vacuuming the tank, motor heads, and accessories should be cleaned and wiped dry.

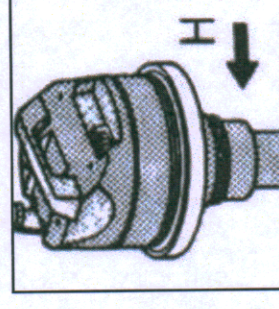

MAINTENANCE

If foam or liquid comes from the machine exhaust (lower part of the motor housing) switch off immediately by isolating at the mains.

- i) Check float level device for cleanliness and correct operation.
- ii) Empty machine after isolating at mains socket then refill container with 1litre of de-foamer, increase volume of de-foamer if necessary.
- iii) Dry machine body with a cloth before re-using.
- iv) Should the machine still leak, make strange noises or become abnormally hot stop all use and take it into an approved service agent for repair.

Maintenance of electrical components should only be carried out by a certified electrician otherwise return the machine to your nearest Kerrick Branch or Kerrick Service Agent for repair. Never carry out any repairs without first disconnecting machines from the mains supply.

On a Daily Basis Check:

- i) Check for correct operation of high water level cut-off float device. Ensure float is free to operate and that the seat on the underside of the motor housing is in good condition. Ensure the float gauze cage is clean and wash out tank with clean water after use. This prevents the buildup of bacteria and unpleasant odours which can become a problem if your machine is left uncleaned for long periods of time.
- ii) Check machine switch(s) for damage, ensure plastic switch cover is soundly in place, check that the filter bag is not clogged, replace filter bag every 12 months or when necessary in high use applications.

On a Weekly Basis Check:

- i) Check hoses, extension tubes, accessories for damage of blockage (unseen blockages sometimes occur so check thoroughly).
- ii) Examine filter bag (replace or clean).

At Regular Intervals Check:

- i) Check mains cable and plug for damage.
- ii) Check machine for damage.

Every 1000 Hours or 4 Monthly Check:

- i) Examine vacuum motors for carbon brush wear. Remove all traces of carbon with a fine dry brush. Ensure no traces of moisture are present.
- ii) Carry out full electrical safety check. Never use an air line for cleaning purposes unless fitted with a moisture filter.

TROUBLE SHOOTING

Wet & Dry Vacuum Cleaners		
Trouble	Possible Cause	Remedy
Insufficient vacuum	Filter clogged and blocking airflow (dry vacuuming only)	Clean filter and empty tank.
	Tank full with float blocking motor inlet (wet vacuuming only)	Empty tank
	Faulty motor	Return to Kerrick or Kerrick Service agent and have motor replaced.
	Hose or tooling are cracked and disrupting suction	Repair and replace as required
Vacuum overheats	Filter clogged and blocking airflow (dry vacuuming only)	Clean filter and empty tank.
	Faulty motor	Return to Kerrick or Kerrick Service agent and have motor replaced.
Float closes off	Waste water tank is full	Empty waste water tank

Servicing

Kerrick's workshop facilities are staffed by experienced technicians providing servicing, repair and manufacturing for a range of products including; vacuum cleaners, extractors, water blasters, pressure cleaners, pumps and more.

We work on everything from commercial and light industrial to large heavy duty equipment and offer customized design build services. We also warehouse and ship a comprehensive range of spare parts for your convenience.

For more information on your product, to book in a service or repair or to order spare parts give Kerrick a call or send through and enquiry on our website. Contact details can be seen below:

KERRICK NEW ZEALAND
0800 2 KERRICK (0800 253 774)
SALES@KERRICK.CO.NZ
WWW.KERRICK.CO.NZ

KERRICK AUSTRALIA
1300 KERRICK (1300 537 742)
SALES@KERRICK.COM.AU
WWW.KERRICK.COM.AU