

Manual # 352

Machine Type # - 061000

Power Analyzer.

## Loading a new operation program for the Analyzer analyzer

### Points to consider:

- Cartridges are specific for each analyzer. Once the program is loaded, the cartridge will be only valid for this analyzer and the user will be able to load again the program anytime he requires.
- Whether a cartridge related with an analyzer is used for a different analyzer, the memory position where the program is attempted to be load over may be deleted.
- To perform the program loading process, check that the Analyzer battery is charged since this process cannot be carried out whether the supplier set is connected to the analyzer.

### To load any program, follow these instruction precisely:

- Turn the meter off.
- Connect the cartridge to the *AUX* input of the meter. (Once the cartridge is connected, **DON'T TURN IT** on any way)
- Turn the meter on.
- Select with the keys [**^**] & [**v**] that you want to perform a program loading action (LOAD PROGRAM).
- Press [**ENTER**] or wait for a while to confirm this operation.
- Select the position to save the program into.<sup>1</sup>
- The Analyzer will perform a test to check that the cartridge has been properly connected.
- If an inserted cartridge is detected, then the program will be loaded.
- Once the loading is completed, reset the meter.
- If no cartridge was found or a loading mistake occurred, reset the meter and redo the above steps.
- It's necessary to load the co-processor's cartridge on co-processor's position, otherwise the program won't work.

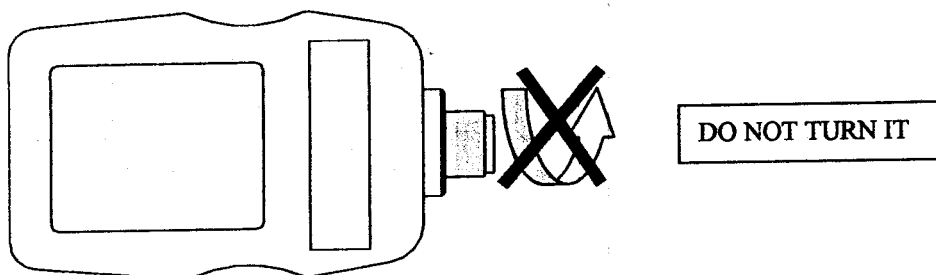

**A cartridge will be only valid for the analyzer which the program was for the first time loaded into.**  
**Note on the cartridge the serial number of its related Analyzer**

<sup>1</sup> For some versions there are gaps for new programs; then this question is not asked, and program is automatically saved in the first free position.



#81-806  
#81-807

800 Series Power Analyzer  
Model 806 Instruction Manual

Manual # 352

Machine Type - Power Analyzer Ideal  
807 clw clamp e adapta

Machine Type # 061000

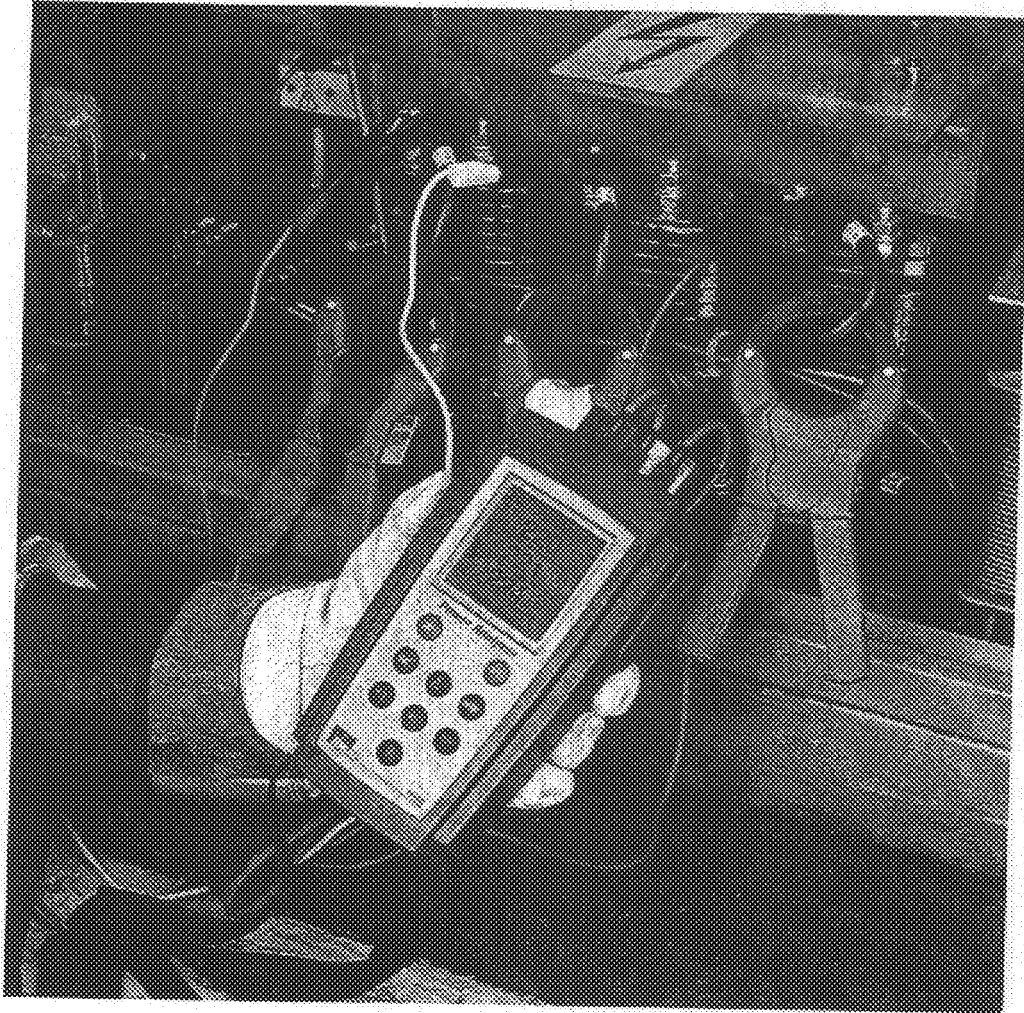

## Table of Contents

1. Basic instructions.....	3	5.2.4. Date/time settings.....	28
1.1. Introduction.....	3	5.2.5. Password settings.....	29
1.2. Safety.....	4	5.2.6. Recall factory settings.	29
2. Model 806 features.....	4	5.3. Display menu.....	30
2.1. Product features.....	4	5.3.1. Bar graph settings.....	30
2.1.1. Backlight.....	5	5.3.2. Exploded view settings.	31
2.1.2. Auto power off.....	5	5.3.3. Screen contrast.....	32
2.1.3. Auto-detect clamps.....	5	5.4. Run men.....	33
2.2. Display & keypad.....	5	5.5. Files menu.....	33
2.3. Voltage and current input		5.5.1. Directory.....	33
Terminals.....	6	5.5.2. Deleting a file.....	34
3. Startup.....	7	5.5.3. Formatting the memory.	35
3.1. Selecting a program.....	7	5.6. Clear menu.....	35
3.2. Loading a new program.....	7	5.6.1. Clearing energy	
3.3. Charging the battery.....	8	Counters.....	35
3.4. Turning the analyzer off.....	9	5.6.2. Clearing min/max	
4. Model 806 display screens.....	10	Values.....	36
4.1. Table view.....	10	5.7. Off menu.....	36
3-phase 4-wire.....	11	6. Hooking up the analyzer.....	36
4.1.1. 3-phase 3-wire.....	12	6.1.1. 3-phase 4-wire	
4.1.2. Single-phase.....	12	connection diagram.....	37
4.1.3. Split-phase.....	13	6.1.2. 3-phase 3-wire	
4.1.4. 2 wattmeter method		connection diagram.....	37
(3 PT, 2 CT).....	13	6.1.3. Single-phase	
4.2. Exploded view.....	14	connection diagram.....	38
4.3. Bar graph.....	15	6.1.4. Split-phase	
4.4. Scope view.....	16	connection diagram.....	38
4.4.1. Waveform zoom.....	17	6.1.5. 2 wattmeter method	
4.4.2. Harmonic bar graph.....	18	connection diagram....	39
4.5. Setup screen.....	19	7. Recording data.....	39
4.6. Recording messages.....	20	8. Downloading data to your PC.....	40
5. Programming the 806.....	20	9. PowerVision™ Software and	
5.1. Entering the programming		interactive demo.....	42
Menu.....	20	10. Technical specifications.....	42
5.2. Setup menu.....	22	11. Optional programs and	
5.2.1. Measurement settings.	22	Accessories.....	43
5.2.2. Recording settings.....	23	12. Quick reference guide.....	45
5.2.3. Communication		13. Warranty and repair.....	47
Settings.....	27		

## 1. Basic instructions

This manual is intended to familiarize the new owner of the Model 806 Power Analyzer with its features and operations.

IDEAL's 800 series power analyzers are built with components incorporating the most advanced technology in microelectronics, providing features and performance only found in the highest quality power meters and harmonic analyzers. They will provide you with years of accurate and dependable performance.

The model 806 is a valuable tool to reduce energy cost, and troubleshoot electrical equipment and distribution systems. The model 806 can be used on a variety of electrical systems, including: 3-phase 4-wire, 3-phase 3-wire, single-phase, split phase, and on power distribution using the two wattmeter method of power calculation (3PT, 2CT).

**WARNING - Read this manual completely before connecting and powering the analyzer to avoid damage that may result from improper use of this equipment**

### 1.1 Introduction

After receiving the analyzer, please check the following:

1. Check that the instrument has not been damaged in transit.
2. The power analyzer kit contains all items
  - Model 806 power analyzer
  - 1 Power supply/RS-232 interface
  - 1 Power cord
  - 1 cable for connecting the 806 to the power supply/RS-232 interface
  - 1 RS-232 communication cable.
  - 4 Voltage leads
  - 4 Alligator clips
  - 3 1000AAC current clamp adapters
  - 1 100AAC current clamp adapter (61-807 only)
  - 1 PowerVision™ instruction manual
  - 1 806 Power Analyzer instruction manual
  - CD with the PowerVision™ Analysis Software and Interactive Demo

## 1.2 Safety

### WARNING!

1. Read the instruction manual before using the 806 power analyzer. It contains important information necessary to guarantee proper operation of the instrument.
2. To avoid electrical shock hazards and/or damage to the meter:
  - Do not exceed the voltage ratings for the meter. Use caution when measuring voltage.
  - Do not use during electrical storms. Electrical storms may result in high voltage. High-energy transients can damage the meter and present a dangerous shock hazard.
3. Ensure meter is in proper working order before using. Visually inspect meter for damage.
4. Never ground yourself when taking electrical measurements. Do not touch exposed metal pipes, outlets, fixtures etc. Keep your body isolated from ground by using dry clothing, rubber shoes, mats, or any other approved insulating material. Keep your fingers behind the finger guards on the probes.
5. Work with others.
5. When disconnecting from a circuit, disconnect the hot lead first, then the common lead.
6. Disconnect the meter from the circuit before turning off any inductor, including motors, transformers, and solenoids.

If the maximum allowable phase-to-neutral voltage of 500 V has been exceeded during the measuring process, the analyzer will display a warning message **[WARNING MAX 500 V]** at the bottom of the display screen to let the user know that this rating has been exceeded. When measuring phase-to-phase voltages the limit is set at 866V.

## 2. Model 806 features

The IDEAL Power Analyzer is the most versatile and easy-to-use power quality test instrument on the market. Four programs measure and analyze power quality on both single- and three-phase electrical systems. Instantaneous readouts including tables, bar graphs and even individual waveforms make job site data interpretation easy. With a real-time clock and 1 MB of memory, the Power Analyzer stores data that can be downloaded to a personal computer for in-depth analysis using PowerVision™ software.

The Energy and Harmonics Program comes standard with the IDEAL Power Analyzer. Disturbances, Check-Meter, Fast-Check and Flicker Programs are available separately. These programs allow the user to monitor additional facets of power quality with a single test instrument. The details of each program are discussed in section 11 of this instruction manual.

## 1.2 Product features

### Features

- True RMS
- Single- or three-phase measurements
- Data logging (1 MB memory)
- 4-channels for voltage measurements
- 4-channels for current measurements
- Auto-detect clamps
- Auto ranging
- Min/max
- Energy and Harmonics Program
- PowerVision Software
- Optional Programs:
  - Disturbances
  - Check-Meter
  - Fast-Check
  - Flicker
- Lightweight, portable design
- Easy-to-use push button operation
- Password protected on-screen setup
- 160x160 pixel LCD
- Backlit display
- Customized data collection
- Optional FIFO memory
- Real-time clock
- Programmable trigger-points and start/stop time
- Auto display shutoff
- Rechargeable Ni-Cad battery
- Intelligent battery charging system

### Power & Energy Measurements

- Kilowatts (kW)
- Volt-amperes (VA)
- Inductive reactive power (kvarL)
- Capacitive reactive power (kvarC)
- Power factor (PF)
- Frequency (Hz)
- Kilowatt hours (kWh)
- Reactive power per hour (kvarhL, kvarhC)

### Harmonics Measurements

- Total harmonic distortion (%THD)
- Harmonic factorization (FFT) to 51<sup>st</sup> harmonic

#### **2.1.1 Backlight**

The Model 806 power analyzer has a backlit LCD display to make it easier to read in dimly lit environments. This display can be turned off to conserve battery life.

To turn off the display backlight:

- 1) Press the off key quickly.
- 2) Pressing the off key quickly again to turn the backlight back on.

#### **2.1.2 Auto power off**

The 800 series power analyzers have an energy saving system to conserve power during data recording. After 5 minutes, if no key is pressed, the display will automatically go blank. The analyzer will continue to record data and update all of the min/max and energy values. To restore the display, press any key except for the on key. The on key is disabled when the display has been turned off to help the user differentiate between the display being off and the analyzer being off.

#### **2.1.3 Auto-detect clamps**

The power clamp adapters have a special sensor in the connector, allowing the Model 806 power analyzer to automatically detect the primary current value. Simply plug the clamp adapters into the phase or neutral current input terminals and the analyzer will detect the clamp and update any changes to the current clamp adapter values in the setup menu.

### **2.2 Display and keypad**

The model 806 has a 160x160 pixel LCD for viewing the analyzer's measurements. There are 5 basic view screens to display the analyzer's information in an easy-to-read format. Detailed information on these screens is found in section 4 of this instruction manual.

The 9-button keypad allows the user to move through the 5 display screens and access the analyzer's programming menu. Detailed information on the programming menu is found in section 5 of this instruction manual.

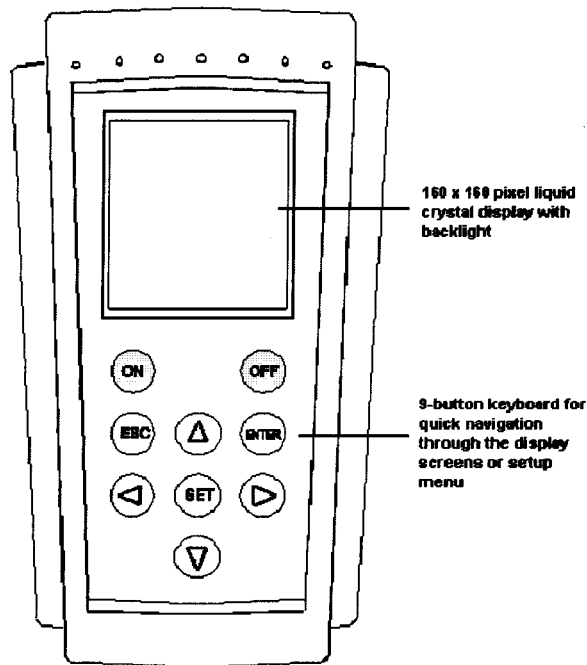

For best viewing in direct sunlight, or in dark areas, the user can adjust the display contrast. Use the left [ ] and right [ ] arrow buttons to increase or decrease the display contrast. The contrast will change while you are making the adjustment. This can also be changed from the programming menu. See section 5.3.3 of this instruction manual for more information.

### 2.3 Voltage and current input terminals

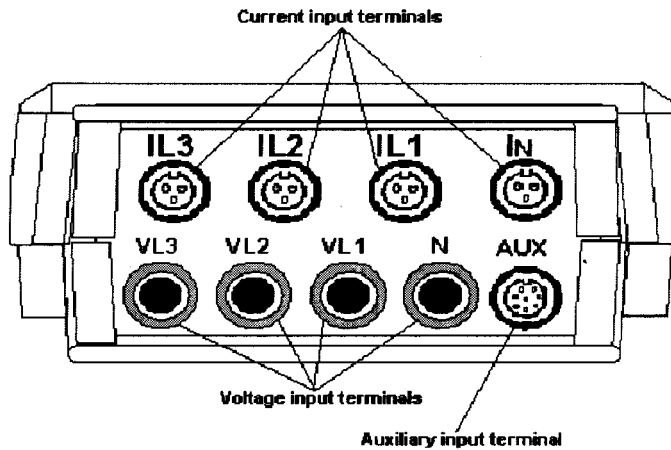

### 3. Startup

The 800 series analyzers come standard with the Energy and Harmonics program loaded onto the analyzer. Optional programs are available to expand the capabilities of your analyzer. More detailed information about these programs is located in section 11 of this instruction manual.

#### 3.1 Selecting a Program

SELECT PROGRAM
HARMONICS 7.02
EMPTY PROGRAM
EMPTY PROGRAM
LOAD PROGRAM

- 1) Press the red on button **<ON>** to power up the analyzer. This brings up the introductory screen of the analyzer, where the user can select a program or load an additional program.
- 2) Use the up [ ] and down [ ] arrow keys to move cursor through the available programs listed in the introductory screen. The cursor will automatically skip over the spaces that are currently empty and reserved for optional programs.
- 3) To select the Energy and Harmonics program, select HARMONICS and press the enter key **[ENTER]**.
- 4) If no program is selected after a few seconds, the analyzer will automatically select the program highlighted by the cursor.

#### 3.2 Loading a new program

The 800 series analyzer can hold up to 4 programs at one time. Optional programs can be loaded onto any of the available spaces on the analyzer, which are labeled as EMPTY PROGRAM on the introductory screen. The programs come loaded onto a cartridge and are downloaded onto the analyzer through the power supply/RS-232 interface.



Note: A cartridge program loader can be used on only one individual analyzer. The download of the program includes an identification step, which prohibits the download of the optional program to other analyzers. The program can be reloaded onto the original analyzer an unlimited number of times. Remember to write the serial number of your power analyzer on the cartridge loader.

To load a new program:

- 1) Turn the analyzer off
- 2) Plug the power cord into the power supply/RS-232 interface. The analyzer must have line power throughout the program loading process.
- 3) Connect the analyzer to the power supply/RS-232 interface with the interface cable.
- 4) Insert the cartridge loader into the small auxiliary input on the front of the power supply/RS-232 interface.

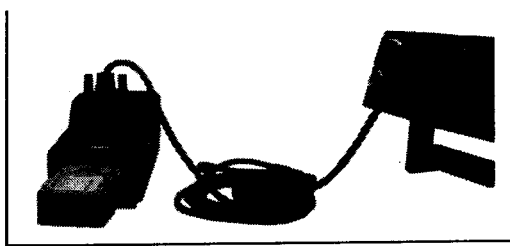

- 5) Press the red on button **[ON]** to power up the analyzer. This brings up the introductory screen of the analyzer, where the user can select a program or load an additional program.
- 6) Use the up [ ] and down [ ] arrow buttons to move cursor through the available programs listed in the introductory screen. The cursor will automatically skip over the spaces that are currently empty and reserved for optional programs.
- 7) Select LOAD PROGRAM and press enter **<ENTER>**.
- 8) Select one of the available spaces on the analyzer **<EMPTY PROGRAM>** and press enter **<ENTER>**.
- 9) **Selecting a space that is already occupied by a program will erase the program and replace it with the new program being loaded by the user.**
- 10) The power analyzer will perform a diagnostic test to ensure that the cartridge has been properly connected.
- 11) If analyzer detects the cartridge, then the program will be loaded.
- 12) Once the loading is completed, press the red off button **<OFF>** to turn the analyzer off.
- 13) When the unit is turned on again, the optional program will appear on the introductory screen.
- 14) If no program was found, or a loading error occurred, cycle the meter off and on again, and repeat the steps above.

Note: If a cartridge has already been loaded on power analyzer, it will not load onto another. In this case, the analyzer will display an error message on the screen.

### 3.3 Charging the battery

The 800 series power analyzers are equipped with an intelligent energy charging system. The analyzer continuously checks the state of the battery while it is plugged into the power supply. The charging process stops when the battery is at its maximum charge level. This increases the life of the batteries.

If the battery has been completely discharged, the charging process should last at least 3 hours with no interruption. It is important to allow a new battery a charging period of 16 hours in order to completely charge the battery.



The battery charge indication is located in the lower right-hand corner of the analyzer. The bars indicate how much charge is left in the battery.

To charge the battery:

- 1) Plug the power cord into the power supply/RS-232 interface.
- 2) Connect the analyzer to the power supply/RS-232 interface with the interface cable.
- 3) Turn the analyzer on. The analyzer must be on to charge the battery.

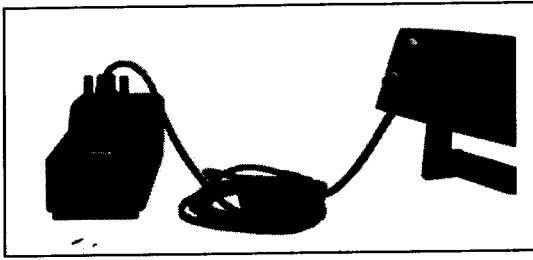

- 4) When the battery is charging, there will be a right arrow at the far left-hand side of the battery charge indicator.
- 5) After 5 minutes, if no key is pressed, the display will automatically go blank. The unit is still charging, but the analyzer has automatically shut down the display to conserve energy. For information on this auto power off feature, see section 2.1.2 of this instruction manual.

Note: The analyzer must be turned on to charge the battery.

### 3.4 Turning the analyzer off

The model 806 Power Analyzer has password protection on the off button. This keeps the analyzer from being accidentally shut down during data recording. The user can disable this option. For instructions on disabling the password refer to section 5.7 of this instruction sheet. If the password has been disabled for turning the power off, the analyzer will turn off after step #1 of the following instructions.

To turn the analyzer off:

- 1) Press and hold the off button [OFF] for a few seconds. A quick press of the off button turns the backlight on and off.
- 2) The analyzer will ask for a password to be entered.

PASSWORD

- 3) The password is 4 buttons pressed in sequence. The default password is left arrow [ ], set [SET], up arrow [ ], set [SET]. The user can change the password on the Model 806. For information on changing the password, see section 5.2.5 of this instruction manual.
- 4) After the password is entered, the analyzer will prompt the user to "press off to close".
- 5) Press the off key again to shut the analyzer off. If the off button is not pressed within a few seconds, the analyzer will return to normal operation, and this process will need to be repeated to turn the analyzer off.

#### 4. Model 806 display screens

The 800 series analyzer is portable enough to be used as a hand-held power quality meter. There are 5 basic screens to give the user real-time information on the power, energy and harmonics measurement at the power source, in the distribution system, or at the load itself. The 5 basic screens are the table, exploded view, bar graph, scope-view and setup screens. There are two additional screens, the waveform view and harmonic bar graph screens that can be accessed from the scope view screens. Each screen is described in detail in this section of the instruction manual.

To move from screen to screen, press the escape [ESC] button.

##### 4.1 Table view screen

In this screen, all available power and energy parameters are displayed in an easy-to-read table. The information provided will depend on the measurement type selected. Specific tables will be created based on the measurement type selected in the programming menu. See section 5.2.1 of this instruction manual for more information. The information displayed is independent of the information that the analyzer is recording. For example, the user does not have to record the neutral current to see it displayed in this screen.

The following is a list of the power values displayed in the table view screen:

- Voltage (V): The RMS value measured at each phase (L1, L2 & L3) and the average value of the instantaneous values of the three-phases (III).
- Current (A): The RMS value measured at each phase (L1, L2 & L3) and the average value of the instantaneous values of the three-phases (III).
- Active power (kW): The active power is calculated from instantaneous voltage and current data. The display gives the instantaneous values of the active power of each phase and also the three-phase total instantaneous active power, which is the addition of each phase value.
- Inductive reactive power (kvarL): The inductive reactive power is calculated from instantaneous voltage and current data. The display gives the instantaneous values of the inductive reactive power of each phase and also the three-phase total instantaneous inductive reactive power, which is the addition of each phase value.
- Capacitive reactive power (kvarC): The capacitive reactive power is calculated from instantaneous voltage and current data. The display gives the instantaneous values of the capacitive reactive power of each phase and also the three-phase total instantaneous capacitive reactive power, which is the addition of each phase value.
- Power factor (PF): The power factor is calculated for each phase and the three-phase average value.
- Frequency (Hz): Displays the instantaneous value of the frequency.
- Apparent power: The apparent power is the three-phase total, which is the addition of each phase value.

The energy calculations, kilowatt hour, inductive reactive and capacitive reactive power per hour are calculated based on the accumulated values from the moment that the energy counters were reset to zero. These values can be cleared on the display without affecting what the analyzer is recording. For information on how to reset the energy counters and clear these values, see section 5.6 of this instruction manual.

INST	L1	L2	L3	
Vp-n	235	233	237	235
A	31.26	30.99	30.70	30.98
kW	7,376	7,247	7,299	21.92
kvarL	0.729	0.667	0.768	2.164
kvarC	0	0	0	0
P.F.	1.00	1.00	1.00	1.00
Hz	50.0			
kVA				21.92
An				7.2
kwh		450,159		
kvarhL		92.640		
kvarhC		0.029		
05/11/98		17:19:04		

In the sample screen above, the 800 series analyzer is displaying the real-time values of a three-phase 4-wire system. The readings can be changed from real-time (instantaneous) measurements to minimum or maximum values.

To change the values:

- 1) Press the up [ ] and down [ ] arrow buttons to toggle between the instantaneous [INST], minimum [MIN], or maximum [MAX] values.
- 2) The upper left-hand corner of the table indicates which values are being displayed.
- 3) The minimum and maximum values can be cleared on the display without affecting what the analyzer is recording. For information on how to clear these values, see section 5.6 of this instruction manual.
- 4) Press the escape [ESC] button to move to the exploded view screen.

#### 4.1.1 3-phase 4-wire measurements

When a three-phase four-wire measurement type is selected in the programming menu, the analyzer will display the following information on the table view screen.

Parameter	Symbol	L1	L2	L3	Three-phase value
Phase-to-Neutral voltage	Vp-n	X	X	X	X
Current	A	X	X	X	X
Active power	kW	X	X	X	X
Inductive reactive power	kvarL	X	X	X	X
Capacitive reactive power	kvarC	X	X	X	X
Power factor	PF	X	X	X	X
Frequency	Hz	X			
Apparent power	kVA				X
Neutral current	A <sub>N</sub>				X
Kilowatt hours	kWh				X
Inductive reactive power per hour	kvarhL				X
Capacitive reactive power per hour	kvarhC				X

#### 4.1.2 3-phase 3-wire measurements

When a three-phase three-wire measurement type is selected in the programming menu, the analyzer will display the following information on the table view screen.

Parameter	Symbol	L1	L2	L3	Three-phase value
Phase-to-Phase voltage	Vp-p	X	X	X	X
Current	A	X	X	X	X
Active power	kW	X	X	X	X
Inductive reactive power	kvarL	X	X	X	X
Capacitive reactive power	kvarC	X	X	X	X
Power factor	PF	X	X	X	X
Frequency	Hz	X			
Apparent power	kVA				
Kilowatt hours	kWh				X
Inductive reactive power per hour	kvarhL				X
Capacitive reactive power per hour	kvarhC				X

#### 4.1.3 Single-phase measurements

When a single-phase measurement type is selected in the programming menu, the analyzer will display the following information on the table view screen.

Parameter	Symbol	L1
Phase-to-Phase voltage	Vp-n	X
Current	A	X
Active power	kW	X
Inductive reactive power	kvarL	X
Capacitive reactive power	kvarC	X
Power factor	PF	X
Frequency	Hz	X
Apparent power	kVA	X
Kilowatt hours	kWh	X
Inductive reactive power per hour	kvarhL	X
Capacitive reactive power per hour	kvarhC	X

#### 4.1.4 Split-phase system

When a split-phase measurement type is selected in the programming menu, the analyzer will display the following information on the table view screen.

Parameter	Symbol	L1-N	L2-N	Split-phase value L1-L2
Voltage	Vp-p	X	X	X
Current	A	X	X	X
Active power	kW	X	X	X
Inductive reactive power	kvarL	X	X	X
Capacitive reactive power	kvarC	X	X	X
Power factor	PF	X	X	X
Frequency	Hz	X		
Apparent power	kVA			X
Neutral current	A <sub>N</sub>			X
Kilowatt hours	kWh			X
Inductive reactive power per hour	kvarhL			X
Capacitive reactive power per hour	kvarhC			X

#### 4.1.5 2 wattmeter method (3 PT, 2 CT)

When the two-wattmeter measurement type (3PT, 2CT) is selected in the programming menu, the analyzer will display the following information on the table view screen.

Parameter	Symbol	L1	L2	L3	Three-phase value
Phase-to-Neutral voltage	Vp-p	X	X	X	X
Current	A	X	X	X	X
Active power	kW	X	X	X	X
Inductive reactive power	kvarL	X	X	X	X
Capacitive reactive power	kvarC	X	X	X	X
Power factor	PF	X	X	X	X
Frequency	Hz	X			
Apparent power	kVA				X
Kilowatt hours	kWh				X
Inductive reactive power per hour	kvarhL				X
Capacitive reactive power per hour	kvarhC				X

## 4.2 Exploded view screen

In the exploded view screen, any three parameters can be selected and displayed in large characters for easy viewing. These are instantaneous measurements and will change in real-time as the system changes.

Note: Any three parameters can be selected regardless of the measurement type, or parameters chosen for data recording.

INST	HARMONICS
Vp-n L1	<b>220</b>
Vp-n L2	<b>221</b>
Vp-n L3	<b>224</b>

To change these parameters:

- 1) Press the enter button **[ENTER]**. This brings up a grid showing all of the available parameters.
- 2) The selected parameters will be highlighted in black.
- 3) Use the up **[↑]**, down **[↓]**, left **[←]**, and right **[→]** arrow buttons to move the cursor through the parameters.
- 4) Pressing the set **[SET]** button selects, or de-selects a parameter. Pressing set while on "CLEAR ALL " at the bottom of the display clears all parameters.
- 5) Only three parameters may be chosen. If an additional parameter is accidentally selected, the analyzer will display the "OUT OF RANGE" error message at the bottom of the screen. This message will disappear after a few seconds.
- 6) After all three parameters have been selected, press the enter **[ENTER]** button to accept the new parameters. This will return the user to the exploded view screen and the new parameters will be displayed on the screen.
- 7) Pressing the escape **[ESC]** button will return the user to the exploded view screen without modifying the parameters.
- 8) Press the escape **[ESC]** button from the exploded view screen to move to the bar graph screen.

Note: This screen can also be changed from the programming menu. For more information see section 5.3.2 of this instruction manual.

### 4.3 Bar graph screen

The bar graph screen gives a graphic representation of a single parameter on all three-phases simultaneously. These are instantaneous measurements and will change in real-time as the system changes.

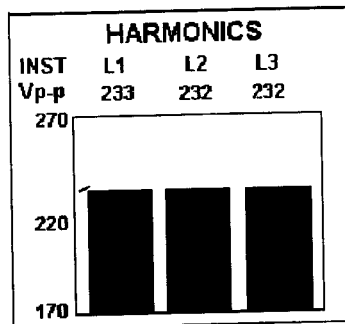

To change the parameter and the bar graph scale:

- 1) Press the enter button **[ENTER]**. This brings up a selection box with the existing selection highlighted.
- 2) Use the up **[↑]** and down **[↓]** arrow buttons to move through the available parameters.
- 3) After the parameter has been selected, press the enter **[ENTER]** button. This brings up the zero-scale selection box. The existing zero-scale selection will be highlighted.
- 4) In the lower right-hand corner of the screen is a numerical keypad. Use the up **[↑]**, down **[↓]**, left **[←]**, and right **[→]** arrow buttons to move the cursor through the keypad.
- 5) Press the set **[SET]** button to select a new numerical value. You can change the zero-scale to a negative number by selecting the **±** symbol. A decimal point may also be used in the zero-scale by selecting the decimal point **[.]**.
- 6) To delete a number, select the backspace icon **[←]** and press the set button.
- 7) After the zero-scale value has been selected, press the enter **[ENTER]** button. This brings up the full-scale selection box. The existing full-scale selection will be highlighted.
- 8) Press the set **[SET]** button to select a new numerical value. You can change the full-scale to a negative number by selecting the **±** symbol. A decimal point may also be used in the full-scale by selecting the decimal point **[.]**.
- 9) After the full-scale value has been selected, press the enter **[ENTER]** button. This will return the user to the bar graph screen and the new scaling will be applied to the graph. If the full-scale value entered is lower than the zero-scale value, the analyzer will display the "ZERO must be lower than FULL SCALE" error message at the bottom of the screen. This message will disappear after a few seconds and return the user to the zero-scale selection.
- 9) Pressing the escape **[ESC]** button any time during this process will return the user to the bar graph screen without modifying the graph.
- 10) Press the escape **[ESC]** button from the bar graph screen to move to the scope view screen.

Note: This screen can also be changed from the programming menu. For more information see section 5.3.1 of this instruction manual.

#### 4.4.1 Waveform zoom

The waveform zoom screen gives an exploded view of any voltage or current waveform. This is a captured measurement and will not change in real-time as the system changes. The left arrow [ ] on the display indicates which specific waveform is displayed on the screen.

The left [ ], and right [ ] arrow buttons move the cursor along the time axis of the waveform. The measurement value, located to the left of the grid, will change based on the position of the cursor as it passes through the waveform.

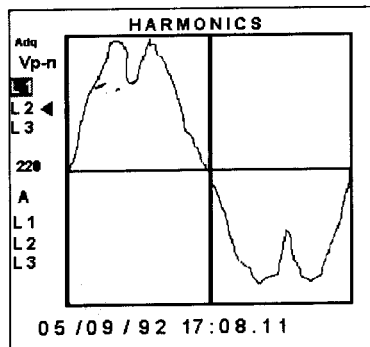

To capture new measurements on the waveform, use the up [ ] and down [ ] arrow buttons to move the cursor to the acquire icon [Adq] and press the enter [ENTER] button. The graphic representation of the new waveform will be displayed on the screen.

To change to a different voltage or current waveform while remaining in the waveform zoom screen, use the up [ ] and down [ ] arrow buttons to move the cursor to any voltage or current phase, and press the enter [ENTER] button.

To enter the harmonic bar graph screen to breakdown the harmonic content of the distortion, press the enter [ENTER] button.

Press the escape [ESC] button from the waveform zoom screen to move to the setup screen.

#### 4.4.2 Harmonic bar graph

For the harmonic bar graph screen, the analyzer performs an FFT (Fast Fourier Transform) and displays a histogram display to graphically display the harmonic content from the 1<sup>st</sup> to the 50<sup>th</sup> Harmonic. The left arrow [ ] on the display indicates which specific voltage or current phase is being broken down. This is a captured measurement and will not change in real-time as the system changes.

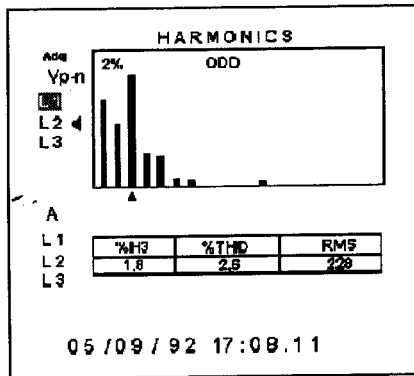

To view the percentage of distortion on the individual odd (or even) harmonic, use the left [ ] and right [ ] arrow buttons to move the cursor [ ] along the bottom of the histogram.

To refresh the screen with new harmonic content of the waveform, use the up [ ] and down [ ] arrow buttons to move the cursor to the acquire icon [Adq] and press the enter [ENTER] button. The graphic representation of the new waveform will be displayed on the screen.

To change to a different voltage or current waveform while remaining in the waveform zoom screen, use the up [ ] and down [ ] arrow buttons to move the cursor to any voltage or current phase, and press the enter [ENTER] button.

To toggle between the even and odd harmonics, [ ] and down [ ] arrow buttons to move the cursor to the top of the display [ODD] and press the enter [ENTER] button. This will change the FFT from the individual odd harmonics to the individual even harmonics. Pressing the enter button again, while the cursor is on [EVEN], will return the FFT to the individual odd harmonics.

To return to the scope view screen to get a graphic representation of the voltage and current waveforms on all three-phases simultaneously, press the enter [ENTER] button.

Press the escape [ESC] button from the harmonic bar graph screen to move to the setup screen.

#### 4.5 Setup screen

In the setup screen, the key recording parameters are displayed to let the user know how the analyzer has been setup for data collection. Additional information on these recording parameters is located in the programming menu.

SETUP	
Measure:	3 $\Phi$ 3 Wire 1V/1V 1000A - I <sub>N</sub> =100A
File:	TEST .STD
00:00:20	Harm.50
Linear	
RT	0d:03h:22m:40s
Trigger:	Auto
0	0
00:00:00	00:00:00
00:00:00	00:00:00
Com:	9600 / NO / 8 / 1

SETUP	
Measure:	<i>Measurement type</i> <i>Voltage ratio</i> <i>Clamp adapter ratio</i>
File:	<i>File name</i> <i>File extension</i>
<i>Period</i>	<i>Harmonics</i>
<i>Memory type</i>	
RT	<i>Available recording time</i>
Trigger:	<i>Parameter</i>
<i>Max value</i>	<i>Min value</i>
<i>Date on</i>	<i>Time on</i>
<i>Date off</i>	<i>Time off</i>
<i>Communication parameter</i>	

The following information is displayed on this screen:

- **Measurement type:** This determines what information will be displayed in the table view screen, and what measurements may be taken during data collection. See section 5.2.1 for more information.
- **Voltage ratio:** This ratio may be changed in the event a voltage transformer is used. See section 5.2.1 for more information.
- **Clamp adapter ratio:** These are the values of the phase current clamp adapters and the neutral current clamp adapter. See section 5.2.1 for more information.
- **File name:** This is the name of the file that is being used for data recording. See section 5.2.2 for more information.
- **File extension:** For the model 806 analyzer, this will always be a standard file extension [**.STD**].
- **Period:** This is the user-selected recording period for data collection. See section 5.2.2 for more information.
- **Harmonics:** This is the level of harmonics that is being recorded by the analyzer for data collection. See section 5.2.2 for more information.
- **Memory type:** This lets the user know if the analyzer has been set for a linear recording, or a cyclical recording where data is overwritten when the memory is full. See section 5.2.2 for more information.
- **Available recording time:** The analyzer will automatically calculate how much recording time is available based on the available memory, number of recording parameters selected and the recording period.
- **Trigger parameter:** This is the measurement parameter selected to trigger recording by the analyzer. See section 5.2.2 for more information.
- **Maximum and minimum trigger values:** If a trigger parameter has been set, these are the maximum and minimum value points that will trigger data collection. See section 5.2.2 for more information.
- **Trigger date/time on and date/time off:** If a trigger date/time has been set, this is the date/time that data collection will begin and end. See section 5.2.2 for more information.
- **Communication parameters:** This is the communication protocol that has been established for downloading data to the computer. If a trigger parameter has been set, these are the maximum and minimum value points that will trigger data collection. See section 5.2.3 for more information.

Press the escape [**ESC**] button from the setup screen to move to the table view screen.

#### 4.5 Setup screen

In the setup screen, the key recording parameters are displayed to let the user know how the analyzer has been setup for data collection. Additional information on these recording parameters is located in the programming menu.

SETUP	
Measure:	3 $\Phi$ 3 Wire 1V/1V 1000A - I <sub>N</sub> =100A
File:	TEST .STD
00:00:20	Harm.50
Linear	
RT	0d:03h:22m:40s
Trigger:	Auto
0	0
00/00/00	00:00:00
00/00/00	00:00:00
Com:	9600 / NO / 8 / 1

SETUP	
Measure:	<i>Measurement type</i> <i>Voltage ratio</i> <i>Clamp adapter ratio</i>
File:	<i>File name</i> <i>File extension</i>
<i>Period</i>	<i>Harmonics</i>
<i>Memory type</i>	
RT	<i>Available recording time</i>
Trigger:	<i>Parameter</i>
<i>Max value</i>	<i>Min value</i>
<i>Date on</i>	<i>Time on</i>
<i>Date off</i>	<i>Time off</i>
<i>Communication parameter</i>	

The following information is displayed on this screen:

- **Measurement type:** This determines what information will be displayed in the table view screen, and what measurements may be taken during data collection. See section 5.2.1 for more information.
- **Voltage ratio:** This ratio may be changed in the event a voltage transformer is used. See section 5.2.1 for more information.
- **Clamp adapter ratio:** These are the values of the phase current clamp adapters and the neutral current clamp adapter. See section 5.2.1 for more information.
- **File name:** This is the name of the file that is being used for data recording. See section 5.2.2 for more information.
- **File extension:** For the model 806 analyzer, this will always be a standard file extension [**.STD**].
- **Period:** This is the user-selected recording period for data collection. See section 5.2.2 for more information.
- **Harmonics:** This is the level of harmonics that is being recorded by the analyzer for data collection. See section 5.2.2 for more information.
- **Memory type:** This lets the user know if the analyzer has been set for a linear recording, or a cyclical recording where data is overwritten when the memory is full. See section 5.2.2 for more information.
- **Available recording time:** The analyzer will automatically calculate how much recording time is available based on the available memory, number of recording parameters selected and the recording period.
- **Trigger parameter:** This is the measurement parameter selected to trigger recording by the analyzer. See section 5.2.2 for more information.
- **Maximum and minimum trigger values:** If a trigger parameter has been set, these are the maximum and minimum value points that will trigger data collection. See section 5.2.2 for more information.
- **Trigger date/time on and date/time off:** If a trigger date/time has been set, this is the date/time that data collection will begin and end. See section 5.2.2 for more information.
- **Communication parameters:** This is the communication protocol that has been established for downloading data to the computer. If a trigger parameter has been set, these are the maximum and minimum value points that will trigger data collection. See section 5.2.3 for more information.

Press the escape [**ESC**] button from the setup screen to move to the table view screen.

## 4.6 Recording messages

The power analyzer will display a variety of messages on the screen of the analyzer to let the user know the status of the data collection. These messages are displayed in the lower left-hand corner of the screen, and will show up on any of the display screens.

- **STOP:** The analyzer is not recording data.
- **RECORD:** The analyzer is recording data.
- **TRIG?:** Trigger conditions have not been met. No data is being recorded.
- **M. Full:** The memory is full. No data is being recorded.
- **M.Error:** There is an error in the memory. The memory must be formatted.

## 5. Programming the 806

The 800 series analyzer is also powerful enough to be used for in-depth analysis of power quality and energy management issues. Its 1MB of memory is completely customizable, giving the user the option to record any number of parameters for any length of time. Trigger points can also be used to customize the data collection. Setting minimum and maximum threshold values that trigger recording, result in data collection only when a potential problem has been identified. This extends the memory of the analyzer, and makes it easier to sort through the data during the analysis phase.

### 5.1 Entering the programming menu

The programming menu is password protected to prevent unauthorized access and accidental changes to the analyzer's setup options. The programming menu can be accessed from any display screen.

To access the programming menu:

- 1) Press the set button **[SET]**.
- 2) The analyzer will ask for a password to be entered.

**PASSWORD**

- 3) The password is 4 buttons pressed in sequence. The default password is left arrow [ **←** ], set **[SET]**, up arrow [ **↑** ], set **[SET]**. The user can change the password on the Model 806. For information on changing the password, see section 5.2.5 of this instruction manual.
- 4) After the password is entered, the analyzer will bring up the programming menu. The password can be changed, allowing the user to select the password. See section 5.2.5 for more information.

The programming menu consists of 6 main menu options, which allow the user to program various aspects of the analyzer's recording parameters. Each menu is discussed separately in the following sections. Section 11 of this instruction manual contains a quick reference guide that shows all menu and sub-menu options, the available selections, and the factory default settings for each menu option. If the factory default settings are satisfactory, you can simply access the run menu and begin recording right away.

SETUP
DISPLAY
RUN
FILES
CLEAR
OFF

☞ Programming Menu

To enter a menu, use the up [ ] and down [ ] arrow buttons to move through the available parameters and press the enter [ENTER] button.

To exit the programming menu:

- 1) Press the escape [ESC] button.
- 2) If nothing has been changed, the analyzer will return to the display screens.
- 3) If a parameter has been changed, the analyzer will ask for a confirmation to verify that the user wished to make a change.
- 4) Use the left [ ] and right [ ] arrow buttons to choose either yes or no, and press enter.
- 5) If **NO** is selected, the user will be returned to the display screens without making any changes.
- 6) If **YES** is selected, the programming changes will be made, and the user will be returned to the display screens.
- 7) Changing some parameters will drastically alter the nature of the data being recorded by the analyzer, for example, changing the measurement type from 3 $\Phi$  3-wire to 1 $\Phi$ . In these instances, the analyzer will ask the user if they wish to overwrite the file with the new setup. Use the left [ ] and right [ ] arrow buttons to choose either yes or no, and press enter.
- 8) If **NO** is selected, the analyzer will remain in the programming menu to create a new file with the updated parameters and continue recording. The PowerVision™ software has the capabilities of opening more than one file, allowing the user to combine data from both files for analysis.
- 9) If **YES** selected, the analyzer will overwrite the file and return the analyzer to the display screens. Any data that has been previously recorded on this file will be lost.
- 10) If the file type has been changed from either cyclical to linear, or linear to cyclical, the analyzer's memory will need to be formatted. In these instances, the analyzer will ask the user if they wish to format the memory. Use the left [ ] and right [ ] arrow buttons to choose either yes or no, and press enter. (See section 5 on file name and type for more information)
- 11) If **NO** is selected, the analyzer will remain in the programming menu as this change cannot be made without formatting the memory. Change the file type back to the original setting before exiting the programming menu if you do not wish to format the memory.
- 12) If **YES** is selected, the analyzer will format the memory and return the analyzer to the display screens. Any data that has been previously recorded on this file will be lost.

## 5.2 Setup menu

The setup menu consists of 6 main menu options, which allow the user to customize the analyzer's data collection. Each menu is discussed separately in this sections.

To access the setup menu, use the up [ ] and down [ ] arrow buttons to move the cursor through the available parameters of the programming menu, select **SETUP** and press the enter [ENTER] button.

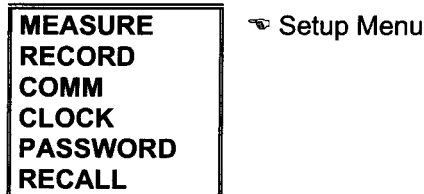

To enter a menu, use the up [ ] and down [ ] arrow buttons to move through the available parameters and press the enter [ENTER] button.

To return to the main programming menu, press either the left arrow [ ] or escape [ESC] button.

### 5.2.1 Measure

The measure menu contains the parameters for setting up the voltage and current measurement options.



**Wiring:** This is the type of circuit being measured. The circuit type determines what measurement parameters are available and how the analyzer will calculate the system measurement values.

Wiring options:

- 3 $\Phi$  3-wire – three-phase three-wire circuits
- 3 $\Phi$  4-wire – three phase four wire circuits  $\Rightarrow$  Factory default setting
- 3PT-2CT – 2 wattmeter method
- 1 $\Phi$  – single-phase circuits
- 1 $\Phi$  Split – split-phase circuits

To change the wiring type:

- 1) Use the up [ ] and down [ ] arrow buttons to highlight **WIRING** and press the enter [ENTER] button. This brings up a selection box with the existing wiring selection highlighted.
- 2) Use the up [ ] and down [ ] arrow buttons to move through the available options and press the enter [ENTER] button to select an option.
- 3) To return to the measure menu without selecting an option, press the escape [ESC] button.

**PT/CT:** These are the ratios for the voltage and current measurements. Setting the PT ratio allows the user to hook the analyzer up to a voltage transformer, stepping down the voltage coming in without changing the actual voltage on the display or in the memory of the analyzer. The auto-detect clamp feature of the Model 806 analyzer CT automatically sets the CT ratios of the analyzer. If the user is manually setting these ratios, they will only be prompted for a primary value. All of the power clamp adapters supplied by IDEAL for the 800 series analyzers have a 2V output. The secondary ratio of the CT is assumed to be 2V.

#### PT/CT settings:

- Prim.V – primary voltage in the PT ratio ↻ Factory default setting is 1
- Sec. V – secondary voltage in the PT ratio ↻ Factory default setting is 1
- Prim. I – Primary current for the power clamp adapters (L1, L2, L3) ↻ Factory default setting is 1000
- Prim. I<sub>N</sub> - Primary current for the neutral clamp adapter ↻ Factory default setting is 100

#### To adjust the PT/CT settings:

- 1) Use the up [ ] and down [ ] arrow buttons to highlight **PT/CT** and press the enter **[ENTER]** button. This brings up the first PT/CT setting (Prim. V)
- 2) In the lower right-hand corner of the screen is a numerical keypad. Use the up [ ], down [ ], left [ ], and right [ ] arrow buttons to move the cursor through the keypad. The existing numerical value for the Prim. V setting will be highlighted.
- 3) Press the set **[SET]** button to select a new numerical value. You can change to a negative number by selecting the  $\pm$  symbol. A decimal point may also be used by selecting the decimal point [.].
- 4) To delete a number, select the backspace icon [←] and press the set button.
- 5) After the Prim. V value has been selected, press the enter **[ENTER]** button. This brings up the next PT/CT option, Sec. V. The existing numerical value will be highlighted.
- 6) Use the up [ ], down [ ], left [ ], and right [ ] arrow buttons to move the cursor through the keypad. Press the set **[SET]** button to select a new numerical value. You can change to a negative number by selecting the  $\pm$  symbol. A decimal point may also be used by selecting the decimal point [.]. To delete a number, select the backspace icon [←] and press the set button.
- 7) After the Sec. V value has been selected, press the enter **[ENTER]** button. This brings up the next PT/CT option, Prim. I. The existing numerical value will be highlighted.
- 8) Use the up [ ], down [ ], left [ ], and right [ ] arrow buttons to move the cursor through the keypad. Press the set **[SET]** button to select a new numerical value. You can change to a negative number by selecting the  $\pm$  symbol. A decimal point may also be used by selecting the decimal point [.]. To delete a number, select the backspace icon [←] and press the set button.
- 9) After the Prim. I value has been selected, press the enter **[ENTER]** button. This brings up the next PT/CT option, Prim. I<sub>N</sub>. The existing numerical value will be highlighted.
- 10) Use the up [ ], down [ ], left [ ], and right [ ] arrow buttons to move the cursor through the keypad. Press the set **[SET]** button to select a new numerical value. You can change to a negative number by selecting the  $\pm$  symbol. A decimal point may also be used by selecting the decimal point [.]. To delete a number, select the backspace icon [←] and press the set button.
- 11) After the Prim. I<sub>N</sub> value has been selected, press the enter **[ENTER]** button to save the changes and return to the measure menu.
- 12) To skip a setting without changing the value, press either the escape **[ESC]** or enter **[ENTER]** button.

To return to the setup menu, press either the left arrow [ ] or escape **[ESC]** button.

### 5.2.2 Record

Record is the section of the menu for setting up the analyzer's recording options.



↻ Record Menu

**Period:** This is the recording period for data collection. The analyzer records the average values over the recording period at the end of every period. Harmonics values are captured at the end of every recording period. Throughout the recording period, the analyzer will also monitor the line to capture any minimum and maximum values. These values will be recorded at the end of every recording period and then reset to capture new minimum and maximum values in the next recording period.

Period setting format:

- hour:minute:second – The available recording period is from 1 second up to 4 hours ↗ Factory default setting is 15 min.

To change the recording period:

- 1) Use the up [ ] and down [ ] arrow buttons to highlight **PERIOD** and press the enter [ENTER] button. This brings up the existing period setting.
- 2) The hour setting is highlighted. Use the up [ ] and down [ ] arrow buttons to adjust the setting. Chose from 0 to 4 hours.
- 3) Press the right arrow [ ] button to move to the minute setting. Use the up [ ] and down [ ] arrow buttons to adjust the setting. Chose from 0 to 59 minutes.
- 4) Press the right arrow [ ] button to move to the second setting. Use the up [ ] and down [ ] arrow buttons to adjust the setting. Chose from 0 to 59 seconds.
- 5) Press the enter [ENTER] button to save your changes and return to the record menu.
- 6) Press the escape [ESC] button to return to the record menu without saving any changes.

**Trigger:** This is the measurement values or time values that will trigger data collection to begin. When a level trigger is selected, the analyzer will record data that rises above or falls below the selected maximum and minimum parameter value. When a time trigger is selected, the analyzer will begin recording at the date/time on setting and end recording at the date/time off setting. The trigger can be a level trigger, a time trigger or both.

Level settings:

- Param. – measurement parameter that will trigger data recording
  - Auto – automatic recording, no level trigger ↗ Factory default setting
  - KVA – apparent power
  - Hz - frequency
  - PF – power factor
  - KvarC – capacitive reactive power
  - KvarL – inductive reactive power
  - KW – true power
  - A - current
  - Vp-n – phase-neutral voltage
  - Vp-p – phase-phase voltage
- Max – maximum parameter value, recording begins when measurement rises above this value
- Min - minimum parameter value, recording when measurement falls below this value

To change the level settings:

- 1) Use the up [ ] and down [ ] arrow buttons to highlight **LEVEL** and press the enter [ENTER] button. This brings up a selection box with the existing level selection highlighted.
- 2) Use the up [ ] and down [ ] arrow buttons to move through the available level parameters.
- 3) After the parameter has been selected, press the enter [ENTER] button. This brings up the max selection box. The existing maximum value will be highlighted.
- 4) In the lower right-hand corner of the screen is a numerical keypad. Use the up [ ], down [ ], left [ ], and right [ ] arrow buttons to move the cursor through the keypad.
- 5) Press the set [SET] button to select a new numerical value. You can change the maximum value to a negative number by selecting the ± symbol. A decimal point may also be used by selecting the decimal point [.]
- 6) To delete a number, select the backspace icon [←] and press the set button.
- 7) After the maximum value has been selected, press the enter [ENTER] button. This brings up the min selection box. The existing minimum value will be highlighted.
- 8) Use the up [ ], down [ ], left [ ], and right [ ] arrow buttons to move the cursor through the numerical keypad.

- 9) Press the set **[SET]** button to select a new numerical value. You can change the minimum value to a negative number by selecting the  $\pm$  symbol. A decimal point may also be used by selecting the decimal point **[.]**.
- 10) To delete a number, select the backspace icon **[←]** and press the set button.
- 11) After the minimum value has been selected, press the enter **[ENTER]** button. This will return the user to the trigger menu.
- 12) To skip a setting without changing the value, press either the escape **[ESC]** or enter **[ENTER]** button.

#### Time settings:

- Time on: day/month/year, hour:minute:second – set the date and time to begin recording, all zeros in the date and time indicate that no time trigger has been selected ☞ Factory default setting is 00/00/00, 00:00:00
- Time off: day/month/year, hour:minute:second – set the date and time to end recording, all zeros in the date and time indicate that no time trigger has been selected ☞ Factory default setting is 00/00/00, 00:00:00

#### To change the time settings:

- 1) Use the up **[↑]** and down **[↓]** arrow buttons to highlight **TIME** and press the enter **[ENTER]** button. This brings up the time on selection box.
- 2) The day setting is highlighted. Use the up **[↑]** and down **[↓]** arrow buttons to adjust the setting. Chose from 0 to 31 days.
- 3) Press the right arrow **[→]** button to move to the month setting. Use the up **[↑]** and down **[↓]** arrow buttons to adjust the setting. Chose from 0 to 12 months.
- 4) Press the right arrow **[→]** button to move to the year setting. Use the up **[↑]** and down **[↓]** arrow buttons to adjust the setting. Chose from 00 to 99.
- 5) Press the right arrow **[→]** button to move to the hour setting. Use the up **[↑]** and down **[↓]** arrow buttons to adjust the setting. The hour setting is a military time format, so chose from 0 to 24 hours.
- 6) Press the right arrow **[→]** button to move to the minute setting. Use the up **[↑]** and down **[↓]** arrow buttons to adjust the setting. Chose from 0 to 59 minutes.
- 7) Press the right arrow **[→]** button to move to the second setting. Use the up **[↑]** and down **[↓]** arrow buttons to adjust the setting. Chose from 0 to 59 seconds.
- 8) Press the enter **[ENTER]** button to save your changes and return to the record menu.
- 9) Press the escape **[ESC]** button to return to the record menu without saving any changes.

To return to the setup menu, press either the left arrow **[←]** or escape **[ESC]** button.

**Name:** This is the name of the file and the file type created by the user for data recording. Up to 8 alphanumeric characters can be used to describe the contents of the file. Files can be either a linear or cyclical file type. In a linear file type, the analyzer will continue recording until the 1MB of memory is full. In a cyclical file type, the analyzer will begin overwriting the first data collected with the most recent data. This is often called first in first out (FIFO) memory.

#### File type options:

- Linear: when memory is full, analyzer will stop recording ☞ Factory default setting
- Cyclical: when memory is full, analyzer will overwrite first data with most recent data

**Note:** When a cyclical file type is selected, the analyzer can only hold one file in its memory. In a linear file type, several different files may be saved in the internal memory.

To choose a file name and file type::

- 1) Use the up [ ] and down [ ] arrow buttons to highlight **NAME** and press the enter [ENTER] button. This brings up a selection box with the existing file name highlighted.
- 2) Below the selection box is a keyboard and numerical keypad. Use the up [ ], down [ ], left [ ], and right [ ] arrow buttons to move the cursor through the keypad.
- 3) Press the set [SET] button to select a new alphanumerical value.
- 4) Select caps lock [LOCK] to toggle between upper and lower case letters.
- 5) Insert a space by selecting the space bar [SPAC].
- 6) To delete a character, select the backspace icon [←] and press the set button.
- 7) After the name has been selected, press the enter [ENTER] button. This will save the name and bring up the file type selection box. To select the file type without changing the name, press either the escape [ESC] button.
- 8) Use the up [ ] and down [ ] arrow buttons to choose either linear or cyclical and press enter.
- 9) The user will be returned to the record menu.
- 10) If the file type has been changed from either cyclical to linear, or linear to cyclical, the analyzer's memory will need to be formatted. In these instances, the analyzer will ask the user if they wish to format the memory. Use the left [ ] and right [ ] arrow buttons to choose either yes or no, and press enter.
- 11) If **NO** is selected, the analyzer will remain in the programming menu as this change cannot be made without formatting the memory. Change the file type back to the original setting before exiting the programming menu if you do not wish to format the memory.
- 12) If **YES** is selected, the analyzer will format the memory and return the analyzer to the display screens. Any data that has been previously recorded on this file will be lost.
- 13) Press the escape [ESC] button to return to the record menu without saving any changes.

Note: If a duplicate file name is chosen, the analyzer will verify that the user wishes to overwrite the file.

Note: In a cyclical file type, all memory is allocated to the new file. All files must be downloaded prior to the setup of a cyclical file.

To return to the setup menu, press either the left arrow [ ] or escape [ESC] button.

**Param:** This is the section of the menu where the user selects the measurement parameters that will be recorded by the analyzer. Any number of instantaneous, minimum, maximum and harmonics values can be selected. The factory default values will be based on the measurement type selected. For example, if a single-phase measurement type is selected, then the analyzer will automatically select all of the L1 measurement values. See section 4.1 for the available measurement parameters for the various measurement types.

Available measurement options:

- Instantaneous measurements- all power and energy parameters available for the selected measurement type
- Maximum measurements – all power parameters available for the selected measurement type
- Minimum measurements - all power parameters available for the selected measurement type
- Harmonic measurements –voltage and/or current harmonics measurements to either the 30<sup>th</sup> or 50<sup>th</sup> harmonic

To choose the measurement parameters:

- 1) Use the up [ ] and down [ ] arrow buttons to highlight **PARAM** and press the enter [**ENTER**] button. This brings up a grid showing all of the available instantaneous parameters.
- 2) The selected parameters will be highlighted in black.
- 3) Use the up [ ], down [ ], left [ ], and right [ ] arrow buttons to move the cursor through the parameters.
- 4) Pressing the set [**SET**] button selects, or de-selects a parameter. Pressing set while on "CLEAR ALL" at the bottom of the display clears all parameters.
- 5) After the desired instantaneous parameters have been selected, move the cursor to the upper left-hand corner [**INST**] and press set . This will bring up a grid showing all of the available maximum parameters. The selected parameters will be highlighted in black and **MAX** will be displayed in the upper left-hand corner of the screen.
- 6) Use the up [ ], down [ ], left [ ], and right [ ] arrow buttons to move the cursor through the available maximum parameters.
- 7) Pressing the set [**SET**] button selects, or de-selects a parameter. Pressing set while on "CLEAR ALL" at the bottom of the display clears all parameters.
- 8) After the desired maximum parameters have been selected, move the cursor to the upper left-hand corner [**MAX**] and press set . This will bring up a grid showing all of the available minimum parameters. The selected parameters will be highlighted in black and **MIN** will be displayed in the upper left-hand corner of the screen.
- 9) Use the up [ ], down [ ], left [ ], and right [ ] arrow buttons to move the cursor through the available minimum parameters.
- 10) Pressing the set [**SET**] button selects, or de-selects a parameter. Pressing set while on "CLEAR ALL" at the bottom of the display clears all parameters.
- 11) After the desired maximum parameters have been selected, move the cursor to the upper left-hand corner [**MIN**] and press set . This will bring up a grid showing all of the available minimum parameters. The selected parameters will be highlighted in black and **HARM** will be displayed in the upper left-hand corner of the screen.
- 12) Use the up [ ], down [ ], left [ ], and right [ ] arrow buttons to move the cursor through the parameters.
- 13) After the desired parameters have been selected, select the desired order of harmonics. Choosing 30 selects the individual harmonics to the 30th and 50 selects the individual harmonics to the 50th.
- 14) Press the enter [**ENTER**] button to save your changes and return to the record menu.
- 15) Press the escape [**ESC**] button to return to the record menu without saving any changes.

To return to the setup menu, press either the left arrow [ ] or escape [**ESC**] button.

### 5.2.3 Comm

Comm is the section of the menu to set the communication protocols for downloading data. During this process, the PowerVision™ software will auto-detect the analyzer at all possible baud rates, so it is not necessary to change these parameters, however a faster baud rate may be desired.

Communication parameters:

- Baud rate: choose from 1200, 2400, 4800, 9600, 19200, 38400 ↻ Factory default setting is 9600
- Parity: choose from no, odd, even ↻ Factory default setting is no
- Length: this is set at 8 ↻ Factory default setting is 8
- Stop bits: chose from 1, 2 ↻ Factory default setting is 1

To change the communication parameters:

- 1) Use the up [ ] and down [ ] arrow buttons to highlight **COMM** and press the enter [ENTER] button. This brings up the communication parameter selection box.
- 2) The baud rate setting is highlighted. Use the up [ ] and down [ ] arrow buttons to adjust the setting. Chose from 1200 to 38400.
- 3) Press the right arrow [ ] button to move to the parity setting. Use the up [ ] and down [ ] arrow buttons to adjust the setting. Chose either no, odd or even.
- 4) Press the right arrow [ ] button to move to the stop bits setting. The length setting will be skipped, because it cannot be changed.
- 5) Use the up [ ] and down [ ] arrow buttons to adjust the stop bits setting. Chose either 1 or 2.
- 6) Press the enter [ENTER] button to save your changes and return to the setup menu.
- 7) Press the escape [ESC] button to retrun to the setup menu without saving any changes.

**NOTE:** Nearly every computer uses the fastest speed selectable, which is 38400 baud. A slower speed will substantially increase the time required to download a file to your computer. All modern PCs will support a baud rate of 38400. Try the fastest rate first.

To return to the main programming menu, press either the left arrow [ ] or escape [ESC] button.

#### 5.2.4 Clock

Clock is the section of the menu to set the date and time information. The user can select the date format, choosing from either American or European format, and set the date and time.

Clock type options:

- dd/mm/yy: European date format
- mm/dd/yy: American date format ☞ Factory default setting

To change the clock type and date/time information:

- 1) Use the up [ ] and down [ ] arrow buttons to highlight **CLOCK** and press the enter [ENTER] button. This brings up the clock type selection box.
- 2) Use the up [ ] and down [ ] arrow buttons to adjust the setting. Chose either date format and press the enter [ENTER] button. This brings up the clock settings.
- 3) If you chose the American date format, the month setting will be highlighted. Use the up [ ] and down [ ] arrow buttons to adjust the setting. Chose from 0 to 12 months. If the European date format was selected, the first setting will be the day setting.
- 4) Press the right arrow [ ] button to move to the day setting. Use the up [ ] and down [ ] arrow buttons to adjust the setting. Chose from 0 to 31 days. If the European date format was selected, the second setting will be the month setting.
- 5) Press the right arrow [ ] button to move to the year setting. Use the up [ ] and down [ ] arrow buttons to adjust the setting. Chose from 00 to 99.
- 6) Press the right arrow [ ] button to move to the hour setting. Use the up [ ] and down [ ] arrow buttons to adjust the setting. The hour setting is a military time format, so chose from 0 to 24 hours.
- 7) Press the right arrow [ ] button to move to the minute setting. Use the up [ ] and down [ ] arrow buttons to adjust the setting. Chose from 0 to 59 minutes.
- 8) Press the right arrow [ ] button to move to the second setting. Use the up [ ] and down [ ] arrow buttons to adjust the setting. Chose from 0 to 59 seconds.
- 9) Press the enter [ENTER] button to save your changes and return to the setup menu.
- 10) Press the escape [ESC] button to retrun to the setup menu without saving any changes.

To return to the main programming menu, press either the left arrow [ ] or escape [ESC] button.

### 5.2.5 Password

Password is the section of the menu to customize the password to protect the analyzer from unauthorized access. **If you change the password, and forget the change, you will have to consult the factory for assistance in retrieving the new password.**

To change the password:

- 1) Use the up [ ] and down [ ] arrow buttons to highlight **PASSWORD** and press the enter [ENTER] button. This brings up the password selection box.
- 2) The analyzer will prompt the user for the old password.
- 3) The password is 4 buttons pressed in sequence. The default password is left arrow [ ], set [SET], up arrow [ ], set [SET].
- 4) If the password is entered incorrectly, the analyzer will display an error message "Incorrect old password" and return the user to the setup menu.
- 5) After the password is entered correctly, the analyzer will prompt the user for the new password.
- 6) The password is 4 buttons pressed in sequence. Press any 4 buttons (except for the on and off buttons) to be used as the new password.
- 7) The analyzer will prompt the user to confirm the new password.
- 8) If the password is entered incorrectly, the analyzer will display an error message "Incorrect check password" and return the user to the setup menu.
- 9) If the new password is confirmed, the analyzer will return to the setup menu, and the new password will be saved.

To return to the main programming menu, press either the left arrow [ ] or escape [ESC] button.

### 5.2.6 Recall

Recall is the section of the menu to return the analyzer to the factory default settings.

To restore factory default settings:

- 1) Use the up [ ] and down [ ] arrow buttons to highlight **RECALL** and press the enter [ENTER] button. This brings up the recall setting box.
- 2) The analyzer will prompt the user to set the settings back to the factory standard.
- 3) Use the left [ ] and right [ ] arrow buttons to choose either yes or no, and press enter.
- 4) If **YES** was selected, the user will be returned to the setup menu, and all settings will be returned to the factory default settings.
- 5) If **NO** was selected, the user will be returned to the setup menu without changes.

Note: The password will not be changed back to the factory default by using recall.

To return to the main programming menu, press either the left arrow [ ] or escape [ESC] button.

### 5.3 Display menu

The display menu consists of three menu options, which allow the user to customize the display screens accessed while using the analyzer as a hand-held power quality meter. Each menu is discussed separately in this section.

To access the display menu, use the up [ ] and down [ ] arrow buttons to move the cursor through the available parameters of the programming menu, select **DISPLAY** and press the enter [**ENTER**] button.

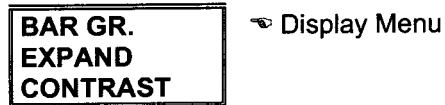

To enter a menu, use the up [ ] and down [ ] arrow buttons to move through the available parameters and press the enter [**ENTER**] button.

To return to the main programming menu, press either the left arrow [ ] or escape [**ESC**] button.

#### 5.3.1 Bar gr.

Bar gr. is the section of the menu to adjust the bar graph screen. This screen gives a graphic representation of a single parameter on all three-phases simultaneously. These are instantaneous measurements and will change in real-time as the system changes.

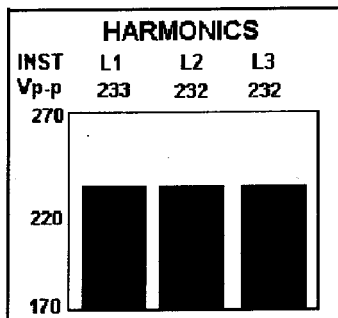

To change the parameter and the bar graph scale:

- 1) Use the up [ ] and down [ ] arrow buttons to highlight **BAR GR.** and press the enter [**ENTER**] button. This brings up the bar graph parameter selection box with the existing selection highlighted.
- 2) Use the up [ ] and down [ ] arrow buttons to move through the available parameters.
- 3) After the parameter has been selected, press the enter [**ENTER**] button. This brings up the zero-scale selection box. The existing zero-scale selection will be highlighted.
- 4) In the lower right-hand corner of the screen is a numerical keypad. Use the up [ ], down [ ], left [ ], and right [ ] arrow buttons to move the cursor through the keypad.
- 5) Press the set [**SET**] button to select a new numerical value. You can change the zero-scale to a negative number by selecting the  $\pm$  symbol. A decimal point may also be used in the zero-scale by selecting the decimal point [.]
- 6) To delete a number, select the backspace icon [←] and press the set button.
- 7) After the zero-scale value has been selected, press the enter [**ENTER**] button. This brings up the full-scale selection box. The existing full-scale selection will be highlighted.
- 8) Press the set [**SET**] button to select a new numerical value. You can change the full-scale to a negative number by selecting the  $\pm$  symbol. A decimal point may also be used in the full-scale by selecting the decimal point [.]

- 9) After the full-scale value has been selected, press the enter **[ENTER]** button. This will return the user to the bar graph screen and the new scaling will be applied to the graph. If the full-scale value entered is lower than the zero-scale value, the analyzer will display the "ZERO must be lower than FULL SCALE" error message at the bottom of the screen. This message will disappear after a few seconds and return the user to the zero-scale selection.
- 10) Press the enter **[ENTER]** button to save your changes and return to the display menu.

Note: This screen can also be changed directly from the display while the analyzer is being used as a hand-held power quality meter. (See section 4.3 for more information)

To return to the main programming menu, press either the left arrow [ ] or escape **[ESC]** button.

### 5.3.2 Expand

Expand is the section of the menu to adjust the exploded view screen. In this screen, any three parameters can be selected and displayed in large characters for easy viewing. These are instantaneous measurements and will change in real-time as the system changes.

Note: Any three parameters can be selected regardless of the measurement type, or parameters chosen for data recording.

INST	HARMONICS
Vp-n L1	<b>220</b>
Vp-n L2	<b>221</b>
Vp-n L3	<b>224</b>

To change these parameters:

- 1) Use the up [ ] and down [ ] arrow buttons to highlight **EXPAND** and press the enter [ENTER] button. This brings up a grid showing all of the available parameters.
- 2) The selected parameters will be highlighted in black.
- 3) Use the up [ ], down [ ], left [ ], and right [ ] arrow buttons to move the cursor through the parameters.
- 4) Pressing the set [SET] button selects, or de-selects a parameter. Pressing set while on "CLEAR ALL " at the bottom of the display clears all parameters.
- 5) Only three parameters may be chosen. If an additional parameter is accidentally selected, the analyzer will display the "OUT OF RANGE" error message at the bottom of the screen. This message will disappear after a few seconds.
- 6) After all three parameters have been selected, press the enter [ENTER] button to accept the new parameters. This will return the user to the exploded view screen and the new parameters will be displayed on the screen.
- 7) Pressing the escape [ESC] button will return the user to the display menu without modifying the parameters.
- 8) Press the enter [ENTER] button to save your changes and return to the display menu.

Note: This screen can also be changed directly from the display while the analyzer is being used as a hand-held power quality meter. (See section 4.2 for more information)

To return to the main programming menu, press either the left arrow [ ] or escape [ESC] button.

### 5.3.3 Contrast

Contrast is the section of the menu to adjust the screen contrast. This adjustment helps the user view the display in direct sunlight or dark conditions.

To adjust the contrast:

- 1) Use the up [ ] and down [ ] arrow buttons to highlight **CONTRAST** and press the enter [ENTER] button. This brings up the contrast adjustment box.



- 2) Use the left [ ] and right [ ] arrow buttons to increase or decrease the display contrast. The contrast will change while you are making the adjustment.
- 3) Pressing the escape [ESC] button will return the user to the display menu without modifying the parameters.
- 4) Press the enter [ENTER] button to save your changes and return to the display menu.

Note: The contrast can also be adjusted directly from the display screen. See section 2.2 of this instruction manual for more information.

To return to the main programming menu, press either the left arrow [ ] or escape [ESC] button.

## 5.4 Run menu

From the run menu, the user can start or stop data collection. The status of data collection is shown in the on the display screen. If data is being collected, **RECORD** will be displayed at the bottom of the screen. If data collection has been stopped, **STOP** will be displayed in the lower left-hand corner of the screen. These messages will be displayed on all display screens except for the setup screen.

To change the data collection status:

- 1) Use the up [ ] and down [ ] arrow buttons to move the cursor through the available parameters of the programming menu, select **RUN** and press the enter [ENTER] button.
- 2) Use the up [ ] and down [ ] arrow buttons to toggle between **RUN** and **STOP**. Selecting run will begin/resume data collection and selecting stop will halt data collection.
- 3) Pressing the escape [ESC] button will return the user to the main programming menu without modifying the parameters.
- 4) Press the enter [ENTER] button to save your changes and return to the main programming menu.

## 5.5 Files menu

The files menu consists of three menu options to view all of the files in the directory, delete old files, and format the memory. Each menu is discussed separately in this section.

To access the files menu, use the up [ ] and down [ ] arrow buttons to move the cursor through the available parameters of the programming menu, select **FILES** and press the enter [ENTER] button.

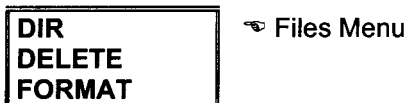

To enter a menu, use the up [ ] and down [ ] arrow buttons to move through the available parameters and press the enter [ENTER] button.

To return to the main programming menu, press either the left arrow [ ] or escape [ESC] button.

### 5.5.1 DIR

Directory is the section of the menu to access the listing of files that are stored in the analyzer's internal memory.

To view the directory:

- 1) Use the up [^] and down [v] arrow buttons to highlight **DIR** and press the enter [ENTER] button. The analyzer will bring up the directory.

File name with extension	Start date	Recording time (hh:mm)	File length (Bytes)
STD-PROG.STD	12/02/02	14:07	184
MACHINE1.STD	12/15/02	23:54	108117

Available memory — Bytes Free: 925512

- 2) The directory displays the file name, file extension, file size, date that the file was started, and the length of time for each file listed in the directory.
- 3) The available memory will also be listed at the bottom of the screen.
- 4) Pressing the escape [**ESC**] button will return the user to the files menu.

### 5.5.2 Delete

Delete is the section of the menu to delete specific files that are stored in the analyzer's internal memory.

To delete a file:

- 1) Use the up [**^**] and down [**v**] arrow buttons to highlight **DELETE** and press the enter [**ENTER**] button. The analyzer will bring up the directory.

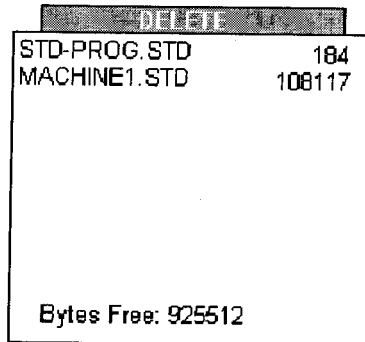

- 2) The directory displays the file name, file extension, and file size for each file listed in the directory.
- 3) The available memory will also be listed at the bottom of the screen.
- 4) Use the up [ ] and down [ ] arrow buttons to move the cursor through the available files and press the enter [**ENTER**] button.
- 5) The analyzer will ask for a confirmation before deleting the file.
- 6) Use the left [ ] and right [ ] arrow buttons to toggle between **YES** and **NO** and press enter.
- 7) Choosing no will return the analyzer to the directory to select a file for deletion.
- 8) Choosing yes will remove the file from the analyzer's memory and return the analyzer to the directory to select another file for deletion.
- 9) Pressing the escape [**ESC**] button will return the user to the files menu.

### 5.5.3 Format

Format is the section of the menu to completely format the analyzers menu. It will erase all files and eliminate any memory errors that may exist.

To format the memory:

- 1) Use the up [↑] and down [▼] arrow buttons to highlight **FORMAT** and press the enter [ENTER] button. The analyzer will ask for a confirmation before proceeding.
- 2) Use the left [←] and right [→] arrow buttons to toggle between **YES** and **NO** and press enter.
- 3) Choosing no will return the analyzer to the file menu without formatting the memory.
- 4) Choosing yes will format the memory and return the analyzer to the file menu.

### 5.6 Clear menu

The clear menu consists of 2 menu options to reset the energy counters and maximum and minimum values saved on the display of the analyzer. Clearing these values will only affect the displayed measurements. It will not affect data collected by the analyzer.

To access the clear menu, use the up [↑] and down [▼] arrow buttons to move the cursor through the available parameters of the programming menu, select **CLEAR** and press the enter [ENTER] button.



To enter a menu, use the up [↑] and down [▼] arrow buttons to move through the available parameters and press the enter [ENTER] button.

#### 5.6.1 Energy

Energy is the section of the menu to clear the energy values in the main display screen. These values will begin at zero, and start to accumulate when the analyzer is returned to the display screen.

INST	L1	L2	L3	MI
Vp-n	235	233	237	235
A	31.26	30.99	30.70	30.98
KW	7.376	7.247	7.299	21.92
Kvar-L	0.729	0.667	0.768	2.164
Kvar-C	0	0	0	0
P.F.	1.00	1.00	1.00	1.00
Hz	50.0			
kVA				21.92
An				7.2
kwh		450.158		
kvarhL		82.640		
kvarhC		0.029		
05/11/98 17:19:04				

Energy values

To clear the energy values:

- 1) Use the up [↑] and down [▼] arrow buttons to highlight **ENERGY** and press the enter [ENTER] button. The analyzer will ask for a confirmation before proceeding.
- 2) Use the left [←] and right [→] arrow buttons to toggle between **YES** and **NO** and press enter.
- 3) Choosing no will return the analyzer to the clear menu without clearing the energy values.
- 4) Choosing yes will clear the energy values and return the analyzer to the clear menu.

## 5.6.2 Max/min

Max/min is the section of the menu to clear the maximum and minimum values in the main display screen. These values will begin at when the analyzer is returned to the display screen.

To clear the maximum and minimum values:

- 1) Use the up [ ] and down [ ] arrow buttons to highlight **MAX/MIN** and press the enter [ENTER] button. The analyzer will ask for a confirmation before proceeding.
- 2) Use the left [ ] and right [ ] arrow buttons to toggle between **YES** and **NO** and press enter.
- 3) Choosing no will return the analyzer to the clear menu without clearing the max and min values.
- 4) Choosing yes will clear the max and min values and return the analyzer to the clear menu.

## 5.7 Off menu

From the off menu, the user can enable the password to protect the power analyzer from accidental shut off. By activating the turn-off password protection, the user will be prompted for a password before the analyzer can be shut down.

To change the password protection status:

- 1) Use the up [ ] and down [ ] arrow buttons to move the cursor through the available parameters of the programming menu, select **OFF** and press the enter [ENTER] button.
- 2) The analyzer will prompt the user to activate the password protection
- 3) Use the left [ ] and right [ ] arrow buttons to toggle between **YES** and **NO** and press enter.
- 5) Choosing no will deactivate the turn-off password protection and return the unit to the main programming menu.
- 6) Choosing yes will activate the turn-off password protection and return the unit to the main programming menu.

## 6. Hooking up the analyzer

Before hooking up the 800 series power analyzer, please observe the following:

- The unit has sufficient battery life for the duration of the test, or is connected to line power.
- Supply voltage is connected to a properly grounded outlet.
- Maximum input voltage does not exceed analyzer ratings:
  - 500VAC phase to neutral
  - 866VAC phase-phase
- Clamp adapter range sufficient for the measurement circuit
  - Does not exceed maximum current rating of adapter
  - Does not fall below 10% of current rating of adapter
- Voltage leads being used were supplied with the instrument. Replacement leads are available from IDEAL INDUSTRIES
- Power analyzer has been setup for the electrical system under test

To make a measurement with the power analyzer:

- 1) Connect the power supply to the power analyzer and to a properly grounded outlet using the factory supplied cables. (Section 3.3)
- 2) Insert the voltage leads into the analyzer, and match the color-coded current transformers with the leads to help simplify the connection process. Insert the current transformer leads into the proper input connectors on the Model 806. (Section 2.2)
- 3) Connect the voltage leads and current clamp adapters to the electrical system as shown in the following sections. (Sections 6.1.1 – 6.1.5)
- 4) Turn the instrument on and select the harmonics program. (Section 3.1)
- 5) Verify that the voltage and current ratios are correct on the setup screen (Section 4.5)
- 6) Begin taking measurements

### 6.1.1 3-phase 4-wire connection diagram

Three-Phase Four-Wire Connection

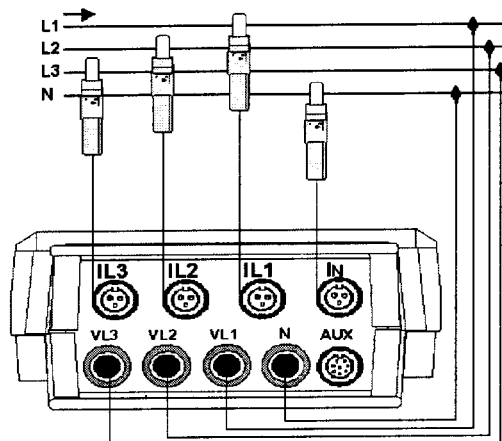

### 6.1.2 3-phase 3-wire connection diagram

Three-Phase Three-Wire Connection

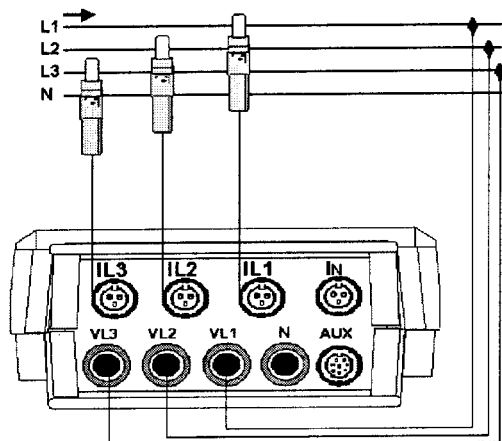

### 6.1.3 Single-phase connection diagram

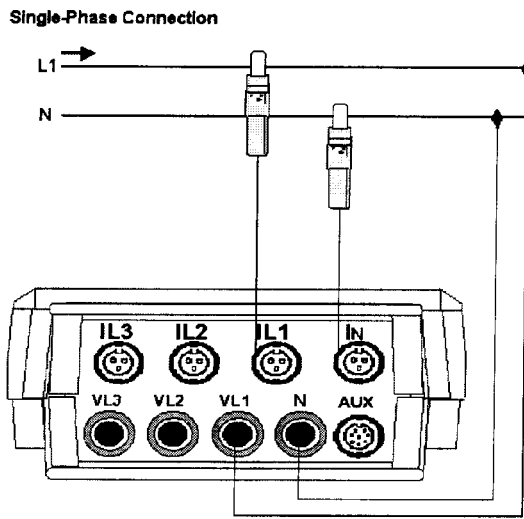

### 6.1.4 Split-phase connection diagram

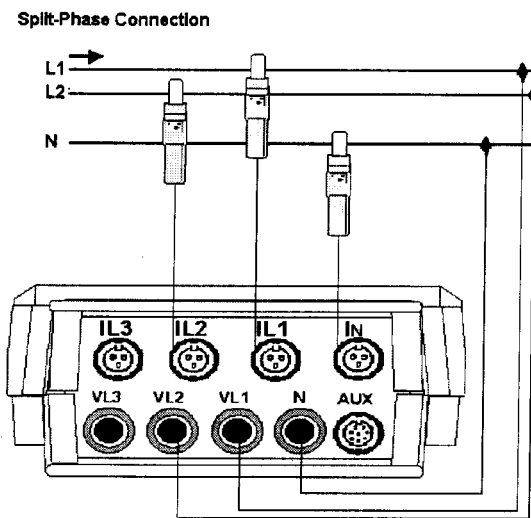

### 6.1.5 2 wattmeter method (3 PT, 2 CT) connection diagram

Two Wattmeter Method (3 PT, 2 CT)

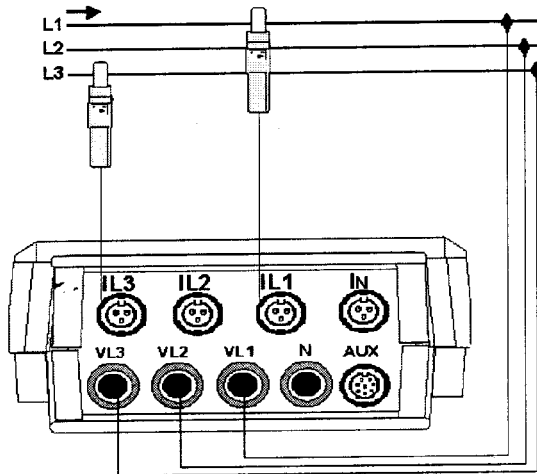

## 7. Recording data

The power analyzer has been pre-configured at the factory to begin recording data immediately. Simply change the analyzer to run mode (Section 5.4) and begin collecting data using the factory default settings. If you are unsure as to what these factory settings are, refer to the quick reference guide, located in section 12 of this instruction manual. It contains a complete listing of all programming parameters and the factory default settings.

If you are using the power analyzer for the first time, we recommend that you follow the following procedure for creating a new file for recording data:

- 1) Turn the instrument on and select the harmonics program. (Section 3.1)
- 2) Verify that the measurement type and voltage and current ratios are correct on the setup screen. (Section 4.5)
- 3) If not correct, change these parameters in the measure menu. (Section 5.2.1)
- 4) Select the desired recording period for the analysis that you are conducting. (Section 5.2.2)
- 5) Create a file name and select the appropriate file type. (Section 5.2.2)
- 6) Choose the desired measurement parameters for the analysis that you are conducting. (Section 5.2.2)

Check the setup screen after programming the analyzer to verify that the available recording time is sufficient for your needs. (Section 4.5) If the time is not sufficient, you can setup trigger points to customize your data collection, capturing only the data that falls outside normal operating parameters. (Section 5.2.2)

## 8. Downloading data to your computer

After the power analyzer has successfully recorded the data, then the data needs to be transferred to a computer for analysis. This process is primarily controlled by the PowerVision™ analysis software.

To download data to the PowerVision™ software:

- 1) Plug the power cord into the power supply/RS-232 interface.
- 2) Connect the analyzer to the power supply/RS-232 interface with the interface cable.
- 3) Connect the power supply/RS-232 interface to the serial input on your computer with the RS-232 cable
- 4) Turn the analyzer on.
- 5) Verify that the analyzer is not recording data.
- 6) Verify that the analyzer is not in the programming menu.
- 7) Launch the PowerVision software. If this has not been loaded onto your computer, place the enclosed PowerVision CD into your CD ROM drive. It will automatically launch the interactive demo and give the user the option to load the PowerVision software.
- 8) Go into the drop-down files menu and select portable devices, or press the icon to search for a connected device.

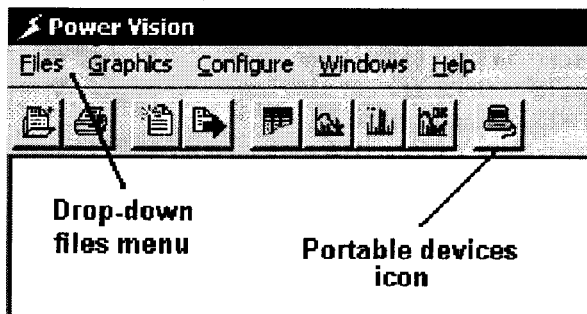

- 9) The software will activate the auto-detect feature and begin scanning all communication ports at all baud rate speeds to find the power analyzer.
- 10) If no devices are detected, the software will give an error message. Re-connect the analyzer and step through this process again.
- 11) Once the connection has been made, the software will display the directory of files in the analyzer's memory.

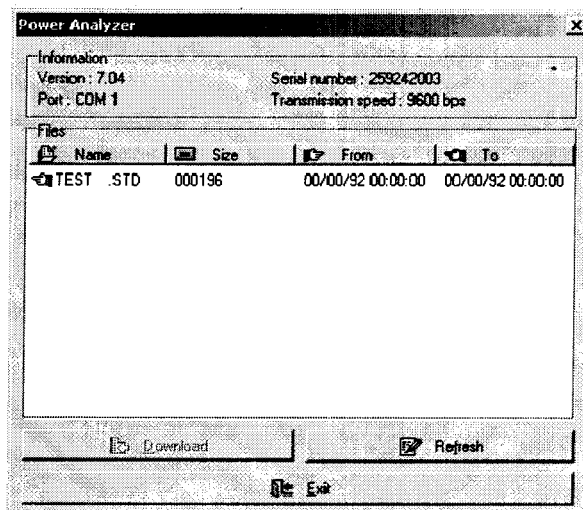

- 12) Using the mouse, select a file to be downloaded and left-click on the download button.
- 13) The software will bring up the file box, giving the user the opportunity to change the file name or choose the file location.

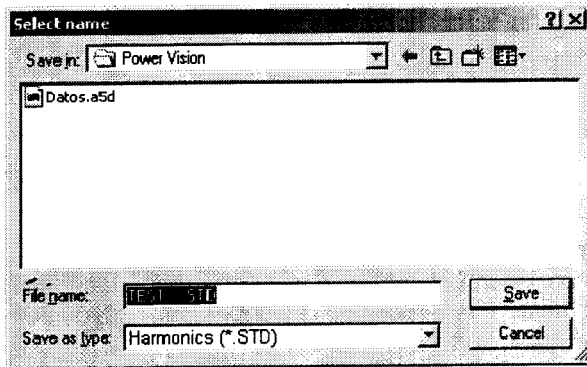

- 14) To save the file without any changes, left-click on the save button.
- 15) To change the name, highlight the file name and type in a new file name.
- 16) To change the file location, left-click on the down arrow next to the save in: selection box. This brings up a drop-down menu with the entire file directory of your computer.
- 17) Double-left-click on the appropriate file location and left-click on the save button.
- 18) The software will then download the directory to your computer. This may take a few minutes, depending on the size of the file.

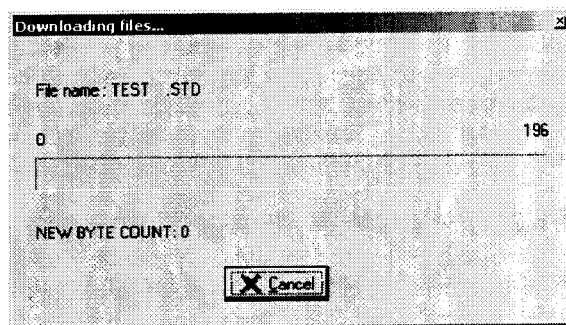

- 19) Repeat this process until all available files have been downloaded onto the computer.

If problems exist during the download process, check the following:

- 1) The cables used to connect the power supply/RS-232 interface to the analyzer and computer are the cables supplied with the power analyzer.
- 2) The power supply/RS-232 interface has been connected to a properly grounded receptacle.
- 3) No other devices are on the comm. Port.
- 4) If the device is a laptop computer, check that the infrared port has been disabled.
- 5) The analyzer is not in run mode.
- 6) The file directory of the analyzer has programs to download.
- 7) The analyzer is not in the programming menu. You must be in the display screens to download data.

If problems persist, please contact our Technical Hotline at 877-201-9005 for assistance.

## 9. PowerVision™ software and interactive demo

A CD with the PowerVision™ Analysis Software and Interactive Demo has been included with the power analyzer. This disk has an interactive demo to help the user get more familiar with the power analyzer and PowerVision software.

The demo has an auto-run feature that will launch the interactive program immediately after it has been inserted into the CD ROM drive. The program has four sections; an introductory section discussing the features and benefits of the power analyzer, a display section that goes through the various display screens and using the power analyzer as a portable hand-held analyzer, a programming section that walks through some of the basic programming setup, and a software section that demonstrates the capabilities of the PowerVision software.

The PowerVision software can be downloaded directly from this demo. It is complete with sample data, allowing the user to try out the software and get a better understanding of what they can do with the data before they take actual measurements.

## 10. Technical specifications

Supply voltage:	80-265VAC
Frequency:	50-60 Hz
Burden:	8 VA
Operation temperature:	0 to 50 °C
Measuring circuit:	3Φ 3-wire, 3Φ 4-wire, 3PT-2CT, 1Φ, 1Φ Split
Safety:	Category III - 600 V, as per EN 61010
Internal memory:	1 MB
RS-232 output:	Serial type output
Baud rate:	1200, 2400, 4800, 9600, 19200, 38400 (user selectable)

### Voltage measurement:

Measuring range:	20-500 VAC (phase-neutral) 20-866 VAC (phases-phase)
Frequency:	45-65 Hz

### Current measurement:

Phase current range:	15-1000AAC*
Neutral current range:	1.5-100AAC**

### Accuracy:

Voltage .....	0.5 % of readout ± 2 digits
Current .....	0.5 % of readout ± 2 digits
Active power .....	1.0 % of readout ± 2 digits
Reactive power.....	1.0 % of readout ± 2 digits

### Measuring conditions to assure accuracy:

- Temperature range between 5 °C and 45 °C
- Power factor between 0.5 and 1
- Measuring range between 5 % and 100 %

\* Based on supplied clamp adapter. Other clamp adapters available (Section 11)

\*\* Catalog #61-807 supplied with 100AAC clamp adapter. Other clamp adapters available (Section 11)

**Mechanical Specifications:**

Display: 160 x 160 pixel backlit display  
Case dimensions: 220 x 60 x 130 mm  
Weight: 0.8 kg.

**Relevant Standards:**

EN 60664, EN 610110, EN 61036, VDE 110, UL 94

**EM EMISSION.**

- EN 61000-3-2 (1995), Harmonics.
- EN 61000-3-3 (1995), Fluctuations in voltage
- EN 50081-2 (1993), Industrial emission:
- EN 55011 (1994): Conducted (EN 55022 - Class B).
- EN 55011 (1994): Radiated (EN 55022 - Class A).

**EM IMMUNITY.**

- EN 50082-2 (1995), Industrial immunity.
- EN 61000-4-2 (1995), ESD.
- ENV 50140 (1993), EM Radiated field of RF.
- EN 61000-4-4 (1995), EFT burst.
- ENV 50141 (1993), RF common mode.
- EN 61000-4-8 (1995), 50 Hz H-field.
- EN 50082-1 (1997), Residential Immunity.
- EN 61000-4-5 (1995), Surges.
- EN 61000-4-11 (1994), Dips, Interruptions.

**11. Optional programs and accessories**

Expand the capabilities of your 800 series analyzers with one of the optional programs:

**#61-815 Disturbances Program**

- Tracks sags, swells and transients
- Programmable trigger points
- Captures individual waveforms for analysis

**#61-816 Check-Meter Program**

- Monitors performance of in-line energy meters
- Stores data and provides comparison against mechanical or electrical meters
- Monitors key power and energy measurements

**#61-817 Fast-Check Program**

- Captures transient waveforms
- Monitors key power and energy measurements

Additional power clamp adapters are available to extend the current capabilities of your 800 series power analyzer:



**#61-810      200/2000AAC Power Clamp Adapter**

- Selectable 200/2000AAC measurements
- Set of 3



**#61-814      5AAC Power Clamp Adapter**

- 5AAC measurements
- Set of 1



**#61-811      1000AAC Power Clamp Adapter**

- 1000AAC measurements
- Set of 3



**#61-330      1000AAC Flexible Clamp Adapter**

- 1000AAC measurements
- Use with #61-466 power analyzer adapter
- 24" (61cm) sensor length
- Set of 1



**#61-812      500AAC Power Clamp Adapter**

- 500AAC measurements
- Set of 3



**#61-330      300/3000AAC Flexible Clamp Adapter**

- Selectable 300/3000AAC measurements
- Use with #61-466 power analyzer adapter
- 36" (91cm) sensor length
- Set of 1



**#61-813      100AAC Power Clamp Adapter**

- 100AAC measurements
- Set of 1

Replacement test leads, carrying cases and power supplies are also available.

**#TL-805      Power Analyzer Test Lead Set**

- Test leads with alligator clips
- Set of 4

**#C-1000      Carrying Case**

- Case holds analyzer, 1000AAC clamp adapters, power supply, test leads and all cables.

**#PS-352      RS-232 Interface/Power Supply**

- Includes power supply/RS-232 interface, power cord, RS-232 communication cable, analyzer communication cable

**#C-2000      Carrying Case**

- Case holds analyzer, 200/2000AAC clamp adapters, power supply, test leads and all cables.

## 12. Quick Reference Guide

Setup Menu	Submenu selections	Description	Options	Default Setting
Measure		This menu is for setting up the voltage and current measurement options		
	Wiring	The circuit type being measured	3Φ 3-wire, 3Φ 4-wire, 3PT-2CT, 1Φ, 1Φ Split	3Φ 4-wire
	PT/CT	The ratios for PT & CT transformers		
	Prim V	The primary value of the voltage ratio	Numerical value	1V
	Sec V	The secondary value of the voltage ratio	Numerical value	1V
	Prim I	The primary value of the current clamps	Numerical value	1000A
	Prim I <sub>N</sub>	The primary value of the neutral current clamp	Numerical value	100A
Record		This menu is for setting up the recording parameters		
	Period	The recording period for data collection	hh:mm:ss (1s to 4h)	15 minutes
	Trigger	Measurement value or time values that will trigger data collection to begin		
	Level	Setting the maximum and minimum thresholds for the trigger	Measurement parameter and numerical value	Auto
	Time	Setting the on/off date and time thresholds for the trigger	mm/dd/yy, hh:mm:ss	00/00/00, 00:00:00
	Name	Name and file type for the record		
	Name	File name	Alpha/numeric value	STD-PROG
	Type	File type	Cyclical, linear	Cyclical
	Param	Select the parameters that will be recoded during data collection		
	Inst	Select the instantaneous values to be recorded	Vp-p, Vp-n, A, kW, kvarL, kvarC, PF, Hz, kVA, A <sub>N</sub> , kWh, kvarhL, kvarhC	All
	Max	Select the maximum values to be recorded	Vp-p, Vp-n, A, kW, kvarL, kvarC, PF, Hz, kVA, A <sub>N</sub>	All
	Min	Select the minimum values to be recorded	Vp-p, Vp-n, A, kW, kvarL, kvarC, PF, Hz, kVA, A <sub>N</sub>	All
	Harm	Select the level of harmonics to be recorded	V, A to 30 <sup>th</sup> or 50 <sup>th</sup>	All to 50 <sup>th</sup>
Comm		Select the communication protocol for downloading data	Baud rate, parity, length, stop bits	9600, No, 8, 1
Clock		Set date and time information		
	Date	Select either European or American date format	mm/dd/yy or dd/mm/yy	mm/dd/yy
	Date/time	Change date and/or time	mm/dd/yy, hh:mm:ss	
Password		Change password	Old password, new password, confirm new	[ ], [SET], [ ], [SET]
Recall		Return 806 to factory settings	Yes, no	

Display Menu		Description	Options	Default Setting
Bar gr.		Set the parameters for the bar graph screen		
	Bar Gr.	Select the measurement for the graph	Vp-p, Vp-n, A, kW, kvarL, kvarC, PF	Vp-n
	Zero	Set the zero-scale value of the bar graph	Numerical value	0
	Full scale	Set the full-scale value of the bar graph	Numerical value	300
Expand		Select three parameters for the exploded view screen	Vp-p, Vp-n, A, kW, kvarL, kvarC, PF, Hz, kVA, A <sub>N</sub> , kWh, kvarhL, kvarhC	Vp-n (L1), Vp-n (L2), Vp-n (L3)
Contrast		Adjust the display contrast	Decrease/increase contrast	

Run Menu	Description	Options	Default Setting
Run/stop	Start/stop data collection	Run/stop	Stop

Files Menu	Description	Options	Default Setting
Dir	Display the file directory of the power analyzer's memory		
Delete	Delete a file from the analyzer's memory		
Format	Format the power analyzer's memory		

Clear Menu	Description	Options	Default Setting
Energy	Clear all energy counters on the display		
Max/min	Clear all min/max values on the display		

Off Menu	Description	Options	Default Setting
Password	Set the password protection on power off	On/off	On

### **13. Warranty and repair information**

This meter is warranted to the original purchaser against defects in material or workmanship for the lifetime of the meter. During this warranty period, IDEAL INDUSTRIES, INC. will, at its option, replace or repair the defective unit, subject to verification of the defect or malfunction.

This warranty does not apply to defects resulting from abuse, neglect, accident, unauthorized repair, alteration, or unreasonable use of the instrument.

Any implied warranties arising out of the sale of an IDEAL product, including but not limited to implied warranties of merchantability and fitness for a particular purpose, are limited to the above. The manufacturer shall not be liable for loss of use of the instrument or other incidental or consequential damages, expenses, or economic loss, or for any claim or claims for such damage, expenses or economic loss.

State laws vary, so the above limitations or exclusions may not apply to you. This warranty gives you specific legal rights, and you may also have other rights, which vary from state to state.

For units in need of repair or warranty repair, please call our Technical Hotline – Toll Free 877-201-9005.

(C.D. - 800 Series Power Vision Software)



800 Series Power Analyzer  
PowerVision™ Instruction Manual

Machine Type # 061000

Power Analyzer Ideal

807 clw clamp & Adaptor



This software manual comes with  
the C.D.