

Warranty Registration Card
 Cartolina di Registrazione Garanzia
 Fiche enregistrement garantie
 Garantie - Registrierung Karten



SCOTSMAN®

ICE SYSTEMS

Owner Name
 Nome del Cliente
 Nom du Client
 Name des Kunden

Selling Agent
 Agente Venditore
 Agent Vendeur
 Verkäufer

Street
 Via
 Rue
 Strasse

Street
 Via
 Rue
 Strasse

City
 Città
 Ville
 Stadt

City
 Città
 Ville
 Stadt

Date of installation
 Data d'installazione
 Date d'installation
 Aufstellungsdatum

Month
 Mese
 Mois
 Monat

Year
 Anno
 An
 Jahr

Model Number
 Modello Numero
 Modèle numéro
 Modell Nr.

Serial N.
 Numero di serie
 Série numéro
 Seriennummer

Note:
 Please return this card to factory for warranty protection.
 Ritornare la vostra macchina ritornando subito questo tagliando alla fabbrica.
 Retournez cette carte à l'Usine pour la protection de votre machine.
 Bitte schicken diese Karte an die Fabrik zurück, um Ihre Maschine zu schützen.

Warranty Registration Card
 Cartolina di Registrazione Garanzia
 Fiche enregistrement garantie
 Garantie - Registrierung Karten



SCOTSMAN®

ICE SYSTEMS

Owner Name
 Nome del Cliente
 Nom du Client
 Name des Kunden

Selling Agent
 Agente Venditore
 Agent Vendeur
 Verkäufer

Street
 Via
 Rue
 Strasse

Street
 Via
 Rue
 Strasse

City
 Città
 Ville
 Stadt

City
 Città
 Ville
 Stadt

Date of installation
 Data d'installazione
 Date d'installation
 Aufstellungsdatum

Month
 Mese
 Mois
 Monat

Year
 Anno
 An
 Jahr

Model Number
 Modello Numero
 Modèle numéro
 Modell Nr.

Serial N.
 Numero di serie
 Série numéro
 Seriennummer

Note:
 Please keep this card for warranty protection of your system.
 Conservare questa cartolina per la protezione della vostra macchina.
 Conservez cette carte pour la protection de votre machine.



ICE SYSTEMS

Fleet type # 06291
 Ice maker 138 kg.

Manual #
 316

ISTRUZIONI D'USO
 HOW TO USE IT
 NOTICE D'EMPLOI
 GEBRAUCHSANWEISUNG
 GEBRUIKSAANWIJZING
 INSTRUCCIONES PARA EL USO
 MANUAL DE USO
 BRUKSANVISNING
 BRUKSANVISNING
 BRUGSANVISNING
 KÄTTÖHJE
 ΟΔΗΓΙΕΣ ΧΡΗΣΕΩΣ

MV 300

MV 450

MV 600

MV 800

MV 1000



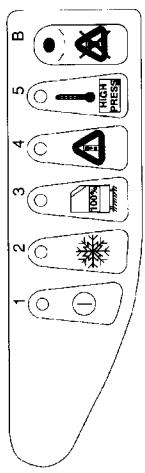
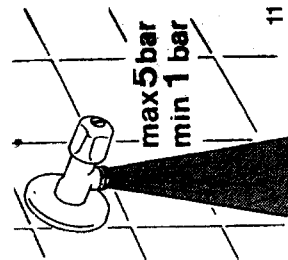
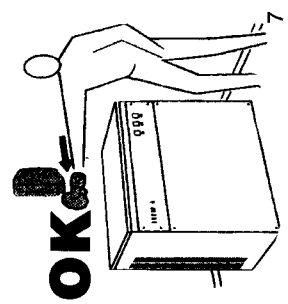
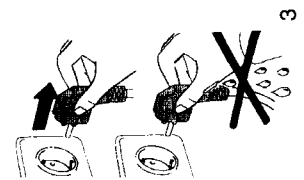
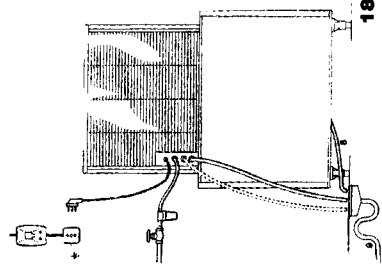
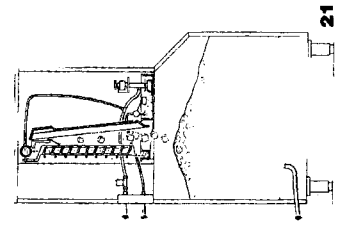
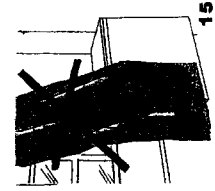
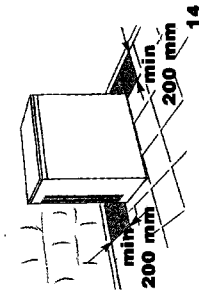
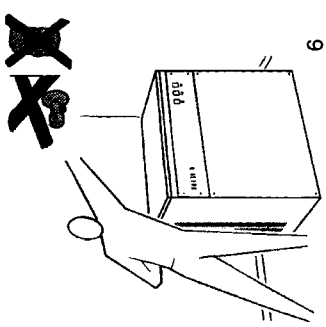
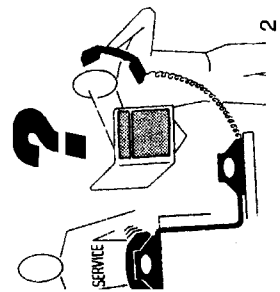
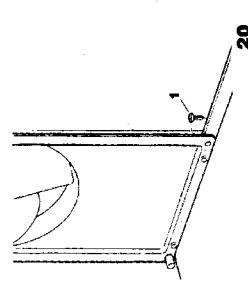
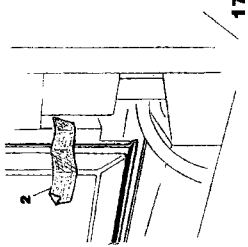
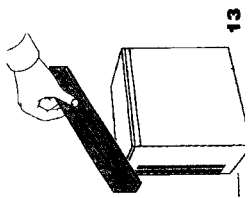
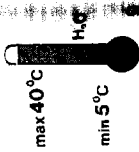
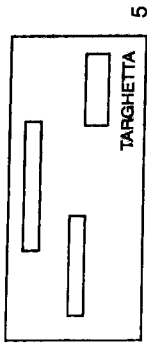
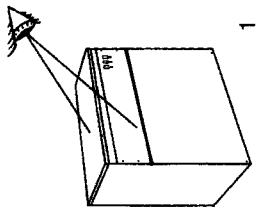

- LED N° 1 * Electrical power supply.
- LED N° 2 Rete.
- Funzionamento.
- LED N° 3 Deposito pieno/lavaggio.
- LED N° 4 Allarme.
- LED N° 5 Allarme alta pressione.
- PULSANTE B ROSSO** Pulsante Reset/Lavaggio.

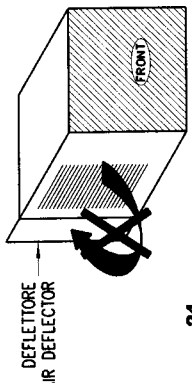
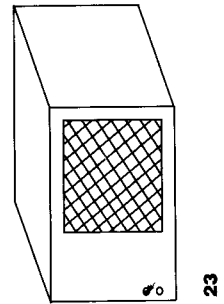
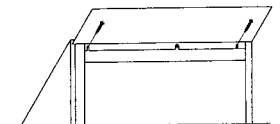
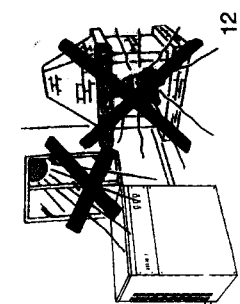
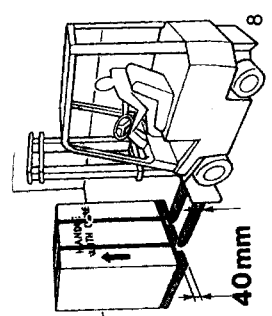
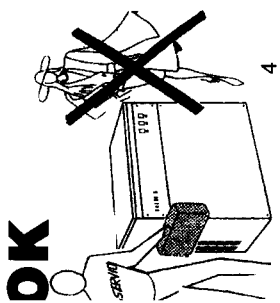
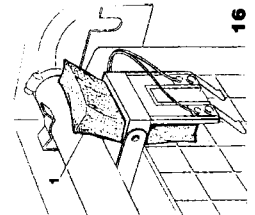
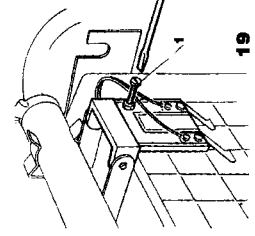



WARNING!!

IT IS EXPRESSLY FORBIDDEN FOR THE USERS OF THE EQUIPMENT TO CARRY OUT THE FOLLOWING OPERATION OR THOSE MARKED BY THE SYMBOL. SUCH OPERATIONS MUST BE PERFORMED EXCLUSIVE BY QUALIFIED PERSONNEL.

1. ELECTRICAL CONNECTIONS
2. WATER MAINS CONNECTIONS
3. MACHINE INSTALLATION
4. MACHINE TEST RUN
5. REPAIRING MACHINE COMPONENTS AND PARTS
6. DISASSEMBLY OF MACHINE AND/OR COMPONENTS
7. ADJUSTMENT AND SETTING PROCEDURES
8. MACHINE CLEANING AND MAINTENANCE RELATIVE TO THE FOLLOWING PARTS AND COMPONENTS:
 - ELECTRICAL,
 - ELECTRONIC,
 - MECHANICAL,
 - COOLING SYSTEM.

GB MODELS 120 Kg, 200 Kg, 300 Kg, 400 Kg, 500 Kg.

GENERAL SPECIFICATIONS

The ice-making machines are approved by VDE, GS and the relative symbols are put on the packing, serial plate and body of the machine (pict. nr. 10).

CE

OUR PRODUCTS ARE GOVERNED BY EC LOW TENSION DIRECTIVE 73/23/CEE - EMC - 89/336/CEE AND THE COVER OF THE MANUAL IS MARKED ACCORDINGLY.

INSTALLATION

Before bringing the ice-maker into action perform the following operations:

- 1) Check that ice maker has not been damaged during transport (pict. nr. 1)
- 2) Match the producer to its storage bin, fixing them with the 20 screws supplied with the machine (pict. nr. 20).
- 3) Clean the inside of machine by means of a warm water and sodium-bicarbonate dampened sponge; rinse with plain water and dry accurately.
- 4) Locate the producer and the storage bin in the final place, making sure that the two are perfectly sport-leveled, in order to obtain an even distribution of the water all over the evaporator and a regular falling of the cube plate (pict. nr. 13).
- 5) The storage bin is equipped with height adjustable feet, which allow for an easy levelling and comfortable future cleaning of the floor.
- 6) Unlock the sensor and the baffle by removing the locks 1 and 2, which have been applied to avoid and damage during the transport (pict. nr. 16 and 17). For the model 500 kg. unlock the sensors and the deflector by removing the locks 1 and 2, which have been applied to avoid and damage during the transport (pict. nr. 16 and 17).
- 7) The producer has been arranged for the coupling with another producer, which can be installed on the top of the first one. For this installation, a kit can be supplied upon request. It contains all the necessary assembling instructions.
- 8) Do not put the machine in dusty place because this could cause a fast obstruction of the condenser (only for aircooled models).
- 9) Never keep food, bottles or other things in the bin in order to avoid that the ice takes bad smells and tastes.

NOTE:

- Before installing the machine make sure that:
- a) the room temperature must not fall below 10°C (50°F) or above 100°F.
 - b) the water conductivity value must be not below than 10 µs/cm.
 - c) the main water temperature must not fall below 5°C (40°F) or above 35°C (95°F).
 - d) the main water pressure must not fall below 1 atm. (14 PSI) or above 5 atms. (70 PSI). If pressure is above 5 atms. a presasure regulator should be fitted on the water supply machine (pict. nr. 11).
 - e) machine is awais from sources of heat and in a sufficiently ventilated area. A distance of at least 20 cm must be foreseen between the sides/the back of the machines and the walls (pict. nr. 12 - nr. 14).
 - f) the machine don't work with demineralized water

- 9) Connect machine to water supply fist and then to electricity supply.
- 10) Connect the 3/4" Feeding pipe (supplied) to the machine and to the cold drinking water supply line. It is advisable to install a shut-off (not supplied) to the water feeding pipe. If the feeding water of impurities, the applications of a filler watersupply system is recommended. If the water is particularly hard, i.e. rich in minerals and their derivatives, the application of a proper water softener is recommended. Thus, anyscaling of thehydraulic circuit of the machine can be avoided (pict. nr. 18).
- 11) Apply the two-duplied fixible pipes to the machine-container discharge connectors. For a perfect water outlet from the machine a minimum incline of 3% of the pipes is advisable. Check also that the pipes are non throttled or siphoned. It is advisable that the pipes discharge in an open vented drain (pict. nr. 18).
- 12) Connect the machine to the electricity supply after having checked that the voltage corresponds to that on the plate on the rear panel of the machine (pict. nr. 5).
- 13) Air deflector installation. (pict. nr. 24) The deflector has to be installed in order to prevent hot air recirculation in the condenser.

The maximum voltage variation should not exceed ± 6% of that stated on the rating plate. Provide for a feeding circuit to the machine, with its own bipolar main switch at least 3 mm. of contacts opening. The machine should be connected to an independent fuse or suitable power supply with earth terminal. The whole system must be calibrated according to the power machine indicated on the registration label.

A DIFFERENTIAL SWITCH MUST BE INCLUDED IN THE ELECTRICAL CIRCUIT.

INFORMATION FOR THE "SERVICE"

THE FOLLOWING OPERATIONS MUST BE CARRIED OUT BY QUALIFIED PERSONNEL

STARTING THE MACHINE

WARNING: Do not let the device run before our technician's invention.

Before starting the ice producer perform the following:

- a) Remove the side.
 - b) Check that the compressor is free to swing on the rubbers on the relative stirrups and that the fans of the electric fan turn freely.
- Moreover:
- 1) Verify that the water supply valve is open; then connect the machine electrical plug to the socket and switch on the main switch; the machine starts working automatically.
 - 2) Check that the sensor prevents the water from getting into the recycle tray, when it is 40-45 mm. from the upper edge.
 - 3) Check if the water pumps works regularly (30" delay).
 - 4) Check that the water flows regularly on the evaporator and that there are no leakages in the water-piping system.
 - 5) Verify any irregular vibrations.
 - 6) To adjust the cube height, action the screw nr. 1 (pict. nr. 19) which determines the distance between the sensor reads and the evaporator. The distance (fixed

- 7) by us) is of about 4 mm for a normal ice cube. Check an ice production cycle ensuring that the cube plate is conveyed into the storage bin and that all operations are performed regularly.
- 8) Verify the working of the machine-stopping microswitch by keeping the splash-guard deflector open for over 30 seconds.
- 9) Put on the panels you have removed before.
- 10) The front panel is equipped with 5 "LEDs" next to the symbols corresponding to the following functions:

LED Nr. 1 LED Nr. 4

Electrical power supply. Alarm.

LED Nr. 2 LED Nr. 5

Operation. Alarm high pressure.

LED Nr. 3 BUTTON B

Tank full/Washing Reset/Washing.

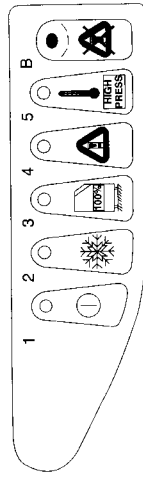

ATTENTION

The machine is equipped with a maximum pressure switch with manual reset.

Red pilot light lit LED 5: alarm due to a raised condensation pressure, the machine stops.

FUNCTIONING:

The ice cubes are produced within a special five-like vertical copper evaporator.

A circulation pump produces a continuous water flow on the front grid; gradually, a portion of the water turns into ice on the inner walls of the small cells, and forms cubes; the height of which is controlled by a special adjustable sensor. Such a sensor is made up of two metal reeds, which are fed by a low-voltage circuit. (Insulated between themselves), and kept at a certain distance (adjustable through a screw) from the evaporator. As the ice is produced, the water film flowing on the ice itself approaches the two reeds finally touches them, thus closing the electronic circuits which causes at the same time:

- The sending of warm gas to the evaporator, by opening a solenoid valve, and the consequent disjunction of the cube plate from the evaporator.
 - The opening of the water-discharge valve in order to remove any possible residual impurity.
- Once it has been disjuncted, the cube plate slides away from the evaporator and moves the front baffle (which is hinged in its upper portion) toward the outside and with simple gravity, falls into the container.
- The front baffle, while rotating back and forth, opens and closes the contacts to an electronic card, which, in turn restores the normal ice-production cycle.
- When the container is full, the last ice-cube plate keeps the baffle open and, therefore, the microswitch contacts do not close.
- Thus, the electronic card, connected to the microswitch, stops the machine within 30 seconds.
- The removal of the ice from the collecting box allows the baffle to restore its normal position, and therefore the producer is started again.
- A complete cycle takes from 15 to 30 minutes, depending on water and room temperature.
- In case of machine stopping because of irregular working, the LED nr. 4 lights up. Wait at least 3 minutes

from the alarm beginning, before prewashing reset. If the stopping happens again, consult the technical assistance.

UNDER UNFAVORABLE ELECTRICAL POWER SUPPLY THE MACHINE CAN GIVE A DROPPING TENSION WITH TRANSIENT STATE.

CLEANING AND MAINTENANCE

NOTE:

Observe safety practice: disconnect the machine from electricity supply before cleaning and maintenance operations.

CLEANING OF THE AIR CONDENSER

The gradual accumulation of dust in the condenser causes a significant reduction in the refrigerating action of the machine and consequently in its ice production. It is recommended to inspect frequently the condenser in the back of the machine and to clean in either with non-metallic brush, or better with a vacuum cleaner (pict. nr. 23).

CLEANING OF WATER INFLET FILTER

Close the shut-off valve of the water supply, take out the water inlet probe filter and rinse the filtering part under a water flush and reassemble.

CLEANING OF THE CABINET EXTERIOR

Clean using a clean cloth and warm water.

CLEANING OF THE AIR STORAGE BIN

Remove the ice from the storage bin. Clean the interior with a sponge wetted in warm water with a little sodium bicarbonate: rinse with clean water and dry thoroughly.

CLEANING OF THE WATER CIRCUIT

ATTENTION

The machine is equipped with a new semi-automatic washing device that enables the effective cleaning of the entire hydraulic system.

The washing operation should be carried out by a service technician.

The washing frequency depends upon the hardness of the water. It is advised that the washing operation is carried out at least twice a year.

Fleet type # 06291 ICE MAKER 138 kg
Manual # 316

INSTRUCTION MANUAL

MODE D'EMPLOI

BETRIEBSANLEITUNGEN

INSTRUCCIONES DE USO

SCOTSMAN[®]

B 193

B 393

B 350

B 550

B 120



ISO 9001
Cert. N° 0412/2



I NOSTRI IMPIANTI SONO CONFORMI ALLA DIRETTIVA BASSA TENSIONE 73/23 - 89/336 CEE

ISTRUZIONI D'USO

INTRODUCTION

The Scotsman/Frimont ice containers are constructed according to the same rigorous technical specifications as adopted for the ice makers.

By combining perfectly with the respective modular units, they provide a wide range of combinations for meeting the most varied requirements.

The basic concepts that inspired Frimont in the design and production of the current range of ice containers were: compact dimensions, in terms of both height and footprint, easy pickup of the ice, possibility of increasing the effective volume, duration and variety of storage capacity.

Various ice containers are now available, as specified below:

- models for modular units: B.350 - B.550
B.393 - B.193
- model for horizontal modular unit B.120

All with stainless steel finish.

CONTAINERS AND ACCESSORIES

B.193 - Container for modular unit

For use with the MV300, CM450SL modular ice cuber and the MF 22-30 ice flaker.

Capacity: 100 kg of ice cubes
 Height: 1035 ÷ 1095 mm with feet
 Width: 565 mm
 Depth: 825 mm

Shipping weight: 43 kg

B.193 Stainless steel finish
 Collection chamber in polyethylene and door in ABS

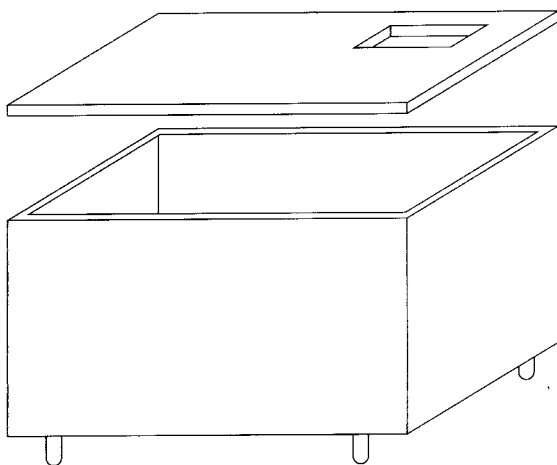

Cover for MF 22 - MF 30 installation.
 For installation of models MV 300 - CM 450 SL remove the cover from the up side bin.

B.393 - Container for modular unit

For use with MV 450-600-1000 modular ice cubers, with MF 22, MF 30, MF 41, MF 51 ice flakers and the NM modular crushed~ ice maker 654.

Capacity: 150 kg of ice cubes
 Height: 1035 ÷ 1095 mm with feet
 Width: 765 mm
 Depth: 825 mm

Shipping weight: 54 kg

B.393 S S tainless steel finish - Collection chamber in polyethylene and door in ABS

KBT 103 Container lid for ice flakers

B.193 - B.393 - Bin door hinge hardness adjusting

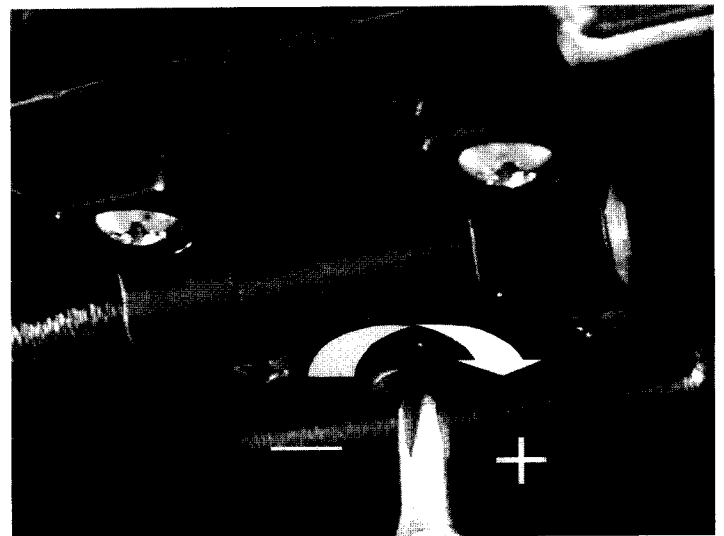

B.350 - Container for modular unit

For use with the MC 15 modular ice cuber.

Capacity:	150 kg of ice cubes
Height:	725 ÷ 785 mm with feet
Width:	1075 mm
Depth:	785 mm
Shipping weight:	52 kg
B.350 S	Stainless steel finish Collection chamber and door in ABS
KBE 75 S	Extension - Increases storage capacity by 35 kg
KBT 1	Container lid for ice flakers

B.550 - Container for modular unit

To be used with the MC 15, MC 45 modular ice cubers and with the MF 41, MF 51 ice flaker and with the NM 654 crushed-ice maker.

Capacity:	230 kg of ice cubes
Height:	955 ÷ 1015 mm with feet
Width:	1075 mm
Depth:	785 mm
Shipping weight:	63 kg
B.550 S	Stainless steel finish Collection chamber and door in ABS
KBE 75 S	Extension - Increases storage capacity by 35 kg
KBT 1	Container lid for ice flakers
KBT 253	Lid for MV modular units

B.120 - Container for modular horizontal unit

For use with MC 1210 modular ice cubers.

Capacity:	390 kg of ice cubes
Height:	896 mm with feet 737 mm without feet
Width:	1676 mm
Depth:	1072 mm
Shipping weight:	156 kg
B.120 S	Stainless steel finish - Collection chamber in stainless steel - Two doors in ABS

CONSIDERATIONS REGARDING THE INSTALLATION AND LOCATION OF THE CONTAINER

Place of installation

On the modular ice makers the ice container also serves as a support base for the production unit. When selecting the place of installation, it is therefore necessary to follow the instructions and advice given in the user instruction handbook.

Installation of the container

Check the outer packing to make certain that it has not been damaged in transit. After removing the box, inspect the container thoroughly both inside and out to make sure it has not been damaged during transport, loading or unloading.

Lie the container on its back, easing it onto the box it was packed in, in order to fit the four feet into their seats.

Stand the container up again, then position it in the installation site, making sure that the floor is even and capable of supporting the weight of the unit.

Level the ice container in both directions, from right to left and from front to back.

Check that the foam-rubber seal round the top edge of the container is in perfect condition; replace if necessary with food-grade sealant. If required, fit extension KBE 75 to the container (B350 - B550).

Water drainage connection

The drainage fitting, with an external diameter of 18 mm, is always located at the bottom or bottom back of the container, and must be connected, by means of a ventilated pipeline at a constant gradient, to an open-trap waste outlet.

Important

Before positioning the ice maker on the container, wash the inside of it with soap and water or with a handful of sodium bicarbonate diluted in two litres of warm water; then rinse and dry thoroughly.

ISTRUZIONI D'USO

HOW TO USE IT

NOTICE D'EMPLOI

GEBRAUCHSANWEISU

GEBRUIKSAANWIJZ

ISTRUCCION
PARA EL U

MANUAL DE U

BRUKSANVISNI

BRUKSANVISNI

BRUGSANVISNING

KÄTTÖHJE

ΟΑΗΓΙΕΣ ΧΡΗΣΕΩΣ

FABBRICATORI DI GHIACCIO

ICEMAKING MACHINES

M: 689

06291

Ice Maker 138 kg

SCOTTSMAN

ISLÁGING SMASKINENE
JÄÄKUITIOK ONEILLA
ΜΗΧΑΝΕΣ ΝΑΡΑΓΩΓΗΣ ΜΑΓΟΥ

MV 306

MV 426

MV 456

MV 606

MV 806

MV 1006



I NOSTRI IMPIANTI SONO CONFORMI ALLA DIRETTIVA 2006/95/CE - 2004/108/CE

scottsman®

ISTRUZIONI D'USO

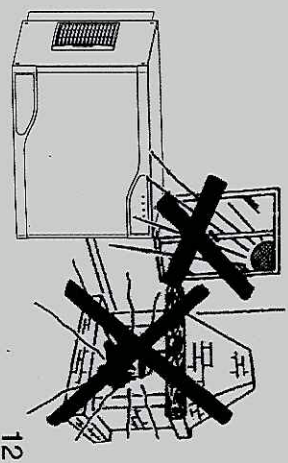
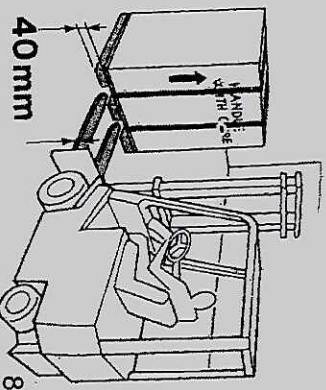
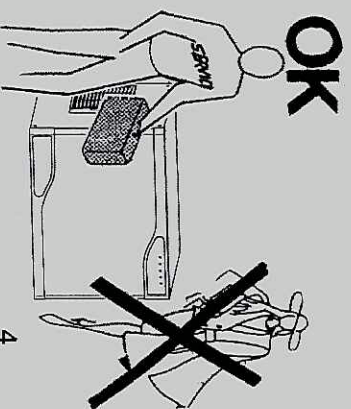
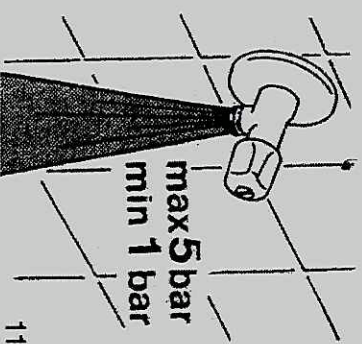
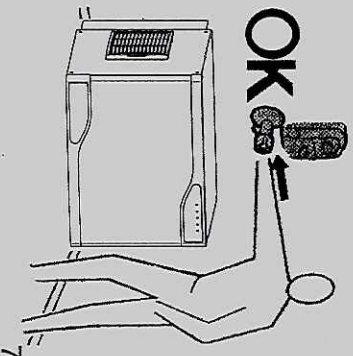
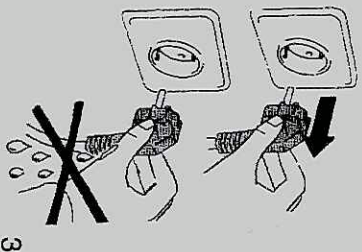
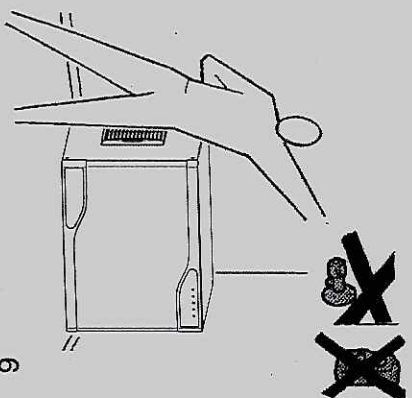
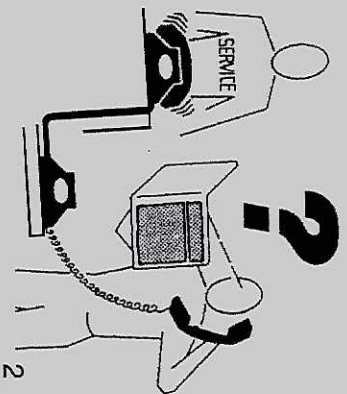
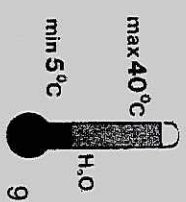
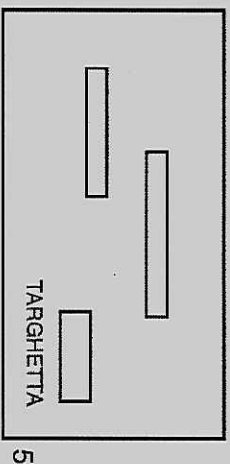
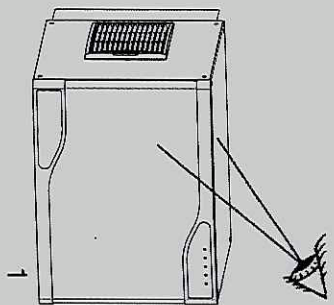

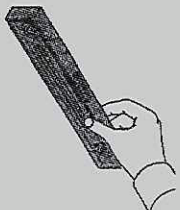

13

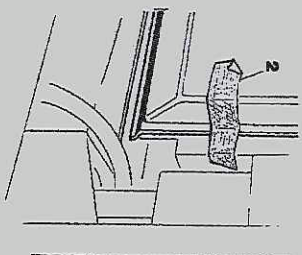

17

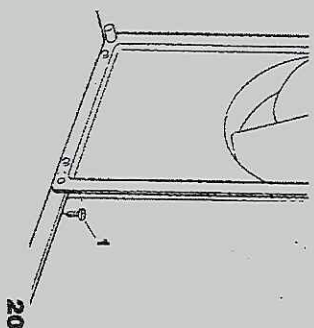

20

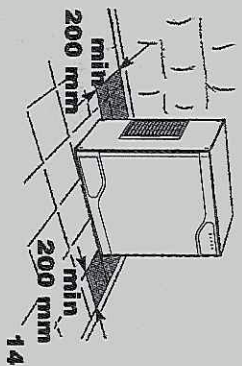

14

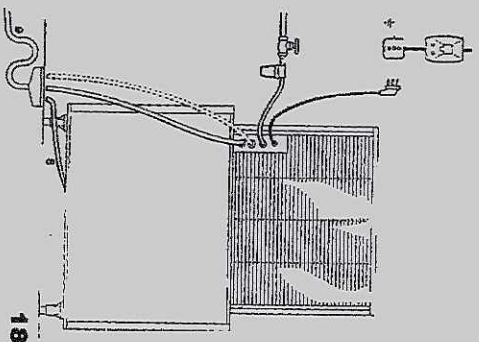

18

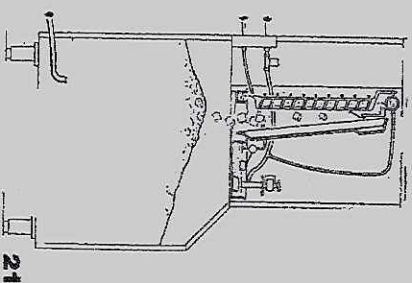

21

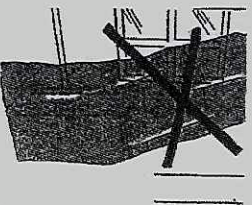

15

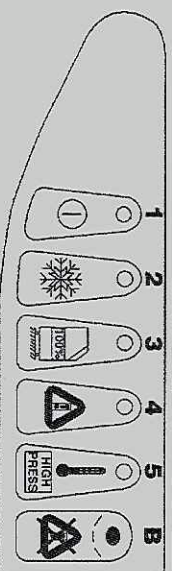

- | | |
|---|--------------------------------------|
| LED N° 1
Relè. | LED N° 1
Electrical power supply. |
| LED N° 2
Funzionamento. | LED N° 2
Operation. |
| LED N° 3
Deposito pieno/avaggio. | LED N° 3
Tank full/Washing. |
| LED N° 4
Allarme. | LED N° 4
Alarm. |
| LED N° 5
Allarme alla pressione. | LED N° 5
Alarm high pressure. |
| PULSANTE B ROSSO
Pulsante
Reset/avaggio. | BUTTON B
Reset/Washing. |

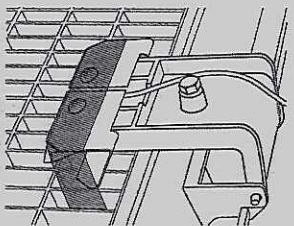

16

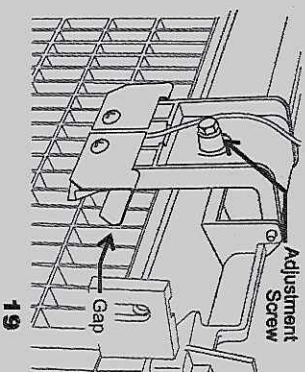

19

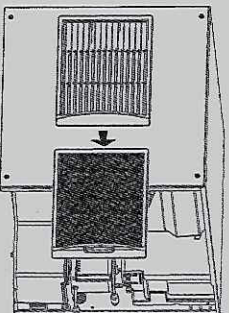

23

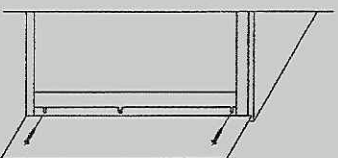

24

DEFLETTORE
AIR DEFLECTOR

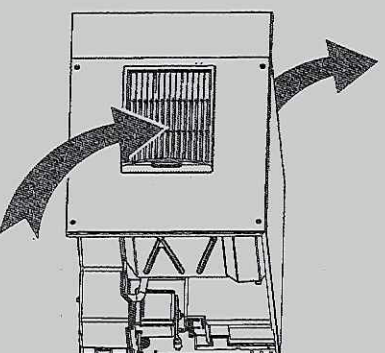



WARNING!!!
IT IS EXPRESSLY FORBIDDEN FOR THE USERS OF THE EQUIPMENT TO CARRY OUT THE FOLLOWING OPERATION OR THOSE MARKED BY THE SYMBOL. SUCH OPERATIONS MUST BE PERFORMED EXCLUSIVE BY QUALIFIED PERSONNEL.

1. ELECTRICAL CONNECTIONS
2. WATER MAINS CONNECTIONS
3. MACHINE INSTALLATION
4. MACHINE TEST RUN
5. REPAIRING MACHINE COMPONENTS AND PARTS
6. DISASSEMBLY OF MACHINE AND/OR COMPONENTS
7. ADJUSTMENT AND SETTING PROCEDURES
8. MACHINE CLEANING AND MAINTENANCE RELATIVE TO THE FOLLOWING PARTS AND COMPONENTS:
ELECTRICAL,
ELECTRONIC,
MECHANICAL,
COOLING SYSTEM.

GENERAL SPECIFICATIONS

CE OUR PRODUCTS ARE GOVERNED BY EC LOW TENSION DIRECTIVE 2006/95/CE - EMC - 2004/108/CE AND THE COVER OF THE MANUAL IS MARKED ACCORDINGLY.

ATTENTION:

This appliance is not intended for use by persons -including children- with reduced physical, sensory or mental capabilities, or lack of experience and knowledge, unless they have been given supervision or instruction concerning use of the appliance by a person responsible for their safety. Children should be supervised to ensure that they do not play with appliance.

INSTALLATION

Before bringing the icemaker into action perform the following operations:

- 1) Check that ice maker has not been damaged during transport (pict. nr. 1)
- 2) Match the producer to its storage bin, fixing them with the two screws supplied with the machine (pict. nr.20).
- 3) Clean the inside of machine by means of a warm water and sodium-bicarbonate dampened sponge; rinse with plain water and dry accurately.
- 4) Locate the producer and the storage bin in the final place, making sure that the two are perfectly sport-levelled, in order to obtain an even distribution of the water all over the evaporator and a regular falling of the cube plate (pict. nr.13).

The storage bin is equipped with height adjustable feet, which allow for an easy levelling and comfortable future cleaning of the floor.

- 5) Release the stops on the deflector and remove it to avoid it getting damaged during transportation (fig. n° 17).
- 6) Do not put the machine in dusty place because this could cause a fast obstruction of the condenser (only fro aircooled models).
- 7) Never keep food, bottles or other things in the bin in order to avoid that the ice takes bad smells and tastes.
- 8) Connect machine to water supply fist and then to electricity supply.

ATTENTION:

The icemaker must be connected to a POTABLE WATER SUPPLY

NOTE:

Before installing the machine make sure that:

- a) the room temperature must not fall below 10°C (50° F) or above (100° F).
- b) the water conductivity value must be not below than 10 μ s/cm.
- c) The machine does not take demineralised water.
- d) the main water temperature must not fall below 5°C (40° F) or above 35°C (95° F).
- e) the main water pressure must not fall below 1 bar (14 PSI) or above 5 bar (70 PSI). If pressure is above 5 bar a pressure regulator should be fitted on the water supply machine (pict. nr. 11).
- f) machine is awais from sources of heat and in a sufficiently ventilated area. A distance of a least 20 cm must be foreseen between the sides/the back of the machines and the walls (pict. nr. 12 - nr. 14).

- 9) Connect the 3/4" Feeding pipe (supplied) to the machine and to the cold drinking water supply line. It is advisable to install a shut-off (not supplied) to the water feeding pipe. If the feeding water of impurities, the applications of a filter water-supply system is recommended. If the water is particularly hard, i.e. rich in minerals and their derivatives, the application of a proper water softener is recommended. Thus, anyscaling of therydraulic circuit of the machine can be avoided (pict. nr. 18).
- 10) Apply the two-duplicated fixrble pipes to the machine-container discharge connectors. For a perfect water outlet from the machine a minimum incline of 3% of the pipes is advisable. Check also that the pipes are non throttled or siphoned. It is advisable that the pipes discharge in an open vented drain(pict. nr. 18).
- 11) Connect the machine to the electricity supply after having checked that the voltage corresponds to that on the plate on the rear panel of the machine (pict. nr. 5).
- 12) Air deflector installation. (pict. nr. 24) The deflector has to be installed in order to prevent hot air recirculation in the condenser.

The maximum voltage variation should not exceed \pm 6% of that stated on the rating plate. Provide for a feeding circuit to the machine, with its own bipolar main switch at least 3 mm. of contacts opening. The machine should be connected to an independent fuse or suitable power supply with earth terminal. The whole system must be calibrated according to the power machine indicated on the registration label.

A DIFFERENTIAL SWITCH MUST BE INCLUDED IN THE ELECTRICAL CIRCUIT.

INFORMATION FOR THE "SERVICE"

THE FOLLOWING OPERATIONS MUST BE CARRIED OUT BY QUALIFIED PERSONNEL

STARTING THE MACHINE

WARNING: Do not let the device run before our technician's invention.

Before starting the ice producer perform the following:

- a) Remove the coverand the side.
- b) Check that the compressor is free to swing on the rubbers on the relative stirrups and that che fans od the electric fan turn freely.

Moreover:

- 1) Verify that the water supply valve is open; then connect the machine electrical plug to the socket and switch on the main switch; the machine starts working automatically.
- 2) Check if the water pumps work regularly (30" delay).
- 3) Check that the water flows regularly on the evaporator and that there are no leakages in the water-piping system.
- 4) Verify any irregular vibrations.
- 5) To adjust the cube height, action the screw nr. 1 (pict. nr. 19) which determines the distance between the sensor reeds and the evaporator. The distance (fixed by us) is of about 4 mm for a normal ice cube.
- 6) Check an ice production cycle ensuring that the cube plate is conveyed into the storage bin and that all operations are performed regularly.
- 7) Verify the working of the machine-stopping microswitch by keeping the splash-guard deflector open for over 30 seconds.
- 8) Put on the panels you have removed before.
- 9) The front panel is equipped with 5 "LEDS" next to the symbols corresponding to the following functions:

LED Nr. 1
Electrical power supply.

LED Nr. 2

Operation.

LED Nr. 3

Tank full/Washing

LED Nr. 4

Alarm.

LED Nr. 5

Alarm high pressure.

BUTTON B

Reset/Washing.

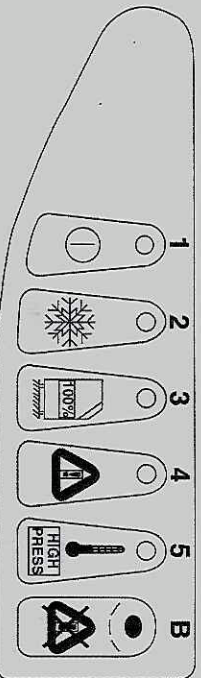

Attention

The machine is equipped with a maximum pressure switch with manual reset.

Red pilot light lit LED 5: alarm due to a raised condensation pressure, the machine stops.

FUNCTIONING:

The ice cubes are produced within a special hive-like vertical copper evaporator.

A circulation pump produces a continuous water flow on the grout grid; gradually, a portion of the water turns into ice on the inner walls of the small coils and forms cubes, the height of which is controlled by a special adjustable sensor. Such a sensor is made up of two metal reeds, which are fed by a low-voltage circuit. (Insulated between themselves), and kept at a certain distance (adjustable through a screw) from the evaporator. As the ice is produced, the water film flowing on the ice itself approaches the two reeds finally touches them, thus closing the electronic circuits which causes at the same time:

- The sending of warm gas to the evaporator, by opening a solenoid valve, and the consequent disjunction of the cube plate from the evaporator.

The machine also features an electromechanical pushing device for detaching blocks of ice from the evaporator (to the exception of the model MV306).

- The opening of the water-discharge valve in order to remove any possible residual impurity.

Once it has been disjuncted, the cube plate slides away from the evaporator and moves the front baffle (which is hinged in its upper portion) toward the outside and in with simple gravity, falls into the container.

The front baffle, while rotating back and forth, opens and closes the contacts to an electronic card, which, in turn restores the normal ice-production cycle.

When the container is full, the last ice-cube plate keeps the baffle open and, therefore, the microswitch contacts do not close. Thus, the electronic card, connected to the microswitch, stops the machine within 30 seconds.

The removal of the ice from the collecting box allows the baffle to restore

its normal position, and therefore the producer is started again.

A complete cycle takes from 15 to 30 minutes, depending on water and room temperature. In case of machine stopping because of irregular working, the LED nr. 4 lights up.

UNDER UNFAVORABLE ELECTRICAL POWER SUPPLY THE MACHINE CAN GIVE A DROPPING TENSION WITH TRANSIENT STATE.

Wait at least 3 minutes from the alarm beginning, before prewssing reset. If the stopping happens again, consult the technical assistance.

☐ CLEANING AND MAINTENANCE

NOTE: Observe safety practice: disconnect the machine from electricity supply before cleaning and maintenance operations.

☐ CLEANING OF THE AIR CONDENSER

The gradual accumulation of dust in the condenser causes a significant reduction in the refrigerating action of the machine and consequently in its ice production. It is recommended to inspect frequently the condenser in the back of the machine and to clean in either with a non-metallic brush, or better with a vacuum cleaner (pict. nr. 23).

☐ CLEANING THE WATER INLET VALVE FILTER

Close the shut-off valve of the water supply, take out the water inlet probe filter and rinse the filtering part under a water flush and reassemble.

☐ CLEANING OF THE CABINET EXTERIOR

For the cleaning of the unit cabinet use a soft cloth with a mild detergent solution specific for Stainless Steel.

☐ CLEANING OF THE AIR STORAGE BIN

Remove the ice from the storage bin. Clean the interior with a sponge wetted in warm water with a little sodium bicarbonate: rinse with clean water and dry thoroughly.

☐ CLEANING OF THE WATER CIRCUIT

ATTENTION

The machine is equipped with a new semi-automatic washing device that enables the effective cleaning of the entire hydraulic system.

The washing operation should be carried out by a service technician. The washing frequency depends upon the hardness of the water. It is advised that the washing operation is carried out at least twice a year.

DISPOSAL OF WASTE ELECTRONIC AND ELECTRICAL EQUIPMENT (WEEE)

Fulfilling Directives 2002/95/CE, 2002/96/CE and 2003/108/CE on the disposal of waste electronic and electrical equipment.

The crossed out wheeled bin symbol indicates the product must be collected separately from other waste when it has become redundant. Differentiated collection of this equipment is arranged and handled by the manufacturer. Consequently, the user who is wanting to dispose of this equipment must contact the manufacturer and follow the method the latter has adopted to allow separate collection of the redundant equipment.

Appropriate differentiated collection for the subsequent recycling, treatment and eco-friendly disposal of the dismantled equipment prevents possible negative effects on the environment and health and facilitates the recycling of materials used in manufacturing the equipment.

Administrative sanctions foreseen by the regulations in force shall be applied for any abusive disposal of the product by the holder.