

Pump - For use anywhere

12V Pump 21 Amp

Portable-Submersible
Model P3010

1-3

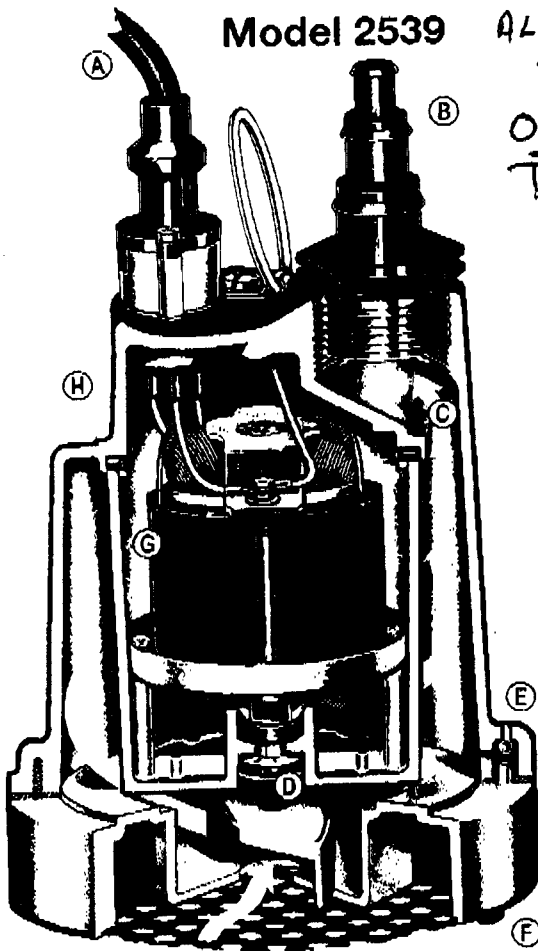

Model 2539

ALSO 2533
" D6601

ONLY INLET CABLE
DIFFERENCE
10 METRE CABLE

Simer Geyser

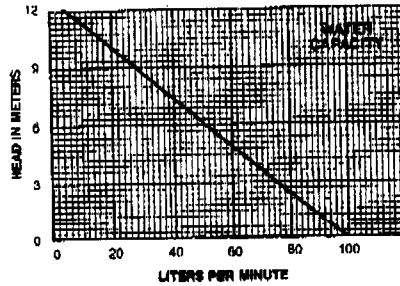

MODEL P3010-12 Volt, 21 Amp

- 12 Volt DC battery powered
- Rugged thermoplastic construction
- 1-1/4" discharge with garden hose adapter
- Quiet operation
- 2.5 metre (8') cable
- Compact design fits into 177mm (7") opening
- Anti-airlock valve
- Portable - weighs approximately 4 kilos
- Corrosion resistant
- Field replaceable power cord

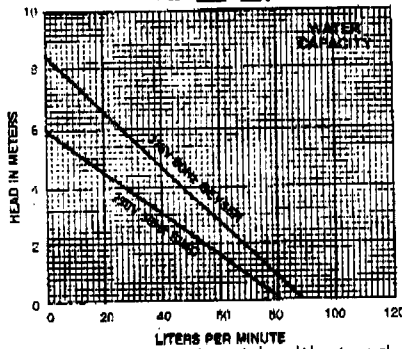

A portable pump should withstand rough handling. The all-metal Simer/Geyser is noted for its ability to stand "hard knocks".

Fast and powerful, light and compact, only 24 cm high and 17 cm in diameter, 4.5 kilos; sealed (no service required) — the Simer/Geyser will give years of quiet dependable service.

THE INSIDE STORY

- (A) NEW Replaceable 2.5 or 10 metre power cable
- (B) NEW 1 1/4" BSP discharge with 3-step hose adapter
- (C) Water cooled motor housing
- (D) Lifetime ceramic face seal (Permits dry running)
- (E) Anti-Air Lock valve
- (F) Screened bottom inlet, pump to within 3 mm of floor
- (G) Simer built, oil filled motor with overload protection
- (H) All tough cast metal construction, epoxy coated inside and out

Model 2539 10 m cord **D6601**

USE IT ANYWHERE. Operates on battery power — no electrical outlet needed. Gives you pumping power for basements, boats, construction sites, on the farm, in camp or lake cottage. Provides low voltage operation for continuous use in fountains or waterfalls. Can be used as an emergency sump pump where regular power is unavailable.

PUMPS DOWN TO 3 mm. Geyser does a complete pumping job — bottom inlet screen keeps Geyser working where other pumps can't — pumps to within 1/8" (3 mm) of surface.

PERFORMANCE POWER!

Geyser P3010 is high performance pump, providing ample pumping pressure. Pumps up to 98 litres (26 gal.) per minute.

ABN 45 003 63079

METROPOLITAN INDUSTRIAL SUPPLIES PTY. LTD.

ACN 003 630 797



Unit 1, 133 Coreen Avenue, Penrith NSW 2750 Australia
Phone: 47 31 2005 — Fax: 47 31 3605

02-

02-

THIS MANUAL SUPPLIED WITH EVERS
PUMP SUPPLIES



OWNER'S MANUAL

MODELS: 6901 through 6906
7101 through 7106

* D6601 *

23

Submersible Utility Pump

INTRODUCTION:

All Simer pumps are carefully designed and tested to provide quiet operation and long life. Your new Simer Submersible Utility Pump has been inspected and packaged to insure it arrives in perfect condition. Examine your pump closely to make sure there are no broken or damaged parts that may have occurred in transit. If any damage is noticed, return pump to place of purchase for replacement. Please be sure to read these instructions carefully, paying special attention to any **WARNING** or **CAUTIONS** to assure proper installation and operation.

VERY IMPORTANT SAFETY INFORMATION:

Always follow these rules to avoid bodily injury or property damage.

- 1. (WARNING) Risk Of electrical shock—**
This pump is supplied with a three conductor connection, including ground wire. To reduce the risk of electric shock, be certain that it is connected only to a **PROPERLY** grounded, grounding type receptacle.

1) ELECTRICAL CONNECTION (MODELS 6902 & 7102 are supplied without wall plugs.)

(a) As the colours of the wires in the main leads of this appliance may not correspond with the coloured marking identifying the terminals in your plug, proceed as follows: The wire which is coloured green and yellow must be connected to the terminal in your plug which is marked with letter "E", by the Earth symbol, or coloured green or green and yellow. The wire which is coloured blue must be connected to the terminal which is marked by the letter "N" or coloured black. The wire which is coloured brown must be connected to the terminal which is marked with the letter "L" or coloured red.

(b) ELECTRICAL SAFETY WARNING:

In accordance with the latest I.E.E. regulations, but particularly for your added safety, the use of a Residual Current Device (RCD), otherwise

known as an Earth Leakage Protection Device is required. The Earth Leakage circuit-breaker must have a rated tripping current of not more than 30ma. These are not generally available from all good Electrical and "DIY" Superstore.

IF IN DOUBT, PLEASE CONSULT A QUALIFIED ELECTRICIAN.

- 2. (WARNING) RISK OF Electric shock** This pump has not been investigated for use in swimming pool areas. Do not use when persons are in the pool.
- 3. (WARNING) Electric shock hazard—** may cause severe personal injury, death or substantial property damage. For your safety, turn off the electrical power supply at the service entrance before installing or servicing the pump to avoid any possible electrical shock hazards. Never make adjustments to a pump when the power is connected. When changing fuses, never stand in water or put your fingers in the fuse box socket. Either practice can result in a dangerous or even fatal electric shock.
- 4. (WARNING) Electrical shock hazard—** may cause severe personal injury, death or substantial property damage.

RECOMMENDED GROUNDING METHOD:

Machine Type - 1424

Simer Pump 240 volt.

Manual # 441



OPERATION MANUAL BPS-100 SERIES

Red.

Dear Client,

Congratulations on your purchase of this pump products. Like all Arwana pumps products. We had developed with the help of the latest technologies and manufactured with the most advanced electrical/motor parts.

Please check the following point upon receipt of your pump:

- (1) Is the pump exactly what you ordered? Check the nameplate, please.
Is the frequency of the power supply correct? (50Hz or 60Hz power please check again)
- (2) Has any damage occurred during shipment? Are any bolts or nuts loose?
Take the time to read the instructions carefully before using this appliance.

We are strongly to recommend that you keep this instruction manual in a safe place for future reference.

Specifications

TYPE	OUTPUT		DISCHARGE		RATED		MAXIMUM		Dimension	Weight
	HP	W	mm	inch	head	capacity	head	capacity	(mm)	
					M	LPM	M	LPM	L x W x H	kg
BPS-100	1/6	100	25	1	4	35	6	70	155x155x240	2.9
BPS-100A	1/6	100	25	1	4	35	6	70	155x155x240	3.1
BPS-100V	1/6	100	25	1	4	35	6	70	155x155x240	3.1

Check the nameplate for your pump's specification as the table list.

Be careful not to exceed the given specifications in the use of your pump.

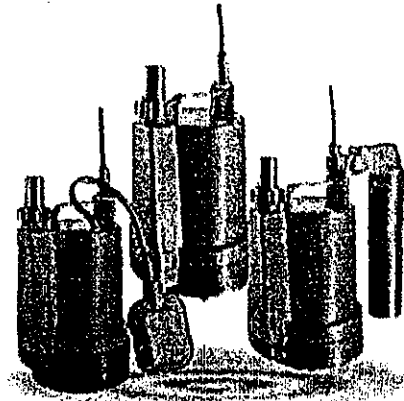
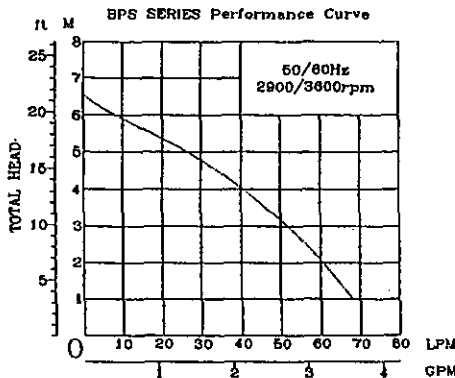

BPS-100A

BPS-100

BPS-100V

Marks and meaning:



DANGER Keep the pump equipment out of the reach of children!

DANGER

DANGER Warns that the failure to follow the directions given could cause serious risk to individuals or objects.



WARNING

WARNING This sign warns the operator that the failure to follow an instruction may damage the pump and/or the system.

WARNING This pump is designed for residential clean water "spot" jobs and cannot be used as a continuous duty sump pump or fountain pump.

Limitations:

This series pumps are suitable to pump water and be careful the water's suspension particles, it can't be over 4mm, or it will stock the bottom strainer.

The pump could be placed for sump pit that means it could pump fresh water of tunnel, route.

The fluid's temperature-limit is 40 centigrade (104 °F) high only, be careful not to pump hot water, otherwise it will damage the pump's life soon.



The pump cannot be used for sea water and inflammable, corrosive, explosive or dangerous liquids.
Verify that the electro pump never runs without liquids.

Installation:

Do not work on pump until power is unplugged.
Do not cut off ground pin or use an adapter fitting.
Do not use an extension cord.



Do not handle the pump by the wire, that will cause the failure from the power cord when it run a long period time.
Do not position the pump into a un-identify site which you don't know the Max. Diameter particles mixed with the water.

The pump power cord should be connected to a separately fused, grounded line with a minimum capacity of 15 amps.
It can be connect to non- fuse breaker as the recommended amperes. Never touch the pump when it is connected to electrical power.

1. Before installing or servicing this pump, be certain pump power source is disconnected.
2. Installation and electrical wiring must adhere to state and local codes and must be completed before priming pump.
Check appropriate community agencies, or contact local electrical and pump professionals.
3. Call an electrician when in doubt. Pump should be connected to a separate 15 amps circuit breaker or 15 amps fuse block.
Note that, plugging into existing outlets may cause low voltage at motor, causing blown fuses, tripping of motor overload, or burned out motor.
4. A permanent ground connection from pump to the grounding bar at the service panel is mandatory. ARWANA sump pumps come with a grounding conductor and a grounding-type attachment plug.
Do not connect pump to a power supply until permanently grounded. For maximum safety, ground pump to a circuit equipped with a fault interrupter device.
5. Voltage of power supply must match the voltage of the pump.
6. Before installing pump, clear sump basin of any water, debris, or sediment.
Warning: Sump basin must be vented in accordance with local plumbing codes. ARWANA Sump pumps are not designed for and CANNOT be installed in locations classified as hazardous.
7. The following may cause severe damage to pump and will void warranty:
 - (a) Using an extension cord.
 - (b) Cutting off the ground pin or using an adapter fitting.
 - (c) Working on pump or switch while plugged in.
 - (d) Removing motor housing, unscrewing impeller, or otherwise removing impeller seal
 - (e) Pumping chemicals or corrosive liquids.
 - (f) Pumping gasoline or other flammable liquids.
 - (g) Pumping hot liquids. (exceed 40 centigrade)(over 104 °F)



When the pump reach to an overheat level, it will shut-off automatically, once it cooled down either naturally or by being submerged in a bucket of cold water (5+ gallons for 20 minutes more).
The pump will reset and can ready to pump again.

8. The simple way to connect this ARWANA Utility Pump
 - STEP 1: Connect a standard garden house to the utility pump threaded discharge.
 - STEP 2: Place the utility pump into the water to be pumped.
 - STEP 3: Move away from the area to be pumped, and while standing on dry and grounded outlet.

Electrical wire Connection:



Verify that the voltage and frequency of the electro pump shown on the nameplate correspond to those available on the mains.
The installer must make sure that the electric system is grounded in accordance with the law in force.

It is necessary to use cable with a length of 10m for outdoors using. The plug and connections should be protected from water splashes. Before using the pump, always inspect it visually (especially power cable and plug).

Do not use the pump if it is damaged.

If the pump is damaged, have it inspected by the specialized assistance service only.

Make sure that electric connections are protected from inundation. Protect the plug and the power cable from heat, oil or the power cable must be replaced by qualified personnel only.



Grounding: The plug of the power cable has a double grounding contact, so that grounding can be performed by simply inserting the plug.

Overload protection:

This series pump have a built in thermal protection switch. The pump stops if an overload condition occurs. The motor restarts automatically after it has cooled down when the built in thermal protector works.

Limited Warranty

ARWANA PUMP will repair or replace for the original user any portion of a new ARWANA PUMP product which prove defective due to materials or workmanship of ARWANA PUMP.

Contact the nearest authorized ARWANA PUMP dealer for warranty service.

ARWANA PUMP shall possess the sole right to determine whether to repair or replace defective equipment, parts or components.

THIS WARRANTY DOES NOT COVER DAMAGE DUE TO LIGHTING OR OTHER CONDITIONS BEYOND THE CONTROL OF ARWANA PUMP .

PUMPS: Warranted 12 months from date of purchase or 15 months from the date of manufacture.

Receipt and product date code required for warranty claim.

LABOR & COSTS: ARWANA PUMP shall in no event be liable for the cost of field labor to other charges incurred by any customer in removing and/or reaffixing any ARWANA PUMP product, parts or component.

THE WARRANTY WILL NOT APPLY:

- (a) to defects or malfunctions resulting from failure to properly install, operate, or maintain the unit in accordance with printed instructions provided.
- (b) to failures resulting from abuse, accident, or negligence.
- (c) to normal maintenance services and the parts used in connection with such service.
- (d) to units which are not installed in accordance with applicable local codes, ordinances, and good trade practices.
- (e) if the unit is moved from its original installation location.
- (f) if unit is used for purposes other than for what it was designed and manufactured for.

WARRANTY EXCLUSIONS: ARWANA PUMP

SPECIFICALLY DISCLAIMS THE IMPLIED WARRANTIES OF MERCHANTABILITY AND FITNESS FOR A PARTICULAR PURPOSE AFTER THE TERMINATION OF THE WARRANTY PERIOD.

Guarantee

The right to claim under guarantee must be proven by the purchaser by presentation of the purchase invoice.

Note:

1. Should your equipment not function correctly, please firstly check, whether other reasons, e.g. interruption of the power supply, or incorrect handling are the cause.
2. Please note that it is imperative that the following documents and details are produced together with your faulty equipment:
 - (a) Purchase receipt
 - (b) Designation of the apparatus/type/brand
 - (c) Description of the noted defect (an accurate description of the defect makes a rapid repair easier for us)

In the case of a claim for guarantee or defects, please contact the place of purchase.

TROUBLESHOOTING CHECKLIST (CAUTION: SHUT OFF POWER TO PUMP)

PROBLEMS	POSSIBLE CAUSES
Pump does not run and hums	<ul style="list-style-type: none"> * Line circuit breaker is off, or fuse is burned or loosed. * Water level in sump has not reached turn-on level as indicated in installation drawing. * Pump cord is not making contact in receptacle. * Float is stuck. It should operate freely in basin. * If all of the above are OK, and then the motor winding can be re-start again.
Pump runs but does not deliver water.	<ul style="list-style-type: none"> * Check valve is installed backwards. Arrow on valve should point in direction of flow. * Discharge shut-off valve (if used) may be closed. * Impeller or volute openings are fully or partially clogged. Remove pump and clean. * Pump is air-locked. Start and stop several times by plugging and unplugging cord. Check for clogged vent hole in pump case. * Inlet holes in pump base are clogged. Remove pump and clean the openings. * Vertical pumping distance is too high. Reduce distance or change the discharge fittings of the pump.

1424

664



OPERATION MANUAL BPS-100 SERIES

Dear Client,

Congratulations on your purchase of this pump products. Like all Anwana pumps products. We had developed with the help of the latest technologies and manufactured with the most advanced electrical/motor parts.

Please check the following point upon receipt of your pump:

- (1) Is the pump exactly what you ordered? Check the nameplate, please.
Is the frequency of the power supply correct? (50Hz or 60Hz power please check again)
- (2) Has any damage occurred during shipment? Are any bolts or nuts loose?

Take the time to read the instructions carefully before using this appliance.
We are strongly to recommend that you keep this instruction manual in a safe place for future reference.

Specifications

TYPE	OUTPUT		DISCHARGE		RATED		MAXIMUM		Dimension (mm)		Weight kg
	HP	W	mm	inch	head M	capacity LPM	head M	capacity LPM	L x W x H		
BPS-100	1/6	100	25	1	4	35	6	70	155x155x240	2.9	
BPS-100A	1/6	100	25	1	4	35	6	70	155x155x240	3.1	
BPS-100V	1/6	100	25	1	4	35	6	70	155x155x240	3.1	

Check the nameplate for your pump's specification as the table list.
Be careful not to exceed the given specifications in the use of your pump.

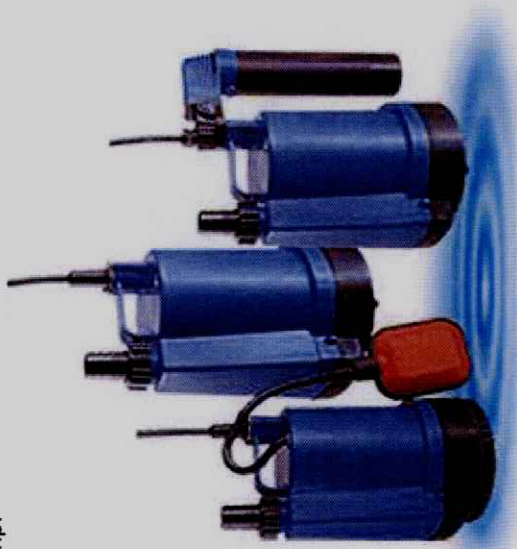
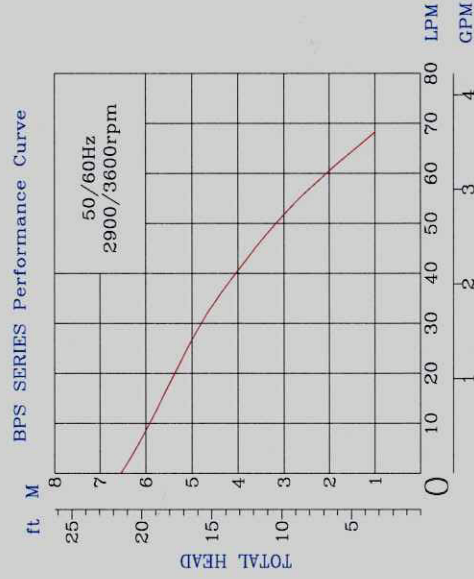

Marks and meaning:



DANGER

DANGER Keep the pump equipment out of the reach of children!

DANGER Warns that the failure to follow the directions given could cause serious risk to individuals or objects.

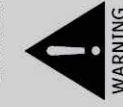

WARNING

WARNING This sign warns the operator that the failure to follow an instruction may damage the pump and/or the system.

WARNING This pump is designed for residential clean water "spot" jobs and cannot be used as a continuous duty sump pump or fountain pump.

Limitations:

This series pumps are suitable to pump water and be careful the water's suspension particles, it can't be over 4mm, or it will stock the bottom strainer.

The pump could be placed for sump pit that means it could pump fresh water of tunnel, route.

The fluid's temperature-limit is 40 centigrade(104 °F)high only, be careful not to pump hot water, otherwise it will damage the pump's life soon.

1424 664



WARNING

The pump cannot be used for sea water and inflammable, corrosive, explosive or dangerous liquids. Verify that the electro pump never runs without liquids.

Installation:

Do not work on pump until power is unplugged.
Do not cut off ground pin or use an adapter fitting.
Do not use an extension cord.

Do not handle the pump by the wire, that will cause the failure from the power cord when it run a long period time.
Do not position the pump into a un-identify site which you don't know the Max. Diameter particles mixed with the water.



WARNING

The pump power cord should be connected to a separately fused, grounded line with a minimum capacity of 15 amps. It can be connect to non- fuse breaker as the recommended amperes. Never touch the pump when it is connected to electrical power.

1. Before installing or servicing this pump, be certain pump power source is disconnected.
2. Installation and electrical wiring must adhere to state and local codes and must be completed before priming pump. Check appropriate community agencies, or contact local electrical and pump professionals.

3. Call an electrician when in doubt. Pump should be connected to a separate 15 amps circuit breaker or 15 amps fuse block. Note that, plugging into existing outlets may cause low voltage at motor, causing blown fuses, tripping of motor overload, or burned out motor.

4. A permanent ground connection from pump to the grounding bar at the service panel is mandatory, **ARWANA** sump pumps come with a grounding conductor and a grounding-type attachment plug.

Do not connect pump to a power supply until permanently grounded. For maximum safety, ground pump to a circuit equipped with a fault interrupter device.

5. Voltage of power supply must match the voltage of the pump.

6. Before installing pump, clear sump basin of any water, debris, or sediment.

Warning: Sump basin must be vented in accordance with local plumbing codes. **ARWANA** Sump pumps are not designed for and **CANNOT** be installed in locations classified as hazardous.

7. The following may cause severe damage to pump and will void warranty:

- Using an extension cord.
- Cutting off the ground pin or using an adapter fitting.
- Working on pump or switch while plugged in.
- Removing motor housing, unscrewing impeller, or otherwise removing impeller seal
- Pumping chemicals or corrosive liquids.
- Pumping gasoline or other flammable liquids.
- Pumping hot liquids. (exceed 40 centigrade)(over 104 °F)

When the pump reach to an overheat level, it will shut-off automatically, once it cooled down either naturally or by being submerged in a bucket of cold water (5+ gallons for 20 minutes more).
The pump will reset and can ready to pump again.



WARNING

8. The simple way to connect this **ARWANA** Utility Pump

STEP 1: Connect a standard garden hose to the utility pump threaded discharge.

STEP 2: Place the utility pump into the water to be pumped.

STEP 3: Move away from the area to be pumped, and while standing on dry and grounded outlet.

Electrical wire Connection:

Verify that the voltage and frequency of the electro pump shown on the nameplate correspond to those available on the mains.

The installer must make sure that the electric system is grounded in accordance with the law in force.



WARNING

It is necessary to use cable with a length of 10m for outdoors using. The plug and connections should be protected from water splashes. Before using the pump, always inspect it visually (especially power cable and plug).
Do not use the pump if it is damaged.

If the pump is damaged, have it inspected by the specialized assistance service only.

Make sure that electric connections are protected from inundation. Protect the plug and the power cable from heat, oil or the power cable must be replaced by qualified personnel only.

Grounding: The plug of the power cable has a double grounding contact, so that grounding can be performed by simply inserting the plug.



WARNING

1424 664

Overload protection:

This series pump have a built in thermal protection switch. The pump stops if an overload condition occurs. The motor restarts automatically after it has cooled down when the built in thermal protector works.

Limited Warranty

ARWANA PUMP will repair or replace for the original user any portion of a new ARWANA PUMP product which prove defective due to materials or workmanship of ARWANA PUMP. Contact the nearest authorized ARWANA PUMP dealer for warranty service. ARWANA PUMP shall possess the sole right to determine whether to repair or replace defective equipment, parts or components.

THIS WARRANTY DOES NOT COVER DAMAGE DUE TO LIGHTING OR OTHER CONDITIONS BEYOND THE CONTROL OF ARWANA PUMP.

PUMPS: Warranted 12 months from date of purchase or 15 months from the date of manufacture. Receipt and product date code required for warranty claim.

LABOR & COSTS: ARWANA PUMP shall in no event be liable for the cost of field labor to other charges incurred by any customer in removing and/or reaffixing any ARWANA PUMP product, parts or component.

THE WARRANTY WILL NOT APPLY:

- (a) to defects or malfunctions resulting from failure to properly install, operate, or maintain the unit in accordance with printed instructions provided.
- (b) to failures resulting from abuse, accident, or negligence.
- (c) to normal maintenance services and the parts used in connection with such service.
- (d) to units which are not installed in accordance with applicable local codes, ordinances, and good trade practices.
- (e) if the unit is moved from its original installation location.
- (f) if unit is used for purposes other than for what it was designed and manufactured for.

WARRANTY EXCLUSIONS: ARWANA PUMP SPECIFICALLY DISCLAIMS THE IMPLIED WARRANTIES OF MERCHANTABILITY AND FITNESS FOR A PARTICULAR PURPOSE AFTER THE TERMINATION OF THE WARRANTY PERIOD.

Guarantee

The right to claim under guarantee must be proven by the purchaser by presentation of the purchase invoice. Note:

1. Should your equipment not function correctly, please firstly check, whether other reasons, e.g. interruption of the power supply, or incorrect handling are the cause.
2. Please note that it is imperative that the following documents and details are produced together with your faulty equipment: (a) Purchase receipt
(b) Designation of the apparatus/type/brand
(c) Description of the noted defect (an accurate description of the defect makes a rapid repair easier for us)

In the case of a claim for guarantee or defects, please contact the place of purchase.

TROUBLESHOOTING CHECKLIST (CAUTION: SHUT OFF POWER TO PUMP)

PROBLEMS	POSSIBLE CAUSES
Pump does not run and hums	<ul style="list-style-type: none"> * Line circuit breaker is off, or fuse is burned or loosed. * Water level in sump has not reached turn-on level as indicated in installation drawing. * Pump cord is not making contact in receptacle. * Float is stuck. It should operate freely in basin. * If all of the above are OK, and then the motor winding can be re-start again.
Pump runs but does not deliver water.	<ul style="list-style-type: none"> * Check valve is installed backwards. Arrow on valve should point in direction of flow. * Discharge shut-off valve (if used) may be closed. * Impeller or volute openings are fully or partially clogged. Remove pump and clean. * Pump is air-locked. Start and stop several times by plugging and unplugging cord. Check for clogged vent hole in pump case. * Inlet holes in pump base are clogged. Remove pump and clean the openings. * Vertical pumping distance is too high. Reduce distance or change the discharge fittings of the pump.

1424664

<p>Pump runs and pumps out sump, but does not stop.</p>	<ul style="list-style-type: none"> * Float is stuck in up position. Be sure float operates freely in basin. * Defective float switch. Replace with float switch. * Defective vertical switch. Replace with vertical switch. * Pump is air-locked. Start and stop several times by plugging and unplugging cord. Check for clogged vent hole in pump case. * Vertical pumping distance is too high. Reduce distance or change the discharge fitting of the pump. Inlet holes in pump base are clogged. Remove pump and clean the openings. * Impeller or volute openings are fully or partially clogged. Remove pump and clean. * Pump impeller is partially clogged with tar or paint, causing motor to run slow and overload. Remove pump and clean.
<p>Fuse blows or circuit breaker trips when pump starts.</p>	<ul style="list-style-type: none"> * Pump impeller is partially clogged with tar or paint, causing motor to run slow and overload. Remove pump and clean. * Motor stator may be defective. * Fuse size or circuit breaker may be too small. (Must be 15 amps). * Impeller or volute opening are fully or partially clogged. Remove pump and clean.
<p>Motor runs for a short time, then stops.</p>	<ul style="list-style-type: none"> * Inlet holes in pump base are clogged. Remove pump and clean the openings. * Pump impeller is partially clogged with tar or paint, causing motor to run slow and overload. Remove pump and clean. * Motor stator may be defective. * Impeller or volute openings are fully or partially clogged. Remove pump and clean.



WARNING

ELECTRICAL PRECAUTIONS—

Be fore servicing a pump, always shut off the main power breaker and then unplug the pump. Make sure you are not standing in water and are wearing insulated protective sole shoes, under flooded conditions, Contact your local electric company or a qualified licensed electrician for disconnecting electrical service prior to pump removal.

STRUCTURE AND PARTS LIST

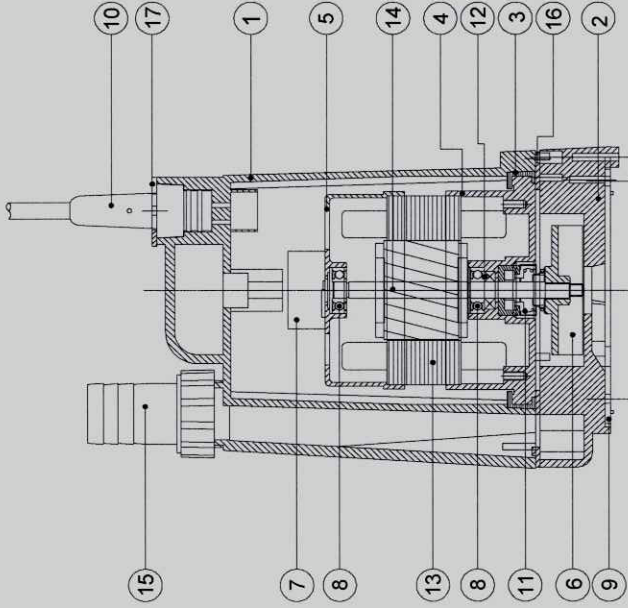

No.	Part Name	Materials
1	Motor Housing	PP+GF
2	Pump Casing	PP+GF
3	Pump Gasket	NBR
4	Lower bearing cover	ADC12
5	Upper bearing cover	ADC12
6	Impeller	PP+GF
7	Capacitor	6uF/350V
8	Bearing	NTN
9	Strainer	NYLON
10	Power cord	18AWG/3C
11	Mechical Seal	CA/CE
12	Oil Seal	NBR
13	Laminated plate	S.Steel Plate
14	Shaft	SUS
15	Discharge	PP
16	O-ring	NBR
17	C Gland	SUS

499/6257

Pump runs and pumps out sump, but does not stop.	<ul style="list-style-type: none"> * Float is stuck in up position. Be sure float operates freely in basin. * Defective float switch. Replace with float switch. * Defective vertical switch. Replace with vertical switch.
Pump runs but delivers only a small amount of water.	<ul style="list-style-type: none"> * Pump is air-locked. Start and stop several times by plugging and unplugging cord. Check for clogged vent hole in pump case. * Vertical pumping distance is too high. Reduce distance or change the discharge fitting of the pump. Inlet holes in pump base are clogged. Remove pump and clean the openings. * Impeller or volute openings are fully or partially clogged. Remove pump and clean. * Pump impeller is partially clogged with tar or paint, causing motor to run slow and overload. Remove pump and clean.
Fuse blows or circuit breaker trips when pump starts.	<ul style="list-style-type: none"> * Pump impeller is partially clogged with tar or paint, causing motor to run slow and overload. Remove pump and clean. * Motor stator may be defective. * Fuse size or circuit breaker may be too small. (Must be 15 amps). * Impeller or volute opening are fully or partially clogged. Remove pump and clean.
Motor runs for a short time, then stops.	<ul style="list-style-type: none"> * Inlet holes in pump base are clogged. Remove pump and clean the openings. * Pump impeller is partially clogged with tar or paint, causing motor to run slow and overload. Remove pump and clean. * Motor stator may be defective. * Impeller or volute openings are fully or partially clogged. Remove pump and clean.



ELECTRICAL PRECAUTIONS—

Be fore servicing a pump, always shut off the main power breaker and then unplug the pump. Make sure you are not standing in water and are wearing insulated protective sole shoes, under flooded conditions, Contact your local electric company or a qualified licensed electrician for disconnecting electrical service prior to pump removal.

STRUCTURE AND PARTS LIST

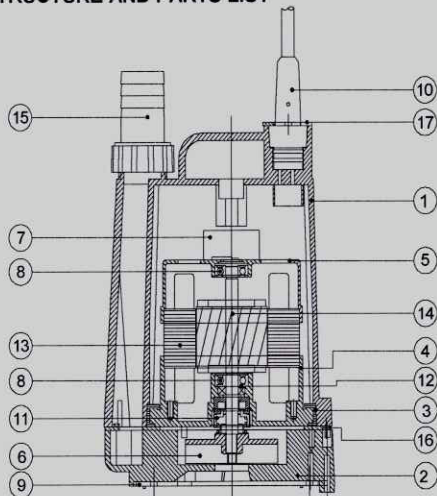

No.	Part Name	Materials
1	Motor Housing	PP+GF
2	Pump Casing	PP+GF
3	Pump Gasket	NBR
4	Lower bearing cover	ADC12
5	Upper bearing cover	ADC12
6	Impeller	PP+GF
7	Capacitor	6uF/350V
8	Bearing	NTN
9	Strainer	NYLON
10	Power cord	18AWG/3C
11	Mechical Seal	CA/CE
12	Oil Seal	NBR
13	Laminated plate	S.Steel Plate
14	Shaft	SUS
15	Discharge	PP
16	O-ring	NBR
17	C Gland	SUS



**OPERATION MANUAL
BPS-100 SERIES**

Dear Client,

Congratulations on your purchase of this pump products. Like all Arwana pumps products. We had developed with the help of the latest technologies and manufactured with the most advanced electrical/motor parts.

Please check the following point upon receipt of your pump:

- (1) Is the pump exactly what you ordered? Check the nameplate, please.
Is the frequency of the power supply correct? (50Hz or 60Hz power please check again)
- (2) Has any damage occurred during shipment? Are any bolts or nuts loose?

Take the time to read the instructions carefully before using this appliance.

We are strongly to recommend that you keep this instruction manual in a safe place for future reference.

Specifications

TYPE	OUTPUT		DISCHARGE		RATED		MAXIMUM		Dimension	Weight
	HP	W	mm	inch	head	capacity	head	capacity	(mm)	kg
					M	LPM	M	LPM	L x W x H	
BPS-100	1/6	100	25	1	4	35	6	70	155x155x240	2.9
BPS-100A	1/6	100	25	1	4	35	6	70	155x155x240	3.1
BPS-100V	1/6	100	25	1	4	35	6	70	155x155x240	3.1

Check the nameplate for your pump's specification as the table list.

Be careful not to exceed the given specifications in the use of your pump.

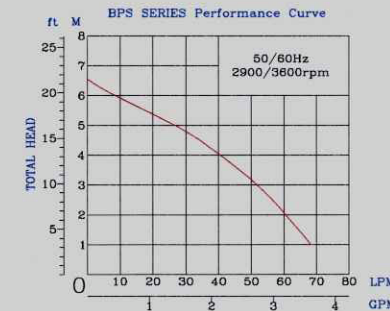

Marks and meaning:



DANGER Keep the pump equipment out of the reach of children!

DANGER Warns that the failure to follow the directions given could cause serious risk to individuals or objects.



WARNING This sign warns the operator that the failure to follow an instruction may damage the pump and/or the system.

WARNING This pump is designed for residential clean water "spot" jobs and cannot be used as a continuous duty sump pump or fountain pump.

Limitations:

This series pumps are suitable to pump water and be careful the water's suspension particles, it can't be over 4mm, or it will stock the bottom strainer.

The pump could be placed for sump pit that means it could pump fresh water of tunnel, route.

The fluid's temperature-limit is 40 centigrade(104 °F)high only, be careful not to pump hot water, otherwise it will damage the pump's life soon.



The pump cannot be used for sea water and inflammable, corrosive, explosive or dangerous liquids. Verify that the electro pump never runs without liquids.

Installation:

- Do not work on pump until power is unplugged.
- Do not cut off ground pin or use an adapter fitting.
- Do not use an extension cord.
- Do not handle the pump by the wire, that will cause the failure from the power cord when it run a long period time.
- Do not position the pump into a un-identify site which you don't know the Max. Diameter particles mixed with the water.



The pump power cord should be connected to a separately fused, grounded line with a minimum capacity of 15 amps. It can be connect to non- fuse breaker as the recommended amperes. Never touch the pump when it is connected to electrical power.

1. Before installing or servicing this pump, be certain pump power source is disconnected.
2. Installation and electrical wiring must adhere to state and local codes and must be completed before priming pump. Check appropriate community agencies, or contact local electrical and pump professionals.
3. Call an electrician when in doubt. Pump should be connected to a separate 15 amps circuit breaker or 15 amps fuse block. Note that, plugging into existing outlets may cause low voltage at motor, causing blown fuses, tripping of motor overload, or burned out motor.
4. A permanent ground connection from pump to the grounding bar at the service panel is mandatory. ARWANA sump pumps come with a grounding conductor and a grounding-type attachment plug. Do not connect pump to a power supply until permanently grounded. For maximum safety, ground pump to a circuit equipped with a fault interrupter device.
5. Voltage of power supply must match the voltage of the pump.
6. Before installing pump, clear sump basin of any water, debris, or sediment. Warning: Sump basin must be vented in accordance with local plumbing codes. ARWANA Sump pumps are not designed for and CANNOT be installed in locations classified as hazardous.
7. The following may cause severe damage to pump and will void warranty:
 - (a) Using an extension cord.
 - (b) Cutting off the ground pin or using an adapter fitting.
 - (c) Working on pump or switch while plugged in.
 - (d) Removing motor housing, unscrewing impeller, or otherwise removing impeller seal
 - (e) Pumping chemicals or corrosive liquids.
 - (f) Pumping gasoline or other flammable liquids.
 - (g) Pumping hot liquids. (exceed 40 centigrade)(over 104 °F)



When the pump reach to an overheat level, it will shut-off automatically, once it cooled down either naturally or by being submerged in a bucket of cold water (5+ gallons for 20 minutes more). The pump will reset and can ready to pump again.

- 8.The simple way to connect this ARWANA Utility Pump
 - STEP 1: Connect a standard garden hose to the utility pump threaded discharge.
 - STEP 2: Place the utility pump into the water to be pumped.
 - STEP 3: Move away from the area to be pumped, and while standing on dry and grounded outlet.

Electrical wire Connection:



Verify that the voltage and frequency of the electro pump shown on the nameplate correspond to those available on the mains. The installer must make sure that the electric system is grounded in accordance with the law in force.

It is necessary to use cable with a length of 10m for outdoors using. The plug and connections should be protected from water splashes. Before using the pump, always inspect it visually (especially power cable and plug). Do not use the pump if it is damaged.

If the pump is damaged, have it inspected by the specialized assistance service only. Make sure that electric connections are protected from inundation. Protect the plug and the power cable from heat, oil or the power cable must be replaced by qualified personnel only.



Grounding: The plug of the power cable has a double grounding contact, so that grounding can be performed by simply inserting the plug.

Overload protection:

This series pump have a built in thermal protection switch. The pump stops if an overload condition occurs. The motor restarts automatically after it has cooled down when the built in thermal protector works.

Limited Warranty

ARWANA PUMP will repair or replace for the original user any portion of a new ARWANA PUMP product which prove defective due to materials or workmanship of ARWANA PUMP. Contact the nearest authorized ARWANA PUMP dealer for warranty service.

ARWANA PUMP shall possess the sole right to determine whether to repair or replace defective equipment, parts or components.

THIS WARRANTY DOES NOT COVER DAMAGE DUE TO LIGHTING OR OTHER CONDITIONS BEYOND THE CONTROL OF ARWANA PUMP .

PUMPS: Warranted 12 months from date of purchase or 15 months from the date of manufacture. Receipt and product date code required for warranty claim.

LABOR & COSTS: ARWANA PUMP shall in no event be liable for the cost of field labor to other charges incurred by any customer in removing and/or reaffixing any ARWANA PUMP product, parts or component.

THE WARRANTY WILL NOT APPLY:

- (a) to defects or malfunctions resulting from failure to properly install, operate, or maintain the unit in accordance with printed instructions provided.
- (b) to failures resulting from abuse, accident, or negligence.
- (c) to normal maintenance services and the parts used in connection with such service.
- (d) to units which are not installed in accordance with applicable local codes, ordinances, and good trade practices.
- (e) if the unit is moved from its original installation location.
- (f) if unit is used for purposes other than for what it was designed and manufactured for.

WARRANTY EXCLUSIONS: ARWANA PUMP

SPECIFICALLY DISCLAIMS THE IMPLIED WARRANTIES OF MERCHANTABILITY AND FITNESS FOR A PARTICULAR PURPOSE AFTER THE TERMINATION OF THE WARRANTY PERIOD.

Guarantee

The right to claim under guarantee must be proven by the purchaser by presentation of the purchase invoice.

Note:

1. Should your equipment not function correctly, please firstly check, whether other reasons, e.g. interruption of the power supply, or incorrect handling are the cause.
2. Please note that it is imperative that the following documents and details are produced together with your faulty equipment:
 - (a) Purchase receipt
 - (b) Designation of the apparatus/type/brand
 - (c) Description of the noted defect (an accurate description of the defect makes a rapid repair easier for us)

In the case of a claim for guarantee or defects, please contact the place of purchase.

TROUBLESHOOTING CHECKLIST (CAUTION: SHUT OFF POWER TO PUMP)

PROBLEMS	POSSIBLE CAUSES
Pump does not run and hums	<ul style="list-style-type: none"> * Line circuit breaker is off, or fuse is burned or loosed. * Water level in sump has not reached turn-on level as indicated in installation drawing. * Pump cord is not making contact in receptacle. * Float is stuck. It should operate freely in basin. * If all of the above are OK, and then the motor winding can be re-start again.
Pump runs but does not deliver water.	<ul style="list-style-type: none"> * Check valve is installed backwards. * Arrow on valve should point in direction of flow. * Discharge shut-off valve (if used) may be closed. * Impeller or volute openings are fully or partially clogged. Remove pump and clean. * Pump is air-locked. Start and stop several times by plugging and unplugging cord. Check for clogged vent hole in pump case. * Inlet holes in pump base are clogged. Remove pump and clean the openings. * Vertical pumping distance is too high. Reduce distance or change the discharge fittings of the pump.

1474 424 799