

CIGWELD

Manual Metal Arc Welder

Operating Manual

Compact

620465

Compact Turbo

620466

Easywelder Turbo

620467

Issue 1

February, 2000

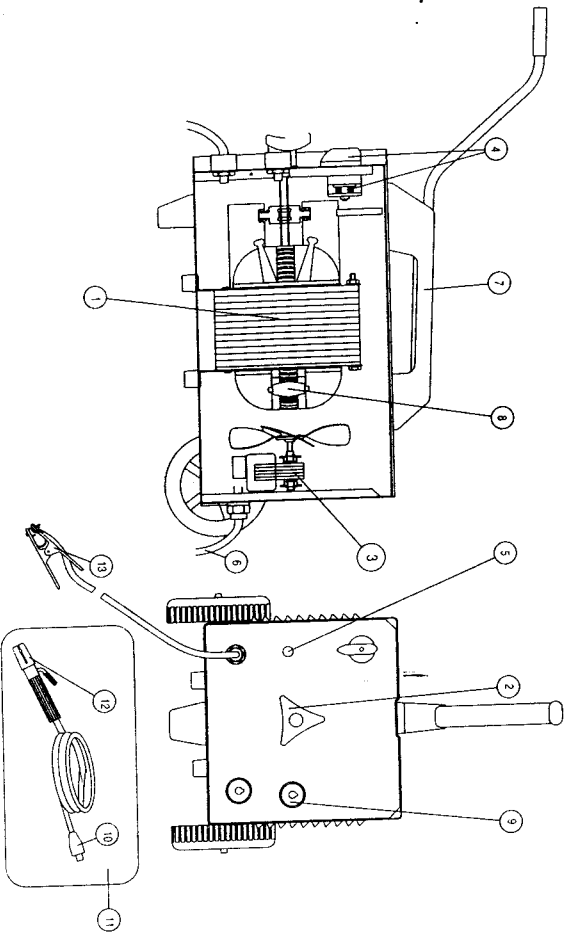

15.5 Wiring Diagrams

Compact

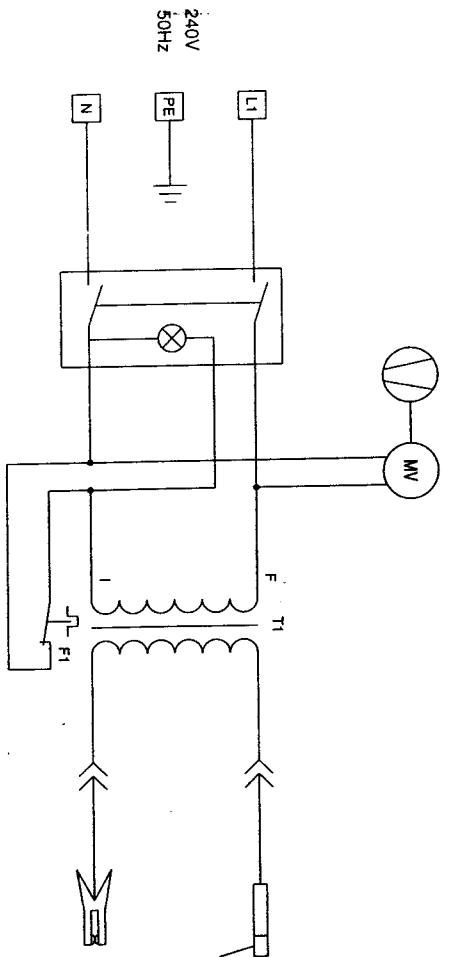
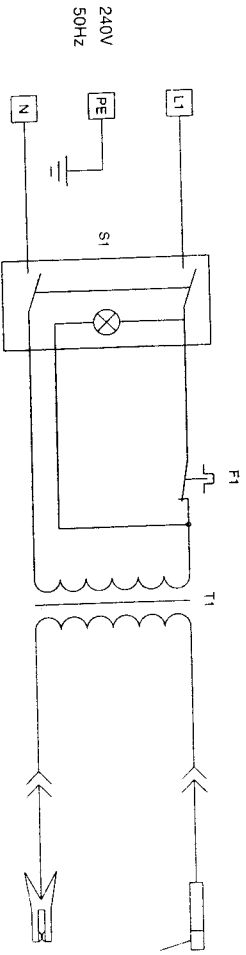

Easywelder Turbo

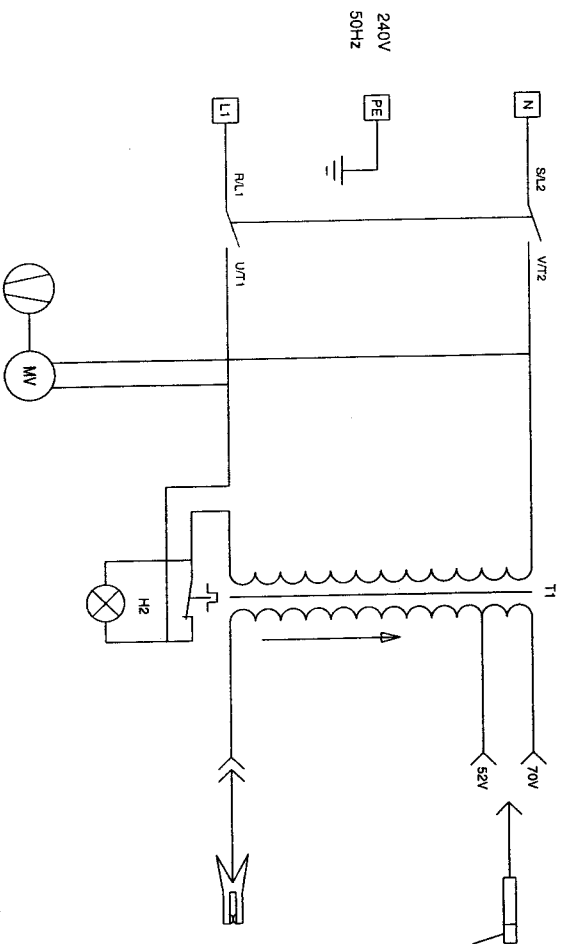



CIGWELD advises that any electrical component should be fitted by a qualified electrical tradesperson.

Description	Compact Spares	Compact Turbo Spares	Easywelder Turbo Spares
1 Transformer assembly	620468	620471	620473
2 Current Control Knob/ Assembly	620469	620469	620476
3 Fan Motor c/w blade	—	620472	620472
4 Main Switch	620470	620470	620474
5 Overload light	—	—	620475
6 Mains Supply Cable (See CAUTION 4)	620291	620291	VB1358
7 Handle	620477	620477	620477
8 Thermostat 40A.	620478	620478	620478
9 Socket 25mm ²	—	—	7977159
10 Electrode Lead Plug	—	—	705152
11 Electrode & Work Leads	—	—	646323
12 Electrode Holder	646165	646165	646165
13 Work Clamp	KP301	KP301	KP301
14 Face shield	454055	454055	454055
15 Wire Brush	646364	646364	646364
16 Chipping Hammer	646215	646215	646215

CAUTION 4

If the 240V supply cable is damaged it must be replaced with a CIGWELD genuine spare part either by an accredited Arc Equipment CIGWELD Service Agent or by a similarly qualified person so as to avoid a hazard.

Compact

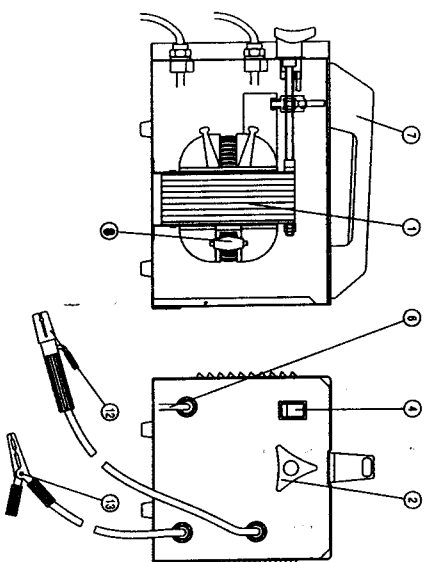

Compact Turbo

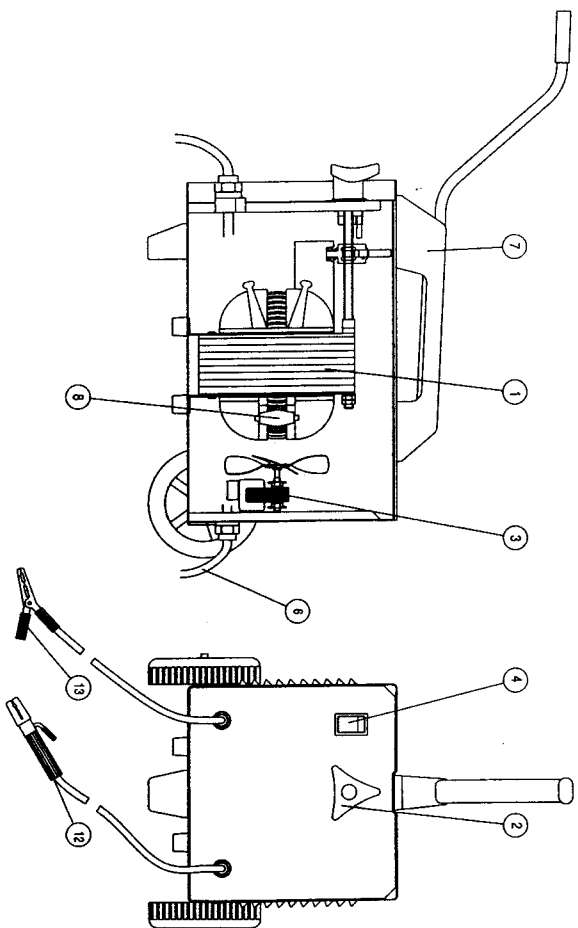

FAULT	CAUSE	REMEDY
5 A groove has been formed in the base metal adjacent to the toe of a weld and has not been filled by the weld metal (undercut).	A Welding current is too high. B Welding arc is too long. C Angle of the electrode is incorrect. D Joint preparation does not allow correct electrode angle. E Electrode too large for joint. F Insufficient deposit time at edge of weave.	A Reduce welding current. B Reduce the length of the welding arc. Electrode should not be inclined less than 45° to the vertical face. C Allow more room in joint for manipulation of the electrode. D Use smaller gauge electrode. E Pause for a moment at edge of weave to allow weld metal build-up.

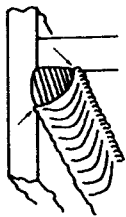
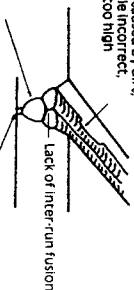

Figure 32 - Examples of undercut

Welding Problems (continued)

FAULT	CAUSE	REMEDY
6 Portions of the weld run do not fuse to the surface of the metal or edge of the joint.	A Small electrodes used on heavy cold plate. B Welding current is too low. C Wrong electrode angle. D Travel speed of electrode is too high. E Scale or dirt on joint surface.	A Use larger electrodes and pre-heat the plate. B Increase welding current. C Adjust angle so the welding arc is directed more into the base metal. D Reduce travel speed of electrode. E Clean surface before welding.



Lack of fusion caused by dirt, electrode angle incorrect, rate of travel too high

Lack of side fusion, scale dirt, small electrode, amperage too low

Figure 33 - Example of lack of fusion

15.2 Welding Power Source Problems

FAULT	CAUSE	REMEDY
1 The welding arc cannot be established. The overload light is not illuminated.	A The Mains supply voltage has not been switched ON. B The Welding Power Source switch is switched OFF. C Loose primary connection to the electrode selection switch. D The transformer secondary have poor electrical connections.	A Switch ON the Mains supply voltage. B Switch ON the Welding Power Source. C Have an Accredited CIGWELD Service Agent repair the connection. D Have an Accredited CIGWELD Service Agent repair the transformer.
2 The Mains supply voltage is ON, the overload light is illuminated and the welding arc cannot be established.	The Welding Power Source's duty cycle has been exceeded.	Wait for the overload light to extinguish before resuming your arc welding
3 The Mains supply voltage is ON, the overload light is illuminated, the Welder has not been used for more than one hour and the welding arc cannot be established.	The Welding Power Source's thermostat has malfunctioned.	Have an Accredited CIGWELD Service Agent repair or replace the thermostat.
4 Maximum output welding current can not be achieved with 240V Mains supply voltage.	The shunt and/or lead screw surfaces have accumulated dust and dirt.	Clean off the accumulated dust and dirt from the shunt and/or lead screw surfaces.
5 The Mains supply voltage has been switched ON but the FAN does not operate.	A Compact Turbo & Easywelder Turbo Models The fan has failed or it has a poor electrical connection.	A Compact Turbo & Easywelder Turbo Models Have an Accredited CIGWELD Service Agent repair or replace the fan.
6 Welding current reduces when welding	B Compact Model This Welding Power Source is not fitted with a fan. Poor work lead connection to the work piece.	B Compact Model This Welding Power Source is not fitted with a fan. Ensure that the work lead has a positive electrical connection to the work piece.

14. ROUTINE MAINTENANCE & INSPECTION



WARNING 5

There are extremely dangerous voltage and power levels present inside this product. Do not attempt to open or repair unless you are a qualified electrical tradesperson. Disconnect the Welding Power Source from the Mains Supply Voltage before disassembling.

Welding equipment should be regularly checked by a qualified electrical tradesperson to ensure that:

- The main earth wire of the electrical installation is intact.
- Power point for the Welding Power Source is effectively earthed and of adequate current rating.
- Plugs and cord extension sockets are correctly wired.
- Flexible cord is of the 3-core tough rubber or plastic sheathed type of adequate rating, correctly connected and in good condition.
- Welding terminals are shrouded to prevent inadvertent contact or short circuit.
- The frame of the Welding Power Source is effectively earthed.
- Welding leads and electrode holder are in good condition.
- The Welding Power Source is clean internally, especially from metal filings, slag, and loose material. If any parts are damaged for any reason, replacement is recommended.

14.1 Cleaning the Welding Power Source

Refer to **WARNING 5**. To clean the Welding Power Source, open the enclosure and use a vacuum cleaner to remove any accumulated dirt, metal filings, slag and loose material. Keep the shunt and lead screw surfaces clean as accumulated foreign material may reduce the welders output welding current.

CAUTION 3

Do not use compressed air to clean the Welding Power Source. Compressed air can force metal particles to lodge between live electrical parts and earthed metal parts within the Welding Power Source. This may result in arcing between these parts and their eventual failure.

14.2 Face Shield Maintenance

The face shield and lens should be cleaned after use with a soft cloth.

15. BASIC TROUBLESHOOTING



WARNING 6

There are extremely dangerous voltage and power levels present inside this product. Do not attempt to open or repair unless you are a qualified electrical tradesperson and you have had training in power measurements and troubleshooting techniques.

If major complex subassemblies are faulty, then the Welding Power Source must be returned to an Accredited CIGWELD Service Agent for repair.

The basic level of troubleshooting is that which can be performed without special equipment or knowledge.

15.1 Welding Problems

FAULT	CAUSE	REMEDY
1 Gas pockets or voids in weld metal (Porosity).	A Electrodes are damp. B Welding current is too high. C Surface impurities such as oil, grease, paint, etc.	A Dry electrodes before use. B Reduce welding current. C Clean joint before welding.
2 Crack occurring in weld metal soon after solidification commences	A Rigidity of joint. B Insufficient throat thickness. C Cooling rate is too high.	A Redesign to relieve weld joint of severe stresses or use crack resistance electrodes. B Travel slightly slower to allow greater build up in throat. C Preheat plate and cool slowly.
3 A gap is left by failure of the weld metal to fill the root of the weld.	A Welding current is too low. B Electrode too large for joint. C Insufficient gap. D Incorrect sequence.	A Increase welding current B Use smaller diameter electrode. C Allow wider gap. D Use correct build-up sequence.

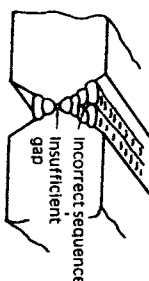

Figure 31 - Example of insufficient gap or incorrect sequence

Welding Problems (continued)

FAULT	CAUSE	REMEDY
4 Non-metallic particles are trapped in the weld metal (slag inclusion).	A Non-metallic particles may be trapped in undercut from previous run. B Joint preparation too restricted. C Irregular deposits allow slag to be trapped. D Lack of penetration with slag trapped beneath weld bead. E Rust or mill scale is preventing full fusion. F Wrong electrode for position in which welding is done.	A If bad undercut is present, clean slag out and cover with a run from a smaller diameter electrode. B Allow for adequate penetration and room for cleaning out the slag. C If very bad, chip or grind out irregularities. D Use smaller electrode with sufficient current to give adequate penetration. Use suitable tools to remove all slag from corners. E Clean joint before welding. F Use electrodes designed for position in which welding is done, otherwise proper control of slag is difficult.

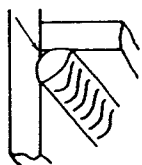
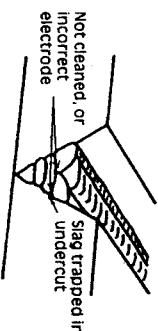

Figure 31 - Examples of slag inclusion

b) Expansion and Contraction of Parent Metal in the Fusion Zone:

While welding is proceeding, a relatively small volume of the adjacent plate material is heated to a very high temperature and attempts to expand in all directions. It is able to do this freely at right angles to the surface of the plate (i.e., "through the weld"), but when it attempts to expand "across the weld" or "along the weld", it meets considerable resistance, and to fulfill the desire for continued expansion, it has to deform plastically, that is, the metal adjacent to the weld is at a high temperature and hence rather soft, and, by expanding, pushes against the cooler, harder metal further away, and tends to bulge (or is "upset"). When the weld area begins to cool, the "upset" metal attempts to contract as much as it expanded, but, because it has been "upset", it does not resume its former shape, and the contraction of the new shape exerts a strong pull on adjacent metal. Several things can then happen.

The metal in the weld area is stretched (plastic deformation), the job may be pulled out of shape by the powerful contraction stresses (distortion), or the weld may crack, in any case, there will remain "locked-up" stresses in the job. Figure 22 and Figure 23 illustrate how distortion is created.

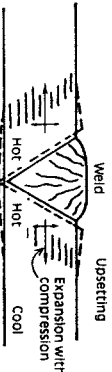

Figure 22 - Parent metal expansion

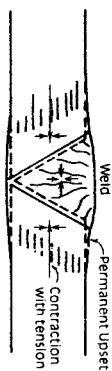

Figure 23 - Parent metal contraction

13.2 Overcoming Distortion Effects

There are several methods of minimizing distortion effects.

a) Peening:

This is done by hammering the weld while it is still hot. The weld metal is flattened slightly and because of this the tensile stresses are reduced a little. The effect of peening is relatively shallow, and is not advisable on the last layer.

b) Distribution of Stresses:

Distortion may be reduced by selecting a welding sequence which will distribute the stresses suitably so that they tend to cancel each other out. See Figure 27 to Figure 30 for various weld sequences. Choice of a suitable weld sequence is probably the most effective method of overcoming distortion, although an unsuitable sequence may exaggerate it. Simultaneous welding of both sides of a joint by two welders is often successful in eliminating distortion.

c) Restraint of Parts:

Forcible restraint of the components being welded is often used to prevent distortion. Jigs, positions, and tack welds are methods employed with this in view.

d) Presetting:

It is possible in some cases to tell from past experience or to find by trial and error (or less frequently, to calculate) how much distortion will take place in a given welded structure. By correct pre-setting of the components to be welded, constructional stresses can be made to pull the parts into correct alignment. A simple example is shown in Figure 24.

e) Preheating:

Suitable preheating of parts of the structure other than the area to be welded can be sometimes used to reduce distortion. Figure 25 shows a simple application. By removing the heating source from *b* and *c* as soon as welding is completed, the sections *b* and *c* will contract at a similar rate, thus reducing distortion.



Figure 24 - Principle of presetting

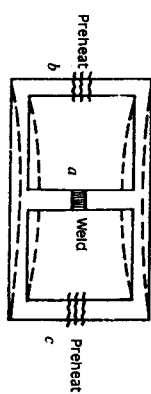

Figure 25 - Reduction of distortion by preheating

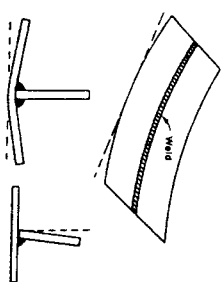

Figure 26 - Examples of distortion

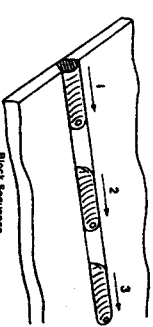

Figure 27 - Welding sequence

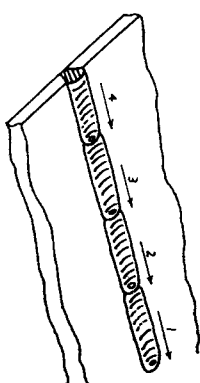

Figure 28 - Step back sequence

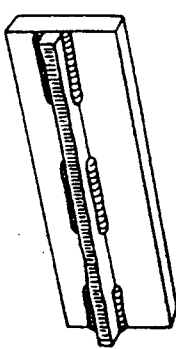

Figure 29 - Chain intermittent welding

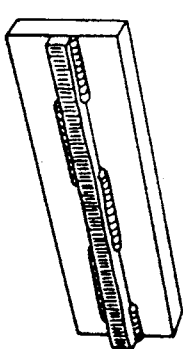

Figure 30 - Staggered intermittent welding

b) Fillet Welds

These are welds of approximately triangular cross-section made by depositing metal in the corner of two faces meeting at right angles. Refer to Figure 7.

A piece of angle iron is a suitable specimen with which to begin, or two lengths of strip steel may be tacked together at right angles. Using a 3.2mm Ferrocraft 21 electrode at 100 amps, position angle iron with one leg horizontal and the other vertical. This is known as a horizontal-vertical (HV) fillet. Strike the arc and immediately bring the electrode to a position perpendicular to the line of the fillet and about 45° from the vertical. Some electrodes require to be sloped about 20° away from the perpendicular position to prevent slag from running ahead of the weld. Refer to Figure 16. Do not attempt to build up much larger than 6.4mm width with a 3.2mm electrode, otherwise the weld metal tends to sag towards the base, and undercut forms on the vertical leg. Multi-runs can be made as shown in Figure 17. Weaving in HV fillet welds is undesirable.

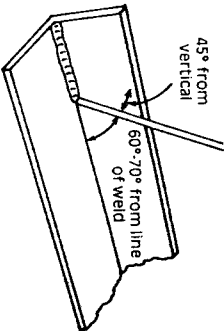

Figure 16 - Electrode position for HV fillet weld

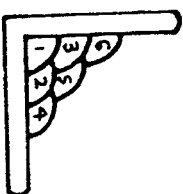

Figure 17 - Multi-runs in HV fillet weld

c) Vertical Welds

i) Vertical Up

Tack weld a three feet length of angle iron to your work bench in an upright position. Use a 3.2mm Ferrocraft 21 electrode and set the current at 100 amps. Make yourself comfortable on a seat in front of the job and strike the arc in the corner of the fillet. The electrode needs to be about 10° from the horizontal to enable a good bead to be deposited. Refer Figure 18. Use a short arc, and do not attempt to weave on the first run. When the first run has been completed deslag the weld deposit and begin the second run at the bottom. This time a slight weaving motion is necessary to cover the first run and obtain good fusion at the edges. At the completion of each side motion, pause for a moment to allow weld metal to build up at the edges, otherwise undercut will form and too much metal will accumulate in the centre of the weld. Figure 19 illustrates multi-run technique and Figure 20 shows the effects of pausing at the edge of weave and of weaving too rapidly.

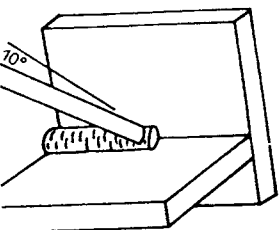

Figure 18 - Single run vertical fillet weld

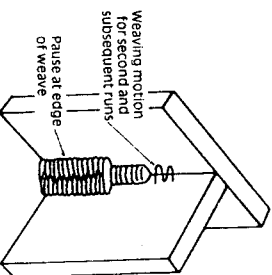
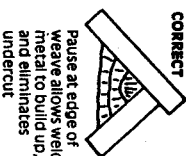

Figure 19 - Multi run vertical fillet weld

ii) Vertical Down

The Ferrocraft 21 electrode makes welding in this position particularly easy. Use a 3.2mm electrode at 100 amps. The tip of the electrode is held in light contact with the work and the speed of downward travel is regulated so that the tip of the electrode just keeps ahead of the slag. The electrode should point upwards at an angle of about 45°



CORRECT

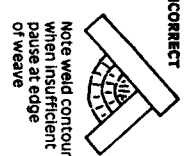

INCORRECT

Figure 20 - Examples of vertical fillet welds

iii) Overhead Welds

Apart from the rather awkward position necessary, overhead welding is not much more difficult than downhand welding. Set up a specimen for overhead welding by first tacking a length of angle iron at right angles to another piece of angle iron or a length of waste pipe. Then tack this to the work bench or hold in a vice so that the specimen is positioned in the overhead position as shown in the sketch. The electrode is held at 45° to the horizontal and tilted 10° in the line of travel (Figure 21). The tip of the electrode may be touched lightly on the metal, which helps to give a steady run. A weave technique is not advisable for overhead fillet welds. Use a 3.2mm Ferrocraft 12XP electrode at 100 amps, and deposit the first run by simply drawing the electrode along at a steady rate. You will notice that the weld deposit is rather convex, due to the effect of gravity before the metal freezes.

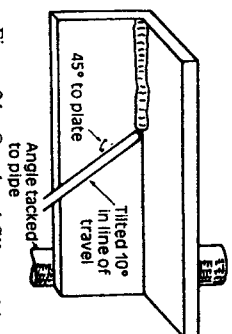

Figure 21 - Overhead fillet weld

13. DISTORTION

Distortion in some degree is present in all forms of welding. In many cases it is so small that it is barely perceptible, but in other cases allowance has to be made before welding commences for the distortion that will subsequently occur. The study of distortion is so complex that only a brief outline can be attempted here.

13.1 The Cause of Distortion

Distortion is caused by:

a) Contraction of Weld Metal:

Molten steel shrinks approximately 11 per cent in volume on cooling to room temperature. This means that a cube of molten metal would contract approximately 2.2 per cent in each of its three dimensions. In a welded joint, the metal becomes attached to the side of the joint and cannot contract freely. Therefore, cooling causes the weld metal to flow plastically, that is, the weld itself has to stretch if it is to overcome the effect of shrinking volume and still be attached to the edge of the joint. If the restraint is very great, as, for example, in a heavy section of plate, the weld metal may crack. Even in cases where the weld metal does not crack, there will still remain stresses "locked-up" in the structure. If the joint material is relatively weak, for example, a butt joint in 2.0mm sheet, the contracting weld metal may cause the sheet to become distorted.

12. ARC WELDING TECHNIQUE**12.1 A Word to Beginners**

For those who have not yet done any welding, the simplest way to commence is to run beads on a piece of scrap plate. Use mild steel plate about 6.0mm thick and a 3.2mm electrode. Clean any paint, loose scale or grease off the plate and set it firmly on the work bench so that welding can be carried out in the downhand position. Make sure that the work clamp is making good electrical contact with the work, either directly or through the work table. For light gauge material, always clamp the work lead directly to the job, otherwise a poor circuit will probably result.

12.2 The Welder

Place yourself in a comfortable position before beginning to weld. Get a seat of suitable height and do as much work as possible sitting down. Don't hold your body tense. A taut attitude of mind and a tensed body will soon make you feel tired. Relax and you will find that the job becomes much easier. You can add much to your peace of mind by wearing a leather apron and gauntlets. You won't be worrying then about being burnt or sparks setting alight to your clothes.

Place the work so that the direction of welding is across, rather than to or from, your body. The electrode holder lead should be clear of any obstruction so that you can move your arm freely along as the electrode burns down. If the lead is slung over your shoulder, it allows greater freedom of movement and takes a lot of weight off your hand. Be sure the insulation on your cable and electrode holder is not faulty, otherwise you are risking an electric shock.

12.3 Striking the Arc

Practice this on a piece of scrap plate before going on to more exacting work. You may at first experience difficulty due to the tip of the electrode "sticking" to the work piece. This is caused by making too heavy a contact with the work and failing to withdraw the electrode quickly enough. A low amperage will accentuate it. This freezing-on of the tip may be overcome by **scratching the electrode along the plate surface in the same way as a match is struck**. As soon as the arc is established, maintain a 1.6mm to 3.2mm gap between the burning electrode end and the parent metal. Draw the electrode slowly along as it melts down.

Another difficulty you may meet is the tendency, after the arc is struck, to withdraw the electrode so far that the arc is broken again. A little practice will soon remedy both of these faults.

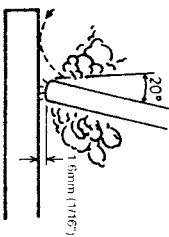

Figure 13 - Striking an arc

12.4 Arc Length

The securing of an arc length necessary to produce a neat weld soon becomes almost automatic. You will find that a long arc produces more heat. A very long arc produces a cracking or spluttering noise and the weld metal comes across in large, irregular blobs. The weld bead is flattened and spatter increases. A short arc is essential if a high quality weld is to be obtained although if it is too short there is the danger of it being blanketed by slag and the electrode tip being solidified in. If this should happen, give the electrode a quick twist back over the weld to detach it. Contact or "touch-weld" electrodes such as Ferrocraft 21 do not stick in this way, and make welding much easier.

12.5 Rate of Travel

After the arc is struck, your next concern is to maintain it, and this requires moving the electrode tip towards the molten pool at the same rate as it is melting away. At the same time, the electrode has to move along the plate to form a bead. The electrode is directed at the weld pool at about 20° from the vertical. The rate of travel has to be adjusted so that a well-formed bead is produced.

If the travel is too fast, the bead will be narrow and strung out and may even be broken up into individual globules. If the travel is too slow, the weld metal piles up and the bead will be too large.

12.6 Making Welded Joints

Having attained some skill in the handling of an electrode, you will be ready to go on to make up welded joints.

a) Butt Welds

Set up two plates with their edges parallel, as shown in Figure 14, allowing 1.6mm to 2.4mm gap between them and tack weld at both ends. This is to prevent contraction stresses from the cooling weld metal pulling the plates out of alignment. Plates thicker than 6.0mm should have their mating edges bevelled to form a 70° to 90° included angle. This allows full penetration of the weld metal to the root. Using a 3.2mm Ferrocraft 21 electrode at 100 amps, deposit a run of weld metal on the bottom of the joint.

Do not weave the electrode, but maintain a steady rate of travel along the joint sufficient to produce a well-formed bead. At first you may notice a tendency for undercut to form, but keeping the arc length short, the angle of the electrode at about 20° from vertical, and the rate of travel not too fast, will help eliminate this. The electrode needs to be moved along fast enough to prevent the slag pool from getting ahead of the arc. To complete the joint in thin plate, turn the job over, clean the slag out of the back and deposit a similar weld.

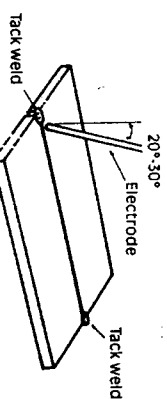

Figure 14 - Butt weld

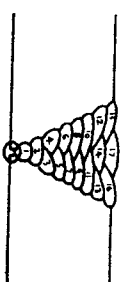

Figure 15 - Weld build up sequence

Heavy plate will require several runs to complete the joint. After completing the first run, chip the slag out and clean the weld with a wire brush. It is important to do this to prevent slag being trapped by the second run. Subsequent runs are then deposited using either a weave technique or single beads laid down in the sequence shown in Figure 15. The width of weave should not be more than three times the core wire diameter of the electrode. When the joint is completely filled, the back is either machined, ground or gouged out to remove slag which may be trapped in the root, and to prepare a suitable joint for depositing the backing run. If a backing bar is used, it is not usually necessary to remove this, since it serves a similar purpose to the backing run in securing proper fusion at the root of the weld.

c) Cast Iron

Most types of cast iron, except white iron, are weldable. White iron, because of its extreme brittleness, generally cracks when attempts are made to weld it. Trouble may also be experienced when welding white-heart malleable, due to the porosity caused by gas held in this type of iron.

d) Copper and alloys

The most important factor is the high rate of heat conductivity of copper, making preheating of heavy sections necessary to give proper fusion of weld and base metal.

11. ARC WELDING PRACTICE

The techniques used for arc welding are almost identical regardless of what types of metals are being joined. Naturally enough, different types of electrodes would be used for different metals as described in the preceding section.

11.1 Welding Position

The electrodes dealt with in this publication can be used in most positions, i.e. they are suitable for welding in flat, horizontal, vertical and overhead positions. Numerous applications call for welds to be made in positions intermediate between these. Some of the common types of welds are shown in Figure 4 to Figure 11.



Figure 4 - Flat position, down hand butt weld

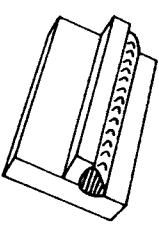

Figure 5 - Flat position, gravity fillet weld

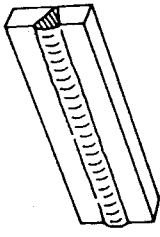

Figure 6 - Horizontal position, butt weld

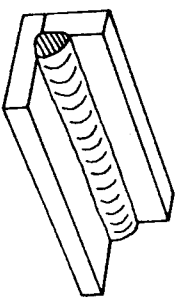

Figure 7 - Horizontal - Vertical (HV) position

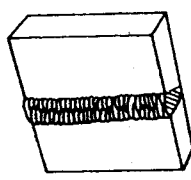

Figure 8 - Vertical position, butt weld

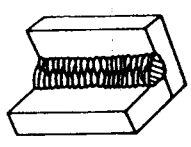

Figure 9 - Vertical position, fillet weld



Figure 10 - Overhead position, butt weld

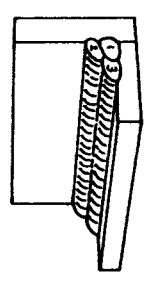

Figure 11 - Overhead position fillet, weld

11.2 Joint Preparations

In many cases, it will be possible to weld steel sections without any special preparation. For heavier sections and for repair work on castings, etc., it will be necessary to cut or grind an angle between the pieces being joined to ensure proper penetration of the weld metal and to produce sound joints.

In general, surfaces being welded should be clean and free of rust, scale, dirt, grease, etc. Slag should be removed from oxy-cut surfaces. Typical joint designs are shown in Figure 12.

Open Square Butt Joint

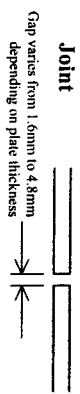

Single Vee Butt Joint



Single Vee Butt Joint

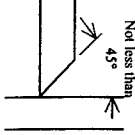

Double Vee Butt Joint

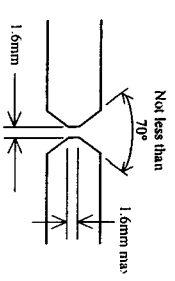

Lap Joint



Filler Joint



Corner Weld

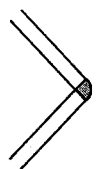

Tee Joints (Filler both sides of the joint)

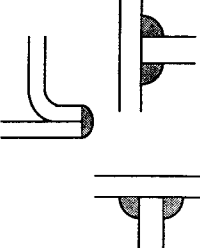

Edge Joint

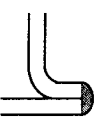

Plug Weld



Plug Weld

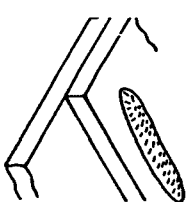
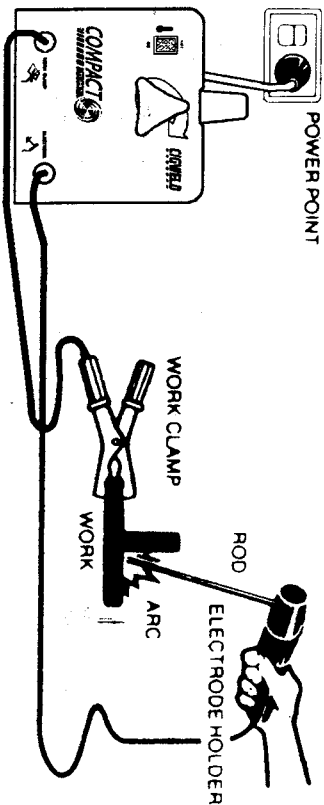

Figure 12 - Typical joint designs for arc welding



10. ARC WELDING ELECTRODES

Metal arc welding electrodes consist of a core wire surrounded by a flux coating. The flux coating is applied to the core wire by an extrusion process.

The coating on arc welding electrodes serves a number of purposes:

- a) To provide a gaseous shield for the weld metal, and preserve it from contamination by the atmosphere whilst in a molten state.
- b) To give a steady arc by having 'arc stabilisers' present, which provide a bridge for current to flow across.
- c) To remove oxygen from the weld metal with 'deoxidisers'.
- d) To provide a cleansing action on the work piece and a protective slag cover over the weld metal to prevent the formation of oxides while the metal is solidifying. The slag also helps to produce a bead of the desired contour.
- e) To introduce alloys into the weld deposits in special type electrodes.

10.2 Types of Electrodes

Arc Welding electrodes are classified into a number of groups depending on their applications. There are a great number of electrodes used for specialised industrial purposes which are not of particular interest for everyday general work. These include some low hydrogen types for high tensile steel, cellulose types for welding large diameter pipes, etc.

The range of electrodes dealt with in this publication will cover the vast majority of applications likely to be encountered; are all easy to use and all will work on even the most basic of welding machines.

Metals being joined	CIGWELD Electrode	Comments
Mild steel	Saincraft 13 (AS/NZS E4113-0)	Ideal electrodes for all general purpose work. Features include out standing operator appeal, easy arc starting and low spatter.
Mild steel	Ferrocrafit 21 (AS/NZS E4818-2)	All positional electrode for use on mild and galvanised steel furniture, plates, fences, gates, pipes and tanks etc. Especially suitable for vertical-down welding.
Cast iron	Castercraft 100	Suitable for joining all cast irons except white cast iron.

Metals being joined	CIGWELD Electrode	Comments
Stainless steel	Saincrome 318-16 (AS/NZS E316L-17)	High corrosion resistance. Ideal for dairy work, etc. On stainless steels.
Copper, Bronze, Brass, etc.	Bronzcraft (AS/NZS E6200-A2)	Easy to use electrode for marine fittings, water taps and valves, water trough float arms, etc. Also for joining copper to steel and for bronze overlays on steel shafts.
High alloy steels, Dissimilar metals, Crack resistance, All hard-to-weld jobs.	Weldall (AS/NZS E312-17)	Weldall does truly what its name states. It will weld even the most problematical jobs such as springs, shafts, broken joints mild steel to stainless and alloy steels. Not suitable for Aluminium.

Table 2 - Types of Electrodes

For **HARDFACING** of Steels, **CIGWELD TOOLCRAFT** is an electrode which produces an extremely hard weld deposit. It is ideal for building up axes, wedges, slasher blades, worn cams, rock drills, earth moving and digging equipment, etc.

10.3 Size of Electrode

The electrode size is determined by the thickness of metals being joined and can also be governed by the type of welding machine available. Small welding machines will only provide sufficient current (amperage) to run the smaller size electrodes.

For most work, a 3.2mm electrode will be quite sufficient. A 3mm electrode will give just as strong a joint but may require a few more weld runs to be put down to fill the joint.

For thin sections, it is necessary to use smaller electrodes otherwise the arc may burn holes through the job. A little practice will soon establish the most suitable electrode for a given application.

10.4 Storage of Electrodes

Always store electrodes in a dry place and in their original containers.

10.5 Electrode Polarity

Electrodes are generally connected to the **ELECTRODE HOLDER** and the **WORK LEAD** to the work piece but if in doubt consult your nearest accredited CIGWELD Distributor.

10.6 Effects of Arc Welding Various Materials

- a) High tensile and alloy steels

The two most prominent effects of welding these steels are the formation of a hardened zone in the weld area, and, if suitable precautions are not taken, the occurrence in this zone of under-bead cracks may result. Hardened zone and under-bead cracks in the weld area may be reduced by using the correct electrodes, preheating, using higher current settings, using larger electrode sizes, short runs for larger electrode deposits or tempering in a furnace.

- b) Austenitic manganese steels

The effect on manganese steel of slow cooling from high temperatures is to embrittle it. For this reason it is absolutely essential to keep manganese steel cool during welding by quenching after each weld or skip welding to distribute the heat.

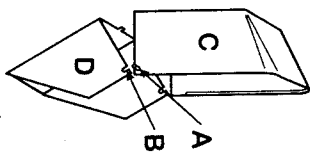

Figure 1 - Hook face shield halves together

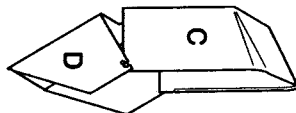

Figure 2 - Clip face shield halves together

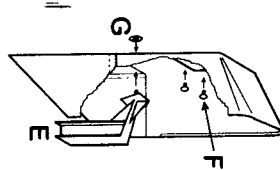

Figure 3 - Assemble lenses & handle to face shield

- ◆ Position pins "A" into the corresponding slots "B". See Figure 1.
- ◆ Clip the face shield halves "C" and "D" together. See Figure 2.
- ◆ Position hand grip "E" on the inside of the face shield using the threaded pin and positioning pin. Use the locking ring "G" to lock the hand grip into the face shield. Position the clear lens then the filter lens into the face shield from the inside. Use fixing screws "F" to fix the lenses into position. See Figure 3.

8. OPERATION

Conventional operating procedures apply when using the Welding Power Source, i.e. connect work lead directly to workpiece and electrode lead is used to hold electrode. Wide safety margins provided by the coil design ensure that the Welding Power Source will withstand short term overload without adverse effects. The welding current range values should be used as a guide only. Current delivered to the arc is dependent on the welding arc voltage, and as welding arc voltage varies between different classes of electrode, welding current at any one setting would vary according to the type of electrode in use. The operator should use the welding current range values as a guide, then finally adjust the current setting to suit the application.

8.1 Compact and Compact Turbo Controls

- a) ON/OFF Switch
This switch connects the Mains supply voltage to the welding transformer when in the ON position which enables the user to commence welding.
- b) Thermal Overload Light
The welding transformer is protected by a self resetting thermostat. If the overload light illuminates then wait for the overload light to extinguish before resuming your arc welding.
- c) Welding Current Control
The welding current is increased by turning the Current Control clockwise or decreased by turning the Current Control anti-clockwise.

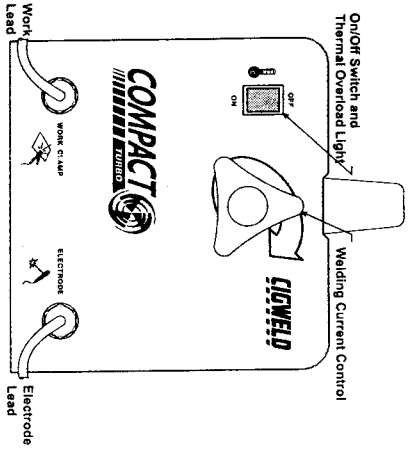

8.2 Easywelder Turbo Controls

- a) ON/OFF Switch
This switch connects the Mains supply voltage to the welding transformer when in the ON position which enables the user to commence welding.
- b) Thermal Overload Light
The welding transformer is protected by a self resetting thermostat. If the overload light illuminates then wait for the overload light to extinguish before resuming your arc welding.
- c) Welding Current Control
The welding current is increased by turning the Current Control clockwise or decreased by turning the Current Control anti-clockwise.
- d) LO Electrode Terminal
The Low Range Terminal is a heavy duty bayonet type terminal with a high OCV (Open Circuit Voltage) and is designed for electrodes that generally require an OCV less than or equal to 73 Volts, eg low hydrogen (AS/NZS E4818) type electrodes. It is essential, however, that the male plug is inserted and turned securely to achieve a good electrical connection. See CAUTION 1.
- e) HI Electrode Terminal
The High Range Terminal is a heavy duty bayonet type terminal with a low OCV (Open Circuit Voltage) and is designed for electrodes that require an OCV less than or equal to 48 Volts. It is essential, however, that the male plug is inserted and turned securely to achieve a good electrical connection. See CAUTION 1.

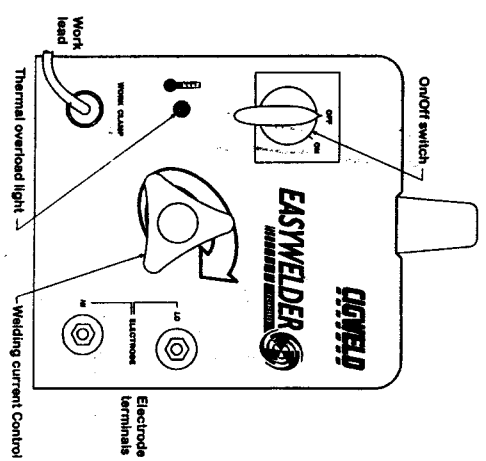

CAUTION 1
A loose welding terminal connection can cause overheating and result in the male plug being fused in the bayonet terminal.

9. SETUP FOR ARC WELDING

WARNING 4
Before connecting the work clamp to the work and inserting the electrode in the electrode holder make sure the Mains power supply is switched off.

CAUTION 2
Remove any packaging material prior to use. Do not block the air vents at the front or rear of the Welding Power Source.

6.2 Easywelder Turbo Specifications

Description (Refer NOTE 2)	Easywelder Turbo	
Product Part Number	620467	
Cooling	Fan Cooled	
Welder Type & Welding process	Heavy Duty, Leakage reactance, Manual Metal Arc Welding	
Welding Power Source mass	23kg	
Dimensions	H 360mm x W 270mm x D 525mm	
Manufactured to Australian Standard	AS3195	
Number of Phases	Single phase	
Nominal Supply Voltage	240V	
Nominal Supply Frequency	50Hz	
Effective Input Current	∇ 12.3A	
Flexible Supply Cable Size	15A Heavy Duty	
Thermal Protection	Yes: Self Resetting	
Current Range	I0	HI
Maximum Input Current @ 5% Duty Cycle	44.7A	40.4A
Maximum Input Current for Short Circuit	50A	49A
Single Phase Generator Requirement	✦ 11kVA	
Recommended Rated Outlet	15A	✦ 8.5kVA
Recommended Wire Fuse Size	✦ 30A	✦ 30A
Welding Current Range	35 - 135A	35 - 170A
Welding Current	50A @ 25% duty cycle 135A @ 5% duty cycle	75A @ 25% duty cycle 170A @ 5% duty cycle
Open Circuit Voltage	72V	48V

∇ The Effective Input Current should be used for the determination of cable size & supply requirements.

✦ Motor start fuses or thermal circuit breakers are recommended for this application. Australian Standard AS3000 permits the rating of the fuse or thermal circuit breaker protecting the circuit conductors, to be double the outlet current rating for any circuit used exclusively for an electric arc welder. Check local requirements for your situation in this regard.

✦ Generator Requirements at the Maximum Output Duty Cycle

6.3 Plant Contents

Description	Compact	Compact Turbo	Easywelder Turbo
Welding Power Source	✓	✓	✓
Electrode lead	✓	✓	✓
Work lead	✓	✓	✓
Face shield	✓	✓	✓
Wire brush/Chipping hammer	✓	✓	✓
Sample electrodes	✓	✓	✓
Wheeling Kit	—	✓	✓
Operating Manual	✓	✓	✓

7. INSTALLATION RECOMMENDATIONS

7.1 Environment

These units is NOT designed for use in environments with increased hazard of electric shock.

- a) Examples of environments with increased hazard of electric shock are -
 - i) In locations in which freedom of movement is restricted, so that the operator is forced to perform the work in a cramped (kneeling, sitting or lying) position with physical contact with conductive parts;
 - ii) In locations which are fully or partially limited by conductive elements, and in which there is a high risk of unavoidable or accidental contact by the operator, or
 - iii) In wet or damp hot locations where humidity or perspiration considerable reduces the skin resistance of the human body and the insulation properties of accessories.
- b) Environments with increased hazard of electric shock do not include places where electrically conductive parts in the near vicinity of the operator, which can cause increased hazard, have been insulated.

7.2 Location

Be sure to locate the welder according to the following guidelines:

- a) In areas, free from moisture and dust.
- b) Ambient temperature between 0°C to 40°C.
- c) In areas, free from oil, steam and corrosive gases.
- d) In areas, not subjected to abnormal vibration or shock.
- e) In areas, not exposed to direct sunlight or rain.
- f) Place at a distance of 300mm or more from walls or similar that could restrict natural air flow for cooling.

7.3 Ventilation

Since the inhalation of welding fumes can be harmful, ensure that the welding area is effectively ventilated.

7.4 Mains Supply Voltage Requirements

The Mains supply voltage should be within ± 10% of the rated Mains supply voltage. Too low a voltage may cause poor welding performance. Too high a supply voltage will cause components to overheat and possibly fail.

The Welding Power Source must be:

- ◆ Correctly installed, if necessary, by a qualified electrician.
- ◆ Correctly earthed (electrically) in accordance with local regulations.
- ◆ Connected to the correct size power point and fuse as per the SPECIFICATIONS on pages 13 and 14.

7.5 Face Shield Assembly

- ◆ Remove the face shield halves and the hand grip from the packaging.
- ◆ Remove the lens fixing screws "F" and the locking ring "G" from the hand grip.

3 Place victim flat on their back on a hard surface, open airway - using head tilt and jaw support as shown.

4 Begin artificial breathing - 5 full breaths in 10 seconds, sealing nostrils with check or holding nose closed.



5 Check carotid pulse in neck. If pulse is present, continue E.A.R. 15 breaths per minute for adults, 20 breaths per minute for children.



6 If pulse is absent and you have been trained, begin cardio pulmonary resuscitation (C.P.R.)
 Cardiac Compression - depress lower end of breast bone (sternum) 4cm to 5cm, less for small children.
 One rescuer - 2 breaths, 15 compressions in 15 seconds, i.e. 4 cycles per minute.
 Two rescuers - 1 breath, 5 compressions in 5 seconds, i.e. 12 cycles per minute.

7 Check for return of pulse and breathing after 1 minute and at least every 2 minutes. Continue uninterrupted until trained assistance is available. When breathing and pulse return, turn on side and continue observation.



6. SPECIFICATIONS

6.1 Compact and Compact Turbo Specifications

Description (Refer NOTE 2)	Compact	Compact Turbo
Product Part Number	620465	620466
Cooling	Convection Cooled	Fan Cooled
Welder Type & Welding process	Light Duty, Leakage reactance, Manual Metal Arc Welding	Medium Duty, Leakage reactance, Manual Metal Arc Welding
Welding Power Source mass	14kg	17.3kg
Dimensions	H 290mm x W 230mm x D 450mm	H 325mm x W 275mm x D 480mm
Manufactured to Australian Standard	AS3195	AS3195
Number of Phases	Single phase	Single phase
Nominal Supply Voltage	240V	240V
Nominal Supply Frequency	50Hz	50Hz
Effective Input Current	V 5.6A	V 9.5A
Flexible Supply Cable Size	10A Heavy Duty	10A Heavy Duty
Thermal Protection	Yes, Self Resetting	Yes, Self Resetting
Maximum Input Current (@ 5% Duty Cycle)	25.5A	27.7A
Maximum Input Current for Short Circuit	34.0A	36.5A
Single Phase Generator Requirement	✦ 6.1kVA	✦ 6.7kVA
Recommended Rated Outlet	10A	10A
Recommended Wire Fuse Size	+ 16A	+ 16A
Welding Current Range	50 - 120A	50 - 130A
Welding Current @ 25% duty cycle	50A	80A
Welding Current @ 5% duty cycle	120A	130A
Open Circuit Voltage	48V	48V

∇ The Effective Input Current should be used for the determination of cable size & supply requirements.
 + Motor start fuses or thermal circuit breakers are recommended for this application. Australian Standard AS3000 permits the rating of the fuse or thermal circuit breaker protecting the circuit conductors, to be double the outlet current rating for any circuit used exclusively for an electric arc welder. Check local requirements for your situation in this regard.
 ✦ Generator Requirements at the Maximum Output Duty Cycle.

NOTE 2

Due to variations that can occur in manufactured products, claimed performance, voltages, ratings, all capacities, measurements, dimensions and weights quoted are approximate only. Achievable capacities and ratings in use and operation will depend upon correct installation, use, applications, maintenance and service.

4. SAFE PRACTICES FOR THE USE OF WELDING EQUIPMENT

In many situations the "striking" voltage can be hazardous. Any person touching simultaneously the electrode lead/terminal and the work lead/terminal may receive a serious electrical shock. Additional precautions must be exercised where two Welding Power Sources are being used close to each other because, under certain conditions, the voltages between the welding terminals of the two Welding Power Sources could be two times the specified open circuit voltage.

It is essential that the Welding Power Source is correctly installed, if necessary, by a qualified electrician and maintained in sound mechanical and electrical condition. It is also important that the Welding Power Source be switched off when not in use.

4.1 Precautions to be Taken by Operators

- ◆ Whenever practicable, all parts of the welding circuit should be isolated from earth and other conducting material and under no circumstances should any earthing conductor of the electrical installation be used in place of the work lead.
- ◆ The Mains supply voltage should be switched off before connecting or disconnecting welding leads. Welding lead connections must have clean contact surfaces and must be securely tightened. Poor connections will result in overheating and loss of welding current. All parts of the welding circuit, including the return paths, are to be considered electrically alive, so the operator must ensure that no part of the body is placed in such a position that it will provide a path for an electric current.
- ◆ Welding operators should avoid direct contact with the work to be welded or against any metal in contact with the work. When this cannot be avoided the operator must not touch any exposed portion of the electrode holder with any part of the body. Should this occur, the operator will risk completing the electrical circuit through the body.
- ◆ When welding in confined spaces, where reasonable movement is restricted, particular care must be taken to ensure that the area is well ventilated and the operator is under constant observation by a person who can immediately switch off the power and give assistance in an emergency.
- ◆ The flux covering of an electrode cannot be assumed to provide effective insulation, consequently an insulating glove must be worn when placing an electrode into its holder, or should it be necessary to handle an electrode once it is in contact with its holder.
- ◆ During pauses between welding runs, electrode holders should be so placed that they cannot make electrical contact with persons or conductive objects.
- ◆ The welding leads, both the electrode lead and the work lead, must be protected from damage. Damaged leads must not be used.
- ◆ Keep combustible materials away from the welding area. Have a suitable fire extinguisher handy.
- ◆ Do not stand on damp ground when welding.

4.2 Personal Protection

The radiation from an electric arc during the welding process can seriously harm eyes and skin. It is essential that the following precautions be taken:

- ◆ Gloves should be flameproof gauntlet type to protect hands and wrists from heat burns and harmful radiations. They should be kept dry and in good repair.
- ◆ Protective clothing must protect the operator from burns, spatter and harmful radiation. Woolen clothing is preferable to cotton because of its greater flame resistance. Clothing should be free from oil or grease. Wear leggings and spats to protect the lower portion of the legs and to prevent slag and molten metal from falling into boots or shoes.

◆ Face Shield

It is recommended to use a welding face shield, conforming to the relevant standards, when electric arc welding. Use a welding face shield in serviceable condition and fitted with an eye filter lens to safely reduce harmful radiation from the arc as per Table 1.

Welding current range	Electrode Diameter	Suggested Filter Lens
40 to 70A	2.0mm	Shade 8
55 to 90A	2.5mm	Shade 8
90 to 135A	3.2mm	Shade 10
135 to 200A	4.0mm	Shade 10

Table 1 - Filter lens size versus welding current/electrode size

Protective filter lenses are provided to reduce the intensity of radiation entering the eye thus filtering out harmful infra-red, ultra-violet radiation and a percentage of the visible light. Such filter lenses are incorporated within face shields. To prevent damage to the filter lenses from molten or hard particles an additional hard clear glass or special plastic external cover lens is provided. This cover lens should always be kept in place and replaced before the damage impairs your vision while welding.

5. RESUSCITATION FOR ELECTRIC SHOCK VICTIMS

Electric shock may kill immediately. Early resuscitation is required if a life is to be saved. Every Second Counts! Electrical currents may:

- ◆ Stop the heart;
- ◆ Cause contraction of the muscles of the body;
- ◆ Paralyse breathing due to paralysis of the centre of respiration in the brain;
- ◆ Cause burns.

The victims often cannot free themselves from the current and may not be able to breathe due to fixation of the chest.

5.1 Resuscitation

Efficient resuscitation requires training which is available from the St John's Ambulance Association, Red Cross and other sources.

1 Don't become a victim. Switch off power if possible. If 2 If unconscious, place victim on their side and clear vomit not, remove victim from contact, using some insulating material.

breathing by look, listen and feel. If not breathing, commence expired air resuscitation (E.A.R.). This should take no longer than 3 or 4 seconds.

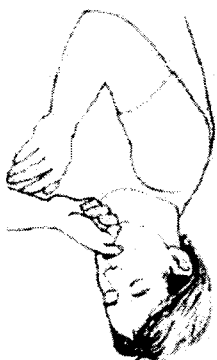

3.3 Easywelder Turbo

This heavy duty, dual range, fan cooled, portable arc welder has infinitely adjustable welding current from 30 to 190 amps and is designed to operate from a 240V, 15 amp power point. It is designed to meet the requirements of tradesmen, maintenance personnel, farmers and home handymen. The dual range welding output accommodates a wide material range including mild steel, stainless steel, alloy steel, cast iron and copper alloys for electrodes sizes from 1.6mm to 4.0mm.

3.4 User Responsibility

This equipment will perform as per the information contained herein when installed, operated, maintained and repaired in accordance with the instructions provided. This equipment must be checked periodically. Defective equipment (including welding leads) should not be used. Parts that are broken, missing, plainly worn, distorted or contaminated, should be replaced immediately. Should such repairs or replacements become necessary, it is recommended that such repairs be carried out by appropriately qualified persons approved by CIGWELD. Advice in this regard can be obtained by contacting accredited CIGWELD Distributor.

This equipment or any of its parts should not be altered from standard specification without prior written approval of CIGWELD. The user of this equipment shall have the sole responsibility for any malfunction which results from improper use or unauthorised modification from standard specification, faulty maintenance, damage or improper repair by anyone other than appropriately qualified persons approved by CIGWELD.

3.5 Duty Cycle

The rated duty cycle of a Welding Power Source, is a statement of the time it may be operated at its rated welding current output without exceeding the temperature limits of the insulation of the component parts. To explain the 10 minute duty cycle period the following example is used. Suppose a Welding Power Source is designed to operate at a 15% duty cycle, 90 amperes at 23.6 volts. This means that it has been designed and built to provide the rated amperage (90A) for 1.5 minutes, i.e. arc welding time, out of every 10 minute period (15% of 10 minutes is 1.5 minutes). During the other 8.5 minutes of the 10 minute period the Welding Power Source must idle and allowed to cool.

3.6 Terms Of Warranty - January 2000

1. The Trade Practices Act 1974 (Commonwealth) and similar State Territory legislation relating to the supply of goods and services, protects consumers' interests by ensuring that consumers are entitled in certain situations to the benefit of various conditions, warranties, guarantees, rights and remedies (including warranties as to merchantability and fitness for purpose) associated with the supply of goods and services. A consumer should seek legal advice as to the nature and extent of these protected interests. In some circumstances, the supplier of goods and services may legally stipulate that the said conditions, warranties, guarantees, rights and remedies are limited or entirely excluded. The warranties set out in Clause 2 shall be additional to any non-excludable warranties to which the Customer may be entitled pursuant to any statute.

2. Subject to Clause 3, CIGWELD gives the following warranties to the Customer:

Insofar as they are manufactured or imported by CIGWELD, goods will upon delivery be of merchantable quality and reasonably fit for the purpose for which they are supplied by CIGWELD.

CIGWELD will repair or, at its option, replace those of the goods which, upon examination, are found by CIGWELD to be defective in workmanship and/or materials.

CIGWELD reserves the right to request documented evidence of date of purchase.

3. The Warranty in Clause 2:
Is conditional upon:

The Customer notifying CIGWELD or our Accredited Distributor in writing of its claim within seven (7) days of becoming aware of the basis thereof, and at its own expense returning the goods which are the subject of the claim to CIGWELD or nominated Accredited Distributor/Accredited Service Agent.

The goods being used in accordance with the Manufacturer's Operating Manuals, and under competent supervision.

Does not apply to:

Obsolete goods sold at auction, second-hand goods and prototype goods.

Breakdown or malfunction caused by accident, misuse or normal wear and tear.

Repairs or replacement made other than by CIGWELD or Accredited Service Agents, unless by prior arrangement with CIGWELD.

Replacement parts or accessories which may affect product safety or performance and which are not manufactured, distributed or approved by CIGWELD.

4. CIGWELD declares that, to the extent permitted by law, it hereby limits its liability in respect of the supply of goods which are not of a kind ordinarily acquired for personal, domestic or household use or consumption to any one or more of the following (the choice of which shall be at the option of CIGWELD).
The replacement of the goods or the supply of equivalent goods.
The repair of goods.

The payment of cost of replacing the goods or acquiring equivalent goods.

The payment of the cost of having goods repaired.

5. Except as provided in Clauses 2 to 4 above, to the extent permitted by statute, CIGWELD hereby excludes all liability for any loss, damage, death or injury of any kind whatsoever occasioned to the Customer in respect of the supply of goods including direct, indirect, consequential or incidental loss, damage or injury of any kind.

3.7 Warranty Schedule - January 2000

These warranty periods relate to the warranty conditions in clause 2. All warranty periods are from date of sale from the Accredited Distributor of the equipment. Notwithstanding the foregoing, in no event shall the warranty period extend more than the time stated plus one year from the date CIGWELD delivered the product to the Accredited Distributor. Unless otherwise stated the warranty period includes parts and labour. CIGWELD reserves the right to request documented evidence of date of purchase.

CIGWELD STICK (MMAW) PRODUCTS	
Main Power Magnetics.....	1 year
Original Main Power Rectifiers, Control P. C. Boards.....	1 year
All other circuits and components including, but not limited to, relays, switches, contactors, solenoids, fans, power switch semi-conductors.....	1 year

Please note that the information detailed in this statement supersedes any prior published data produced by CIGWELD.



For the purpose of safety and performance and to protect your CIGWELD Equipment Warranty always use genuine CIGWELD replacement parts and accessories.

2. ELECTROMAGNETIC COMPATIBILITY

Extra precautions for Electromagnetic Compatibility may be required when this Welding Power Source is used in a domestic situation.

2.1 Installation and use - Users Responsibility

The user is responsible for installing and using the welding equipment according to the manufacturer's instructions. If electromagnetic disturbances are detected then it shall be the responsibility of the user of the welding equipment to resolve the situation with the technical assistance of the manufacturer. In some cases this remedial action may be as simple as earthing the welding circuit, see NOTE 1. In other cases it could involve constructing an electromagnetic screen enclosing the Welding Power Source and the work, complete with associated input filters. In all cases, electromagnetic disturbances shall be reduced to the point where they are no longer troublesome.

NOTE 1

The welding circuit may or may not be earthed for safety reasons. Changing the earthing arrangements should only be authorised by a person who is competent to assess whether the changes will increase the risk of injury, e.g. by allowing parallel welding current return paths which may damage the earth circuits of other equipment. Further guidance is given in IEC 974-13 Arc Welding Equipment - Installation and use (under preparation).

2.2 Assessment of Area

Before installing welding equipment, the user shall make an assessment of potential electromagnetic problems in the surrounding area. The following shall be taken into account

- i) Other supply cables, control cables, signalling and telephone cables: above, below and adjacent to the welding equipment.
- ii) Radio and television transmitters and receivers.
- iii) Computer and other control equipment.
- iv) Safety critical equipment, e.g. guarding of industrial equipment.
- v) The health of people around, e.g. the use of pacemakers and hearing aids.
- vi) Equipment used for calibration and measurement.
- vii) The time of day that welding or other activities are to be carried out.
- viii) The immunity of other equipment in the environment: the user shall ensure that other equipment being used in the environment is compatible: this may require additional protection measures.

The size of the surrounding area to be considered will depend on the structure of the building and other activities that are taking place. The surrounding area may extend beyond the boundaries of the premises.

2.3 Methods of Reducing Electromagnetic Emissions**a) Mains Supply**

Welding equipment should be connected to the mains supply according to the manufacturer's recommendations. If interference occurs, it may be necessary to take additional precautions such as filtering of the mains supply. Consideration should be given to shielding the supply cable of permanently installed welding equipment in metallic conduit or equivalent.

Shielding should be electrically continuous throughout it's length. The shielding should be connected to the Welding Power Source so that good electrical contact is maintained between the conduit and the Welding Power Source enclosure.

b) Maintenance of Welding Equipment

The welding equipment should be routinely maintained according to the manufacturer's recommendations. All access and service doors and covers should be closed and properly fastened when the welding equipment is in operation. The welding equipment should not be modified in any way except for those changes and adjustments covered in the manufacturer's instructions. In particular, the spark gaps of arc striking and stabilising devices should be adjusted and maintained according to the manufacturer's recommendations.

c) Welding Cables

The welding cables should be kept as short as possible and should be positioned close together, running at or close to the floor level.

d) Equipotential Bonding

Bonding of all metallic components in the welding installation and adjacent to it should be considered. However, Metallic components bonded to the work piece will increase the risk that the operator could receive a shock by touching the metallic components and the electrode at the same time. The operator should be insulated from all such bonded metallic components.

e) Earthing of the Workpiece

Where the workpiece is not bonded to earth for electrical safety, nor connected to earth because of it's size and position, e.g. ship's hull or building steelwork, a connection bonding the workpiece to earth may reduce emissions in some, but not all instances. Care should be taken to prevent the earthing of the workpiece increasing the risk of injury to users, or damage to other electrical equipment. Where necessary, the connection of the workpiece to earth should be made by direct connection to the workpiece, but in some countries where direct connection is not permitted, the bonding should be achieved by suitable capacitance, selected according to national regulations.

f) Screening and Shielding

Selective screening and shielding of other cables and equipment in the surrounding area may alleviate problems of interference. Screening the entire welding installation may be considered for special applications.

3. GENERAL INFORMATION**3.1 Compact**

This compact, portable, home handyman arc welder has infinitely adjustable welding current from 50 to 120 amps and is designed to operate from a domestic 240V, 10 amp power point. It runs standard general purpose 2.5mm electrodes for light gauge work, generally less than 3.0mm thick, and 3.2mm electrodes for heavier materials.

3.2 Compact Turbo

This compact heavy duty, fan cooled, portable, home handyman arc welder has infinitely adjustable welding current from 50 to 130 amps and is designed to operate from a domestic 240V, 10 amp power point. It runs standard general purpose 2.5mm electrodes for light gauge work, generally less than 3.0mm thick, and 3.2mm electrodes for heavier materials.

1. INTRODUCTION**1.1 Notes, Cautions and Warnings**

Throughout this manual, notes, cautions, and warnings are used to highlight important information. These highlights are categorised as follows:

NOTE

An operation, procedure, or background information which requires additional emphasis or is helpful in efficient operation of the system.

CAUTION

A procedure which, if not properly followed, may cause damage to the equipment.

**WARNING**

A procedure which, if not properly followed, may cause injury to the operator or others in the operating area.

1.2 Important Safety Precautions**WARNING 1**

OPERATION AND MAINTENANCE OF WELDING ARC EQUIPMENT CAN BE DANGEROUS AND HAZARDOUS TO YOUR HEALTH.

To prevent possible injury, read, understand and follow all warnings, safety precautions and instructions before using the equipment. Call your local distributor if you have any questions.

**GASES AND FUMES**

Gases and fumes produced during the welding process can be dangerous and hazardous to your health.

- ◆ Keep all fumes and gases from the breathing area. Keep your head out of the welding fume plume.
- ◆ Use an air-supplied respirator if ventilation is not adequate to remove all fumes and gases.
- ◆ The kinds of fumes and gases from the welding arc depend on the kind of metal being used, coatings on the metal, and the different processes. You must be very careful when cutting or welding any metals which may contain one or more of the following:

Antimony	Beryllium	Cobalt	Manganese	Selenium
Arsenic	Cadmium	Copper	Mercury	Silver
Barium	Chromium	Lead	Nickel	Vanadium

- ◆ Always read the Material Safety Data Sheets (MSDS's) that should be supplied with the material you are using. These MSDS's will give you the information regarding the kind and amount of fumes and gases that may be dangerous to your health.
- ◆ Use special equipment, such as water or down draft cutting tables, to capture fumes and gases.
- ◆ Do not use the welding torch in an area where combustible or explosive gases or materials are located.
- ◆ Phosgene, a toxic gas, is generated from the vapours of chlorinated solvents and cleansers. Remove all sources of these vapours.
- ◆ Refer to the Victorian Occupational Health and safety (Confined Spaces) Regulations 1996 and Code of Practice or its equivalent for other states and / or countries.

**ELECTRIC SHOCK**

Electric Shock can injure or kill. The welding arc process uses and produces high voltage electrical energy. This electric energy can cause severe or fatal shock to the operator or others in the workplace.

- ◆ Never touch any parts that are electrically "live" or "hot."
- ◆ Wear dry gloves and clothing. Insulate yourself from the work piece or other parts of the welding circuit.
- ◆ Repair or replace all worn or damaged parts.
- ◆ Extra care must be taken when the workplace is moist or damp.
- ◆ Install and maintain equipment according with local regulations.
- ◆ Disconnect power supply before performing any service or repairs.
- ◆ Read and follow all the instructions in the Operating Manual.

**FIRE AND EXPLOSION**

Fire and explosion can be caused by hot slag, sparks, or the welding arc.

- ◆ Be sure there is no combustible or flammable material in the workplace. Any material that cannot be removed must be protected.
- ◆ Ventilate all flammable or explosive vapours from the workplace.
- ◆ Do not cut or weld on containers that may have held combustibles.
- ◆ Provide a fire watch when working in an area where fire hazards may exist.
- ◆ Hydrogen gas may be formed and trapped under aluminium workpieces when they are cut underwater or while using a water table. **DO NOT** cut aluminium alloys underwater or on a water table unless the hydrogen gas can be eliminated or dissipated. Trapped hydrogen gas that is ignited will cause an explosion.

**NOISE**

Noise can cause permanent hearing loss. Plasma arc processes can cause noise levels to exceed safe limits. You must protect your ears from loud noise to prevent permanent loss of hearing.

- ◆ To protect your hearing from loud noise, wear protective ear plugs and/or ear muffs. Protect others in the workplace.
- ◆ Noise levels should be measured to be sure the decibels (sound) do not exceed safe levels.

**ARC RAYS**

Arc Rays can injure your eyes and burn your skin. The welding arc process produces very bright ultra violet and infra red light. These arc rays will damage your eyes and burn your skin if you are not properly protected.

- ◆ To protect your eyes, always wear a welding face shield. Also always wear safety glasses with side shields, goggles or other protective eye wear.
- ◆ Wear welding gloves and suitable clothing to protect your skin from the arc rays and sparks.
- ◆ Keep welding face shield and safety glasses in good condition. Replace lenses when cracked, chipped or dirty.
- ◆ Protect others in the work area from the arc rays. Use protective booths, screens or shields.
- ◆ Use the shade of lens as recommended in this Operating Manual.

CONTENTS

	Page
1. INTRODUCTION	4
2. ELECTROMAGNETIC COMPATIBILITY	6
3. GENERAL INFORMATION	7
4. SAFE PRACTICES FOR THE USE OF WELDING EQUIPMENT	10
5. RESUSCITATION FOR ELECTRIC SHOCK VICTIMS	11
6. SPECIFICATIONS	13
7. INSTALLATION RECOMMENDATIONS	15
8. OPERATION	16
9. SETUP FOR ARC WELDING	17
10. ARC WELDING ELECTRODES	18
11. ARC WELDING PRACTICE	20
12. ARC WELDING TECHNIQUE	22
13. DISTORTION	25
14. ROUTINE MAINTENANCE & INSPECTION	28
15. BASIC TROUBLESHOOTING	28

TABLES

Table 1 - Filter lens size verses welding current/electrode size	11
Table 2 - Types of Electrodes	19

FIGURES

	Page
Figure 1 - Hook face shield halves together	16
Figure 2 - Clip face shield halves together	16
Figure 3 - Assemble lenses & handle to face shield	16
Figure 4 - Flat position, down hand butt weld	20
Figure 5 - Flat position, gravity fillet weld	20
Figure 6 - Horizontal position, butt weld	20
Figure 7 - Horizontal - Vertical (HV) position	20
Figure 8 - Vertical position, butt weld	20
Figure 9 - Vertical position, fillet weld	20
Figure 10 - Overhead position, butt weld	21
Figure 11 - Overhead position fillet, weld	21
Figure 12 - Typical joint designs for arc welding	21
Figure 13 - Striking an arc	22
Figure 14 - Butt weld	23
Figure 15 - Weld build up sequence	23
Figure 16 - Electrode position for HV fillet weld	24
Figure 17 - Multi-runs in HV fillet weld	24
Figure 18 - Single run vertical fillet weld	24
Figure 19 - Multi run vertical fillet weld	24
Figure 20 - Examples of vertical fillet welds	25
Figure 21 - Overhead fillet weld	25
Figure 22 - Parent metal expansion	26
Figure 23 - Parent metal contraction	26
Figure 24 - Principle of presetting	27
Figure 25 - Reduction of distortion by preheating	27
Figure 26 - Examples of distortion	27
Figure 27 - Welding sequence	27
Figure 28 - Step back sequence	27
Figure 29 - Chain intermittent welding	27
Figure 30 - Staggered intermittent welding	27
Figure 31 - Examples of slag inclusion	29
Figure 32 - Examples of undercut	30
Figure 33 - Example of lack of fusion	30