

## OPERATING MANUAL FOR IMPULSE CT CORDLESS NAILER

Addition to the General Safety Manual for Internal Combustion Fastener Driving Tools

### 1. Before using the Tool

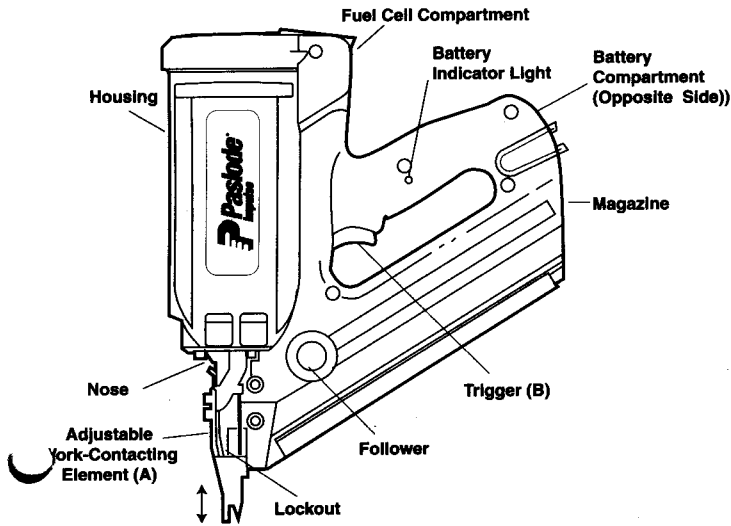

Read safety and operating manuals. Only use the tool when all instructions are understood. Check work contact element/ safety yoke (A) for smooth operation.

Use only for timber to timber fixings or material of similar or lesser density.

Attention: This tool must not be used in a combustible environment.

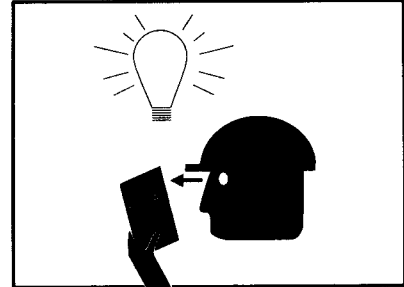

### 2. Battery Loading

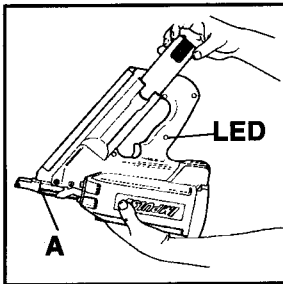

Load Impulse battery cell with contacts facing downwards into the battery compartment. Press firmly until battery locking clip is engaged. To remove battery press the locking clip on the battery and slide battery out of its compartment.

LED in Handle of Tool:

LED strobe light green > Battery in tool. (Does not indicate state of charge)

LED strobe light red > Battery is empty, recharge battery!

When work contact element (A) is depressed against workpiece:

LED solid green > Battery charge ready for use.

LED solid red > Battery empty. Recharge!

To recharge battery read charging instructions.

Battery contacts must be clean and free from corrosion; if necessary clean with fine emery cloth.

### 3. Loading Fuel Cell

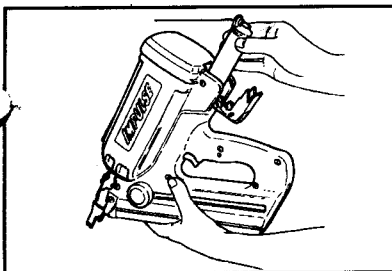

Prior to loading fuel cell ensure that the cell protective cap has been removed as detailed in the safety manual. For the Impulse CT nailer use fuel cells with the red ring on metering valve.

To load fuel:-

1. Open the cover of the fuel cell compartment by pressing inwards and lifting.
2. Insert fuel cell into fuel compartment and locate the stem of the metering valve into the orifice in the red adaptor.
3. Close the cover of the fuel compartment, taking care not to disturb the alignment of the fuel cell.

### 4. Fastener Loading, Reloading and Removal

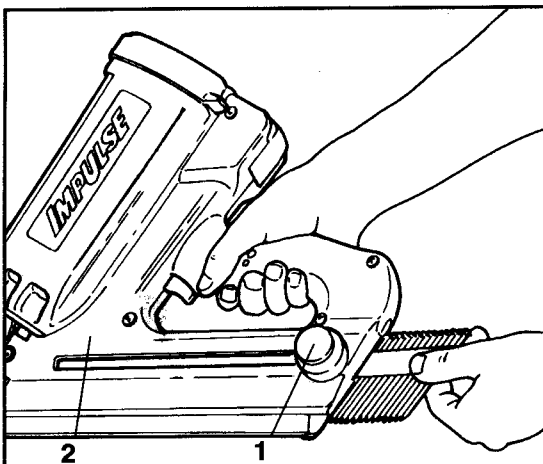

To load Fasteners:

1. Pull back the follower (1) until it reaches the locked position at the end of the magazine.
2. Insert Paslode fasteners selected from technical specification sheet into the slot at the rear of the magazine.  
The fasteners will slide freely into the tool.
3. Release the follower lock by depressing centre button on the follower and gently allow the follower to push the fastener strip forward to the correct firing position.  
Do not allow the follower to spring forward against the fastener strip otherwise collation may be damaged.
4. Reload tool when centre button has reached "reload" arrow (2) or lock-out mechanism is activated.
5. To unload fasteners again pull back follower to the locked position and simply slide out fasteners.

Note: 1) Do not depress trigger when loading or unloading fasteners.

2) The lockout mechanism is activated when approx. 5 nails remain in magazine.  
To remove these refer to point 5 above.

**With fasteners, Battery and Fuel Cells loaded the Tool is now ready for use.**

Manual # 613

Plant No. 2528 001 and 003.

REPLACED  
06/10

Nail Gun Impulse Fixing.

**Paslode**  
CORDLESS

Model: IM250 II  
Part No. 900400  
Cordless 16 Gauge Finish Nailer

**MODEL IM250 F-16 II  
CORDLESS FINISH NAILER**

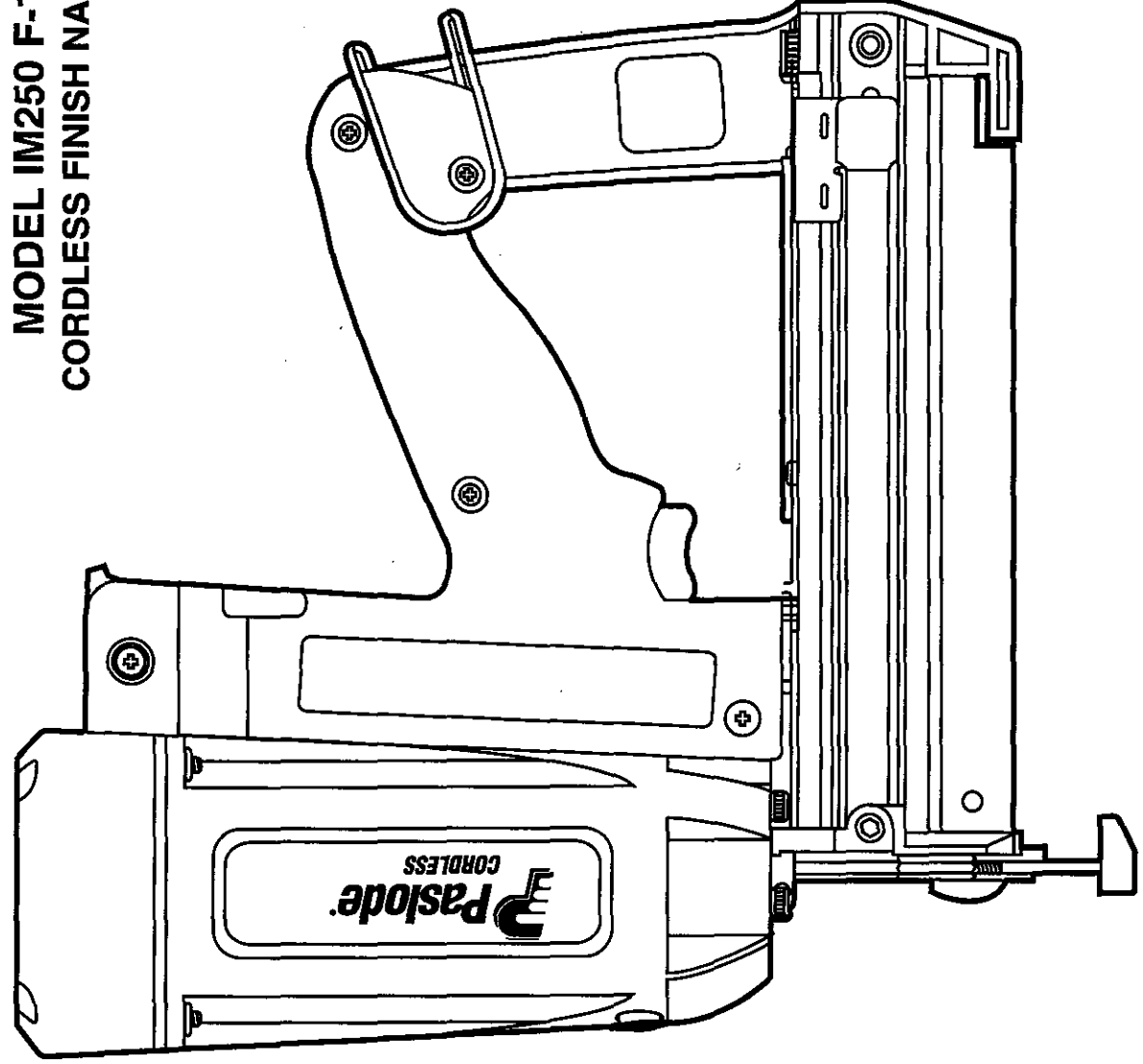

T(

**IMPORTANT!**  
**DO NOT DESTROY**  
Always refer to operators manual #405606 for detailed information on this tool. It is the customers responsibility to have all operators and service personnel read and understand this information.

### 1. Before Using the Tool

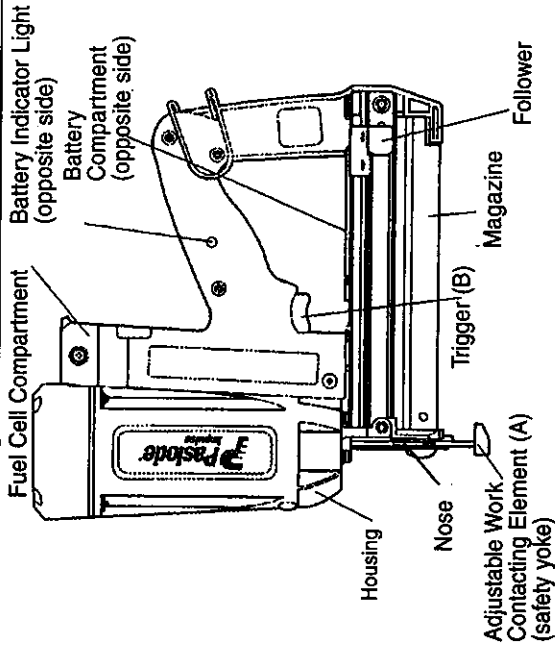

Read safety and operating manuals. Only use the tool when all instructions are understood. Check the work contacting element/safety yoke **A** for smooth operation before use.

For use only on timber to timber fixings or material of similar or lesser density.

**Attention:** Use only in well ventilated areas and away from combustible materials.



### 2. Battery Loading

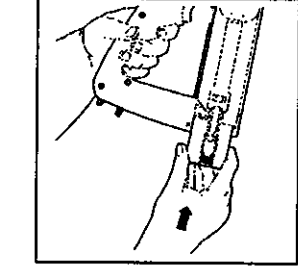

Load impulse battery cell with contacts facing downwards into the battery compartment. Press firmly until battery locking clip is engaged. To remove battery press the locking clip on the battery and slide battery out of its compartment.

#### LED in Handle of the tool:

- LED strobe light green - Battery in tool (Does not indicate state of charge)
- LED strobe light red - Battery is empty, recharge battery!
- LED solid green - Work contacting element is depressed against work piece. Battery charge ready for use.
- LED solid red - Work contacting element is depressed against work piece. Battery empty. Recharge!

**Note:** Approximately 4000 fasteners can be driven from a fully charged battery.

To recharge battery read charging instructions.

Battery contacts must be clean and free from corrosion, if necessary clean with fine emery cloth.

### 3. Loading Fuel Cell

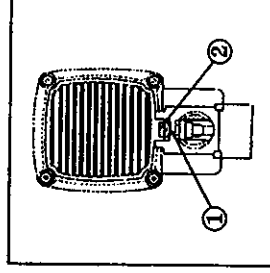
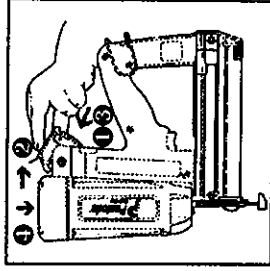

Prior to loading fuel cell ensure that the protective cap has been removed as detailed in the safety manual. For the Impulse Finishing Nailer use fuel cells with green ring on metering valve. (Functioning range +8°C - +35°C)

To load fuel cell:

1. Open the cover of the fuel cell compartment by pressing inwards ① and lifting ②.
2. Insert fuel cell into fuel cell compartment and locate the stem ① of the metering valve into the orifice in the adaptor ②.
3. Close the cover of the fuel cell compartment. Do this by swinging it up ③ and over the fuel cell assembly. Push it down ④ until it snaps into position.

**Note:** Approx. 1800 fasteners can be fired with one new fuel cell.

### 4. Fastener Loading, Reloading, Removal

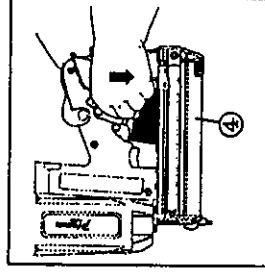
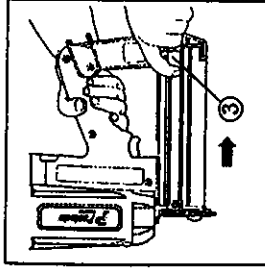

**Fastener: Use only Paslode F16 brads**

**Attention:** Do not depress trigger **B** when loading or unloading tool.

**To load Fasteners:**

Pull follower ③ back until it reaches locked position at the end of magazine ④. Insert one or two strips of PASLODE fasteners from top side into the magazine ④ between the two wear strips. The strips will slide freely into the magazine.

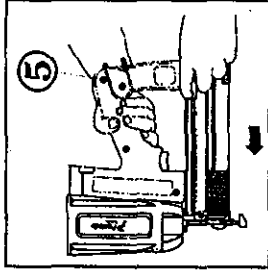

## 5. Trigger System

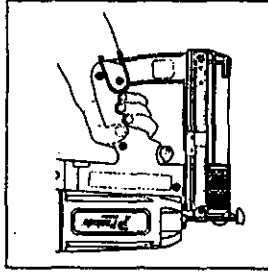

Release the follower ③ by pressing the rail cover ⑤ backwards and gently slide the follower ③ forward against the fasteners. The constant force spring slides the fasteners into the nose-piece.

### The Tool is ready for Use.

**Note:** When releasing the follower do not impact the fastener strip. This can damage the fastener strip and cause malfunctioning.

### Reload the Magazine:

The tool should be reloaded when no more fasteners are visible in the rail or when required. Don't blank fire. To reload the tool follow steps listed above. → Load Fasteners.

### Remove Fasteners:

Pull follower ③ back until it reaches locked position. Pull the fasteners out of the magazine ④.

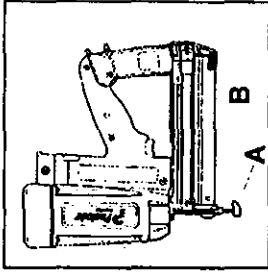

The Impulse Finishing Nailer is equipped with a fully sequential triggering system for maximum safety. For each firing cycle it is necessary that the work contacting element A and the trigger B are both fully depressed and released prior to successive firing operations.

- ① Place tool with the work contacting element A onto the work piece.

- ② Press tool against work piece to fully depress the work contacting element A and in 1 to 2 seconds...

- ③ ...press trigger B. Fastener will be driven.

- ④ Lift off tool and release trigger B.

## 6. Tool Operation and Application

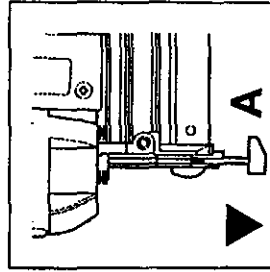

**Application:** Fixing wood to wood or materials with similar density.

**Attention:** For proper use it is necessary to use a fuel cell with green ring on the metering valve and a fully charged battery.

- Attention:**
1. Press the tool firmly with the work contacting element A against the working piece. Fan motor starts, fuel is injected into the combustion chamber and mixed with air by the fan.
  2. Squeeze the trigger B. The ignition takes place and the piston drives a fastener.
  3. Lift tool up from work piece. Combustion chamber opens. Fan exhausts hot gas and cools tool. The fan runs for ten more seconds.
  4. The tool is ready for a new cycle.

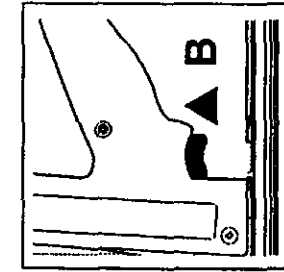

**Note:** Never cover the top side of the tool. This may overheat or damage to the tool.

### Cycle Rate:

Intermittent operation: 2-3 Fasteners/Second

Continuous operation: Max. 1000 Fasteners/Hour

**Note:** You can start the fan by squeezing the trigger B without pressing the tool against the work piece when necessary to cool the tool.

**Note:** When the tool is not in use. Remove battery, fuel cell and all fasteners. Wipe with a clean soft cloth when it is dirty and place it in the tool case.

## 7. Depth of Drive Adjustment

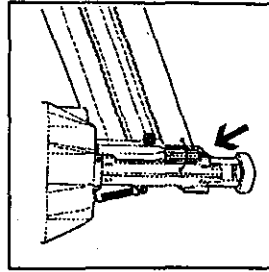

**Note:** Before adjusting tool remove always battery and fuel cell.

The depth of drive is adjusted by turning the adjustment knob on the work contacting element.

When work contacting element is adjusted check driving depth by nailing.

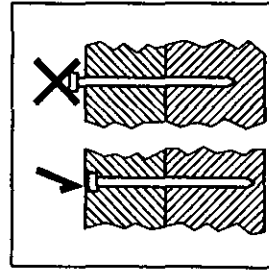

## 8. Clearing a Nail Jam

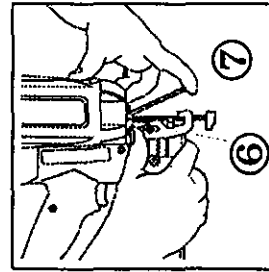

Remove battery and fuel cell.

Pull follower ③ back until it latches at the end of magazine ④. Remove fasteners.

Push latch ⑥ releasing the front guide ⑦. Pivot front guide forward.

Clear jam and push back driver blade when necessary.

Close the front guide and latch it. Check the work contacting element for free moving.

Resume operation according to step 2-4.



# GENERAL SAFETY MANUAL FOR INTERNAL COMBUSTION FASTENER DRIVING TOOLS

Page	Page
1 ... 4	17 ..... 20
5 ... 8	21 ..... 24
9 ... 12	25 ..... 28
13 .. 16	29 ..... 32

DK

S

N

SF

Congratulations on having chosen a Paslode product. Your tool will operate to your full satisfaction for a long time if handled correctly according to the General Safety Manual and Tool Operating Manual. Use Paslode specified fasteners, fuel cell, rechargeable battery and spare parts only.

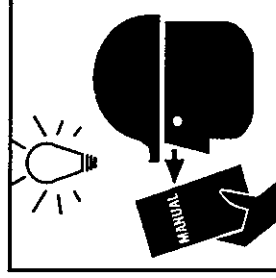
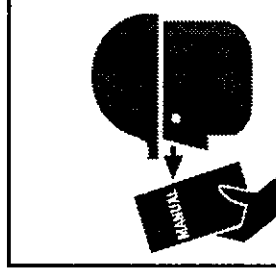
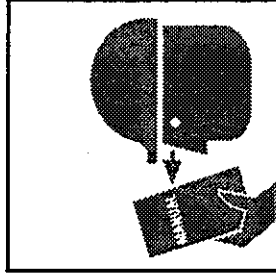
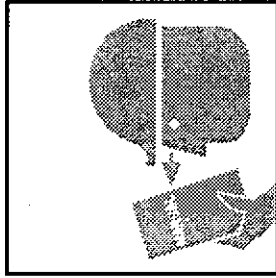

Read all safety and operating instructions about tool, fuel cell, battery and battery charger and observe them carefully.

## Safety Instructions

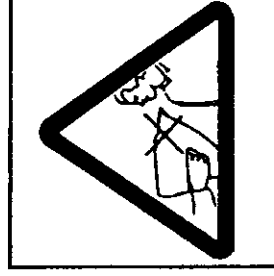
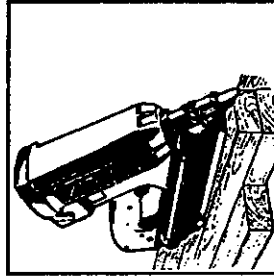

**IMPULSE SYSTEM**  
The IMPULSE SYSTEM consists of tool, fasteners, fuel cell, battery and battery charger. Only Paslode-specified fasteners fuel cell, battery and battery charger may be used. Reference the spec. sheet of the tool. The specified units must be seen as a single system in terms of technical safety.

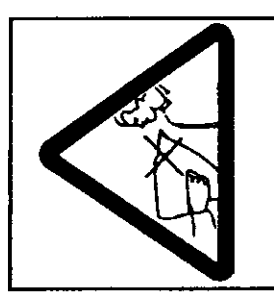

### FASTENER TOOLS

Never carry tool with trigger depressed. Do not point the work contacting element(safety yoke)at your own body or at somebody else. After having work completed, take fuel cell and battery out of tool. Keep tool and parts away from children and unauthorized persons. Store tool, battery and fuel cell in tool case when not using it for some time.

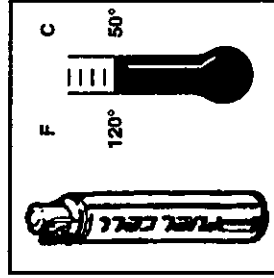
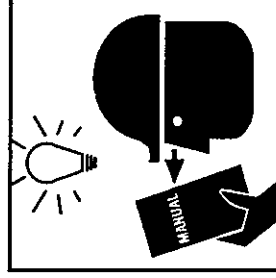

**IMPULSE FUEL CELL**  
The fuel cell is an aerosol product, the contents are flammable. The container is under pressure. Protect from exposure to temperatures above 50°C (120°F) (i.e. sunlight)! Do not spray against open flame or hot surfaces. Use outside or in well-ventilated areas. Do not burn, attempt to open, or puncture after use. Dispose of according to local regulations for aerosol products.

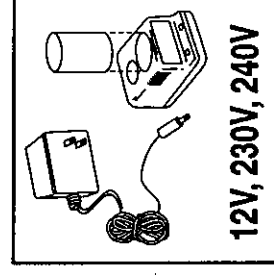

**IMPULSE BATTERY-BATTERY CHARGER**  
Use only Paslode IMPULSE 6V battery and IMPULSE battery charger. Check for correct electric voltage. Observe data on battery charger. Store indoors at temperatures below 50°C. Do not recharge at temperatures below 5°C or above 40°C. Do not open battery and do not throw into fire. Do not dispose of with garbage. Observe local regulations for disposal.

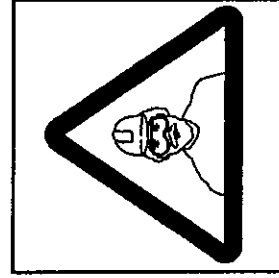

**EYE PROTECTION**  
When operating the tool always wear approved eye protection. Small fragments might be shot from work piece. Eye protection is also recommended for persons close to work place.

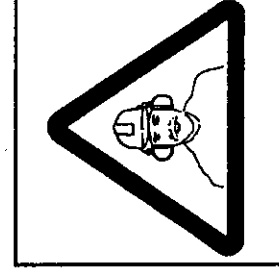

**HEARING PROTECTION**  
Wear hearing protection when operating the tool. This reduces the sound level at your ear considerably. Hearing protection is also recommended for persons close to the work place.

# IMPULSE SYSTEM

## Impulse Tool

GB

### The tool consists of three main assemblies:

#### Housing with:

Combustion Chamber,  
Nosepiece, Safety Yoke,  
Piston and Driver.

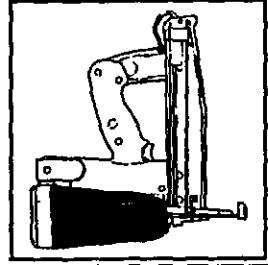

#### Handle with:

Tool Electronic, Motor,  
Spark plug, Trigger and  
Compartment for fuel cell.

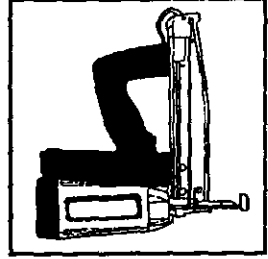

#### Magazine for:

Consumables with  
follower and compartment  
for Battery.

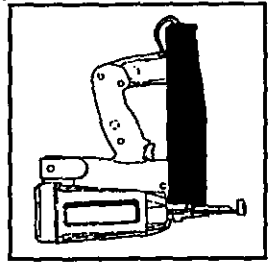

#### Fuel Cell:

Consisting of container for  
fuel (1) and propellant  
metering valve (2) and  
protective cap (3).

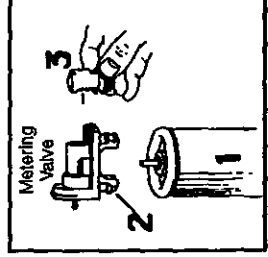

#### Battery/Battery

##### Charger

The battery supplies  
power to the tool  
electronic, fan, and spark  
plug.

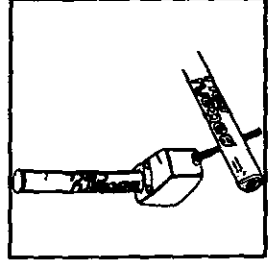

## Impulse-Tool: Operation

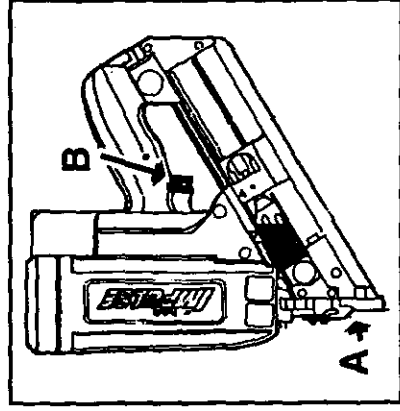

Impulse tool works according to the principles of a linear internal combustion engine.

Press work contacting element of the tool (A) against work piece.  
Combustion chamber is closing and fuel injected.  
Fan mixes air and fuel.

Fuel/air mixture ignites by pulling trigger (B).  
Combustion drives piston with driver.  
Piston and driver return to initial position.

Lift tool from work piece.  
Combustion chamber opens and releases exhaust fumes.  
Fan cools tool.  
Impulse tool is ready for next single cycle.

## Impulse-Fuel Cell: Technology/Service/Safety

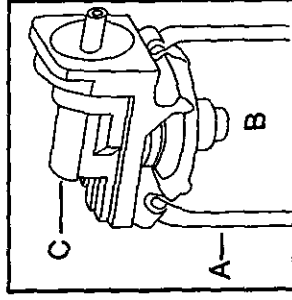

The fuel cell is an Aerosol product according to regulation 75/324 EEC and TRG 300 (D). The propellant (A) keeps the fuel (B) in the inner container permanently pressurized. The metering valve (C) regulates the correct fuel dosage for each cycle.

Contents of Fuel Cell:  
-Hydrocarbon liquid, i.e. propane, butane.  
-Lubrication for piston.

*Typical smell of mercaptane.*

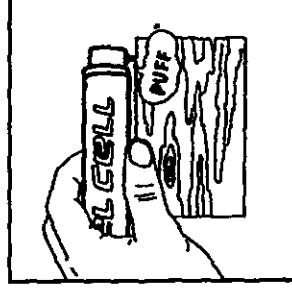

Press metering valve stem on fuel cell three times against a stationary object and release. If gas is not dispersed, fuel cell is empty-replace it. Use the right fuel cell to ensure the correct dosage of fuel. Look for the correct colour of the dosage valve ring (see tool operating manual).

Observe Safety Regulations.

**Safety Regulations:** The propellant will remain in the fuel cell. Fuel cell is always under pressure. Propellant and fuel are flammable. Expanding gases cause low temperatures. Caution, fluid gases might cause injuries when getting in touch with skin or eyes. The fuel cell is to be used as stated in the "Fuel Cell" section. Refill forbidden!

## Impulse – Fuel Cell: Symbols and their Meanings



Contains no  
chlorofluorocarbon.



Danger!  
Flammable liquid  
agents and gases.



Net capacity (ml)  
of fuel cell.



Reverse Epsilon.  
Aerosol Product  
according to  
regulation  
75/324/EEC.



Weight of contents  
according to  
official standards.

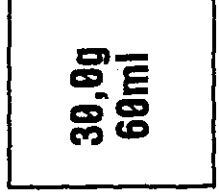

Fuel weight/  
volume in inner  
container.

# IMPULSE-Fuel Cell: Preparation for Use

GB

The fuel cell is equipped with a safety device for transportation and cannot be placed into tool as delivered. Get it ready for use by observing the following steps:

**NOTE:** Do not smoke when handling the fuel cell, do not inhale its contents.

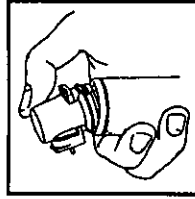

Lift protective cap and dosage valve from fuel cell.

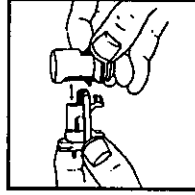

Separate metering valve from protective cap.

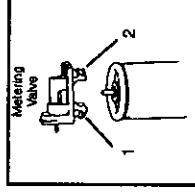

Metering valve has a front 1 and back 2 ridge to fit on fuel cell.

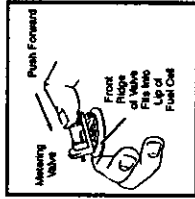

Place front ridge of metering valve into lip of fuel cell.  
**WARNING**  
Keep valve stem away from face and eyes.

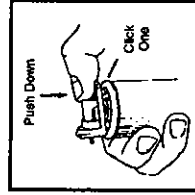

Press back ridge of valve firmly over lip of fuel cell.

**FIRST CLICK!**

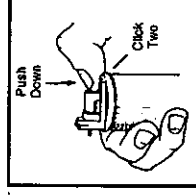

Press valve further down firmly until it snaps into place.  
**SECOND CLICK!**  
Valve fits.

## IMPULSE-Fuel Cell: Transportation/ Storage

### Transportation

According to GGVs-ADR no special licence is demanded for transportation of fuel cells.

- Road/Railway: see GGVs-ADR/RID Cl.2/ITEM 10B2
- Seafreight/Boat: see IMDG Cl.9/P.9022/EmS No. 2-13
- Air/IATA-DGR: see Cl.2/Risk Gr.3/PackInst. 203/ max. weight per shipment 75 kg/ cargo 150 kg.

### NOTE:

- Goods must be accompanied by transport emergency card for road UN No. 1950.  
(Emergency Cl.2 GGVs/ADR, Rn. No. 2201, Item 10B2)
- Transportation of small quantities for own use in private car is allowed without shipping papers and emergency card.  
Observe temperature limit of 50°C

### Safety Rules:

- Shipment of fuel cells per mail is not allowed.

### Storage:

All local instructions according to fire brigade regulations have to be observed. Store- and sales rooms must be in line with the rules of the Building Supervisory Authorities.

- Do not store above 50°C; do not store in passages, entry halls or near doors.
- Always keep room well ventilated.
- In store rooms fuel cells must not take more than 20 square meters of room surface.
- Do not store together with pyrotechnical goods.
- The quantity stored in sales rooms should not exceed daily sales.
- Sales booths should not be close to exits. A fire extinguisher of 6kg, class A, B, C must be available.
- Tools with an open flame or high temperature must not be operated near fuel cells.
- Fuel cells must not be displayed in shop windows.

## General Notes: IMPULSE -Operation and Service

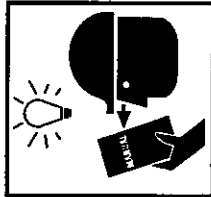

Understand operating manual and safety instructions before operation.



Only use specified Paslode fasteners and spare parts.

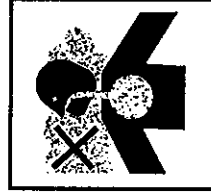

Only work outside or in well ventilated area.

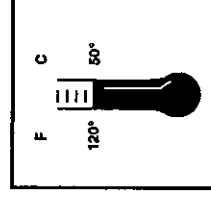

Never heat fuel cell and tool loaded with fuel cell above 50°C.

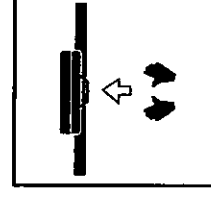

Put tool into tool case for storing and transportation.

Keep out of reach of children.



Do not use tool in the rain or where excessive moisture is present.

The following servicing can be performed by yourself: ( also see tool operating manual)

- Clean tool with soft cloth or brush, lubricate trigger and safety yoke if necessary slightly with Impulse oil.
- Check safety nose for smooth running.
- Adjust driving-in depth.
- Check and reload battery.
- Check fuel cell for functioning.
- Clean air filter.
- Clean points of contact of battery.
- Check wire.
- Clear a fastener jam.

### Beware!

Before performing any servicing take fuel cell, battery and fasteners out of tool.

If you can not service the tool properly, send it to your Paslode service station for a check up. Never work with a tool that is not operating properly. Repair works are to be carried out by Paslode Service personnel or its representatives who must be instructed sufficiently about impulse technology to be able to judge a safe working condition of the tool.

# Safety Instructions/Information

GB

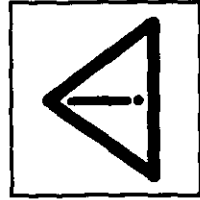

Observe all safety instructions! To avoid injuries to yourself or another person observe also the specific operating manual and service instructions for your tool.

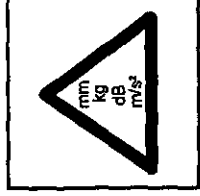

For technical data, sound— and vibration values, information about fuel cell, battery and recharger, specified consumables please see your operating manual and ITW Paslode technical data sheet.



Only use fasteners, battery, fuel cell, battery charger and spare parts as specified in the tool data sheet. Paslode shall in no event be liable by nonobservation of the instructions. Fasteners are to be used only with timber-to-timber fixing or materials of similar or lesser density if not otherwise specified.



Do not operate close to flammable materials. Exhaust fumes may get heated up depending on work speed. Observe data about speed of work in tool data sheet.

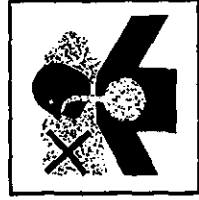

This tool must be operated only in a well ventilated environment. Operation of tool causes exhaust fumes of carbon monoxide which are a danger to health when inhaled.

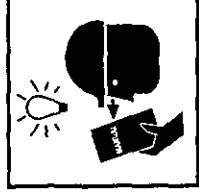

Observe local regulations about storage, handling and transportation of aerosol products (12 bar/50°C). Storage according to TRG300 (D). International transport regulations are established according to ADR/RID; IATA-DGR; IMDG-Code. No mailing!

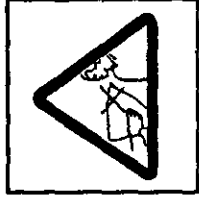

This tool is not a toy. Never assume the tool is empty. Never point the tool at anyone or yourself. Never carry the tool with your finger on the trigger.



Use tool only for the intended application. When tool is ready for operation keep hands away from nosepiece area. Never point nosepiece at yourself or anyone else.



Do not damage housing of tool. No modifications of tool, fuel cell or battery charger are allowed. Do not place tool on oven or radiator, fuel cell in tool might burst. Observe temperature limit of max. 50°C of fuel cell.



Hold the tool in a way to avoid a recoil injuring your head or body. Beware! When working on stairs, ladders, roofs or when nailing crates always take a favourable position to the workpiece.

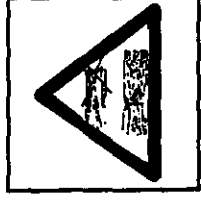

Watch your work place! Fasteners may fire through the work piece and slide sideways through the work piece thus endangering people. Only operate when holding the tool on the work piece.

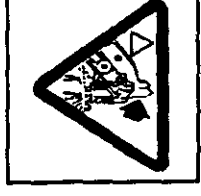

Tools being marked with an upside down equilateral triangle must be used only with a safety yoke. (work contacting element)

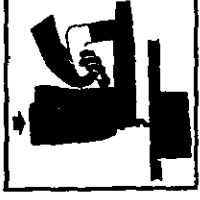

The Impulse nailer should be operated only when it is in contact with the work surface. When fastening thin materials such as plywood, be sure to position the tool so that the fastener is driven into the underlying piece.

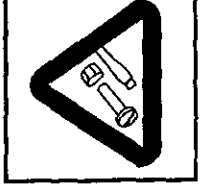

Periodically, check tension of all nuts and bolts on the tools.



Don't smoke when handling fuel cell. Do not inhale its contents. Keep fuel cell valve stem away from face eyes or skin.

**Paslode**

Paslode Division, ITW Ltd.  
Queensway, Fforestfach  
Swansea Sa5 4ED  
GREAT BRITAIN

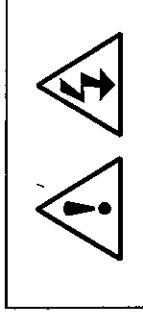

## Safety and Operating Instructions for Impulse Battery and Charging System

### IMPORTANT SAFETY INSTRUCTIONS

- 1) Before using battery charging system, read all instructions and cautionary markings on AC-DC Adapter, Charger Base, and Battery.
- 2) Charging system is designed for indoor use only. Do not expose charging system to rain or excessive moisture.
- 3) Make sure cord is located so that it will not be stepped on, tripped over, or otherwise subjected to damage or stress.
- 4) Do not operate charging system with damaged cord or plug- replace adapter immediately.
- 5) To reduce the risk of personal injury unplug the charging system from the outlet before cleaning the contacts. Clean contacts with a dry brush or equivalent only.
- 6) The charging system and battery are specifically designed to work together. Do not attempt to charge any other cordless tool or battery with this charger.
- 7) Do not attempt to charge Impulse battery with any other charging system, other than the Impulse charging system.
- 8) Do not short a battery. A shorted battery can produce high current which can lead to overheating and burns.
- 9) Do not recharge batteries at a temperature below 40°F (5°C) or above 104°F (40°C).
- 10) Do not allow metal objects to come into contact with battery terminals.
- 11) Do not puncture or attempt to open battery case or cells.
- 12) Do not store battery where it will be subjected to temperatures above 120°F (50°C).
- 13) Do not incinerate battery.
- 14) Do not use a defective battery charger, one that overheats and/or smokes when plugged in.
- 15) Insert and charge only one battery at a time.
- 16) Battery must be recycled or disposed of properly. Battery contains nickel-cadmium cells.

Declaration of Conformity



Paslode declares that this Charger System has been designed in compliance with the Regulations and Standards of 73/23/EEC and 89/336/EEC.

Rudolf Golsch

Paslode International

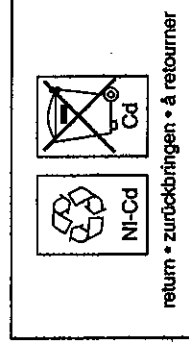

**OPERATING MANUAL**

The Impulse tool comes with a rechargeable battery and its own charging system. This battery and charging system combination is the only one that will work with Impulse tools.

**CHARGING PROCEDURE**

The battery must be charged before making use of a new Impulse Tool. New batteries are shipped discharged and must be charged before use. Each charging of the battery will take 5 minutes to 2 hours, depending on amount of discharge.

**NOTE: OPERATING MANUAL FOR 2 HOUR CHARGING SYSTEM (ORANGE)!**

**IMPORTANT CHARGING NOTES**

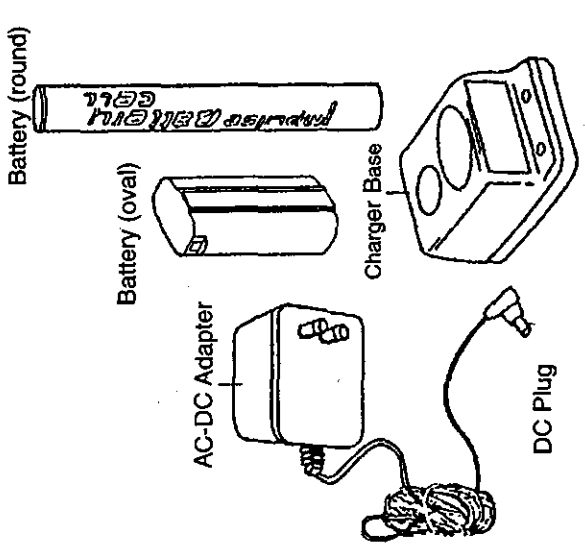
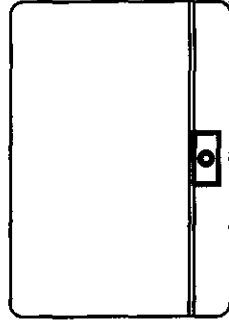
	<p><b>ATTENTION!</b></p> <p><b>CHEMICAL/EXPLOSION HAZARD</b></p> <p>Read all instructions before charging or using battery. Disregard of instructions may result in fire, burns or release of toxic materials.</p>
 <p><b>IMPULSE BATTERY CHARGING SYSTEM</b></p>	
<p><b>REAR VIEW OF CHARGER BASE</b></p>  <p>Plug Receptacle</p>	

**CHARGING INSTRUCTIONS:**

1. Place the round DC plug of the adapter into the plug receptacle on the back of the orange charger base. Insert the adapter into the electric current outlet as specified in table below. A green light indicates power is on and charger is ready for use.
2. Insert battery with terminals down into charger base. Charge one battery only at a time  
**Red light indicates that battery is charging.**  
 The green light will turn off.

**Please Note!**

If battery is completely discharged, the red and green lights may flash back and forth for up to 20 minutes. This safety feature slowly recharges the battery until it is ready to accept the full charging current. If the lights continue to flash after 20 minutes, replace the battery.

3. **After charging, the red light will turn off and the green light will come on, indicating that the battery is fully charged.**  
 The battery is ready for use!
4. After charging is completed unplug DC plug and adapter.

**CHARGING TIMES FOR BATTERY:**

- First Charge 2 Hours
- Partially Charged Battery - 5 Min. to 2 Hours
- Completely Discharged Battery 2 Hours

**TECHNICAL DATA**

**Impulse Adapter(AC-DC)**

- Europe
- Great Britain
- Australia
- USA/Canada

**Impulse Charger Base**

**Impulse Battery**

- 6VDC, 1300mAh, Nickel-cadmium
- Battery round
- Battery oval

Part No.	Input	Output	Polarity
900505	230V, 50HZ	12VDC, 800mA	⊕ ⊖
900506	240V, 50Hz	12VDC, 800mA	⊖ ⊕
900504	240V, 50HZ	12VDC, 800mA	⊖ ⊕
900477	120V, 60HZ	12VDC, 800mA	⊖ ⊕
900476	12VDC, 9.6VA	6VDC, 4.5VA	
402500	IM200, IM250, IM300, IM325, IM350		(black)
404717	IM250II, IM325CT, IM350CT		(orange)

# PASLODE IMPULSE FUEL CELLS

Chemwatch Independent Material Safety Data Sheet

Issue Date: 28-Jul-2008

NC317ECP

CHEMWATCH 4919-89

Version No:8

CD 2010/1 Page 1 of 11

## Section 1 - CHEMICAL PRODUCT AND COMPANY IDENTIFICATION

**PRODUCT NAME**  
PASLODE IMPULSE FUEL CELLS

**SYNONYMS**  
"nail gun fuel supply"

**PROPER SHIPPING NAME**  
FUEL CELL CARTRIDGES or FUEL CELL CARTRIDGES CONTAINED IN EQUIPMENT or FUEL CELL CARTRIDGES IN EQUIPMENT, containing liquefied flammable gas

**PRODUCT USE**  
Fuel supply for Paslode nail guns.

**SUPPLIER**  
Company: Paslode Australia Pty  
Address:  
47- 55 Williamson Road  
Ingleburn  
NSW, 2565  
AUS  
Telephone: +61 2 9829 4000  
Fax: +61 2 9829 7788

## Section 2 - HAZARDS IDENTIFICATION

**STATEMENT OF HAZARDOUS NATURE**  
DANGEROUS GOODS. NON-HAZARDOUS SUBSTANCE. According to NOHSC Criteria, and ADG Code.

**POISONS SCHEDULE**  
None

**RISK**

- Extremely flammable.
- Risk of explosion if heated under confinement.

**SAFETY**

- Keep away from sources of ignition. No smoking.
- Do not breathe gas/ fumes/ vapour/ spray.
- Avoid contact with skin.
- Use only in well ventilated areas.
- Keep container in a well ventilated place.
- Keep container tightly closed.
- This material and its container must be disposed of as hazardous waste.

## Section 3 - COMPOSITION / INFORMATION ON INGREDIENTS

NAME	CAS RN	%
fuel nonhazardous proprietary propellant, as propylene	115-07-1	>60
NOTE: Manufacturer has supplied full ingredient information to allow CHEMWATCH assessment.	1-10	1-10

continued...

# PASLODE IMPULSE FUEL CELLS

Chemwatch Independent Material Safety Data Sheet

Issue Date: 28-Jul-2008

NC317ECP

CHEMWATCH 4919-89

Version No:8

CD 2010/1 Page 2 of 11

## Section 3 - COMPOSITION / INFORMATION ON INGREDIENTS

### Section 4 - FIRST AID MEASURES

#### SWALLOWED

- - If swallowed do NOT induce vomiting.
- If vomiting occurs, lean patient forward or place on left side (head-down position, if possible) to maintain open airway and prevent aspiration.
- Observe the patient carefully.
- Never give liquid to a person showing signs of being sleepy or with reduced awareness; i.e. becoming unconscious.
- Give water to rinse out mouth, then provide liquid slowly and as much as casualty can comfortably drink.
- Seek medical advice.

#### EYE

- If this product comes in contact with the eyes:
  - Wash out immediately with fresh running water.
  - Ensure complete irrigation of the eye by keeping eyelids apart and away from eye and moving the eyelids by occasionally lifting the upper and lower lids.
  - Seek medical attention without delay; if pain persists or recurs seek medical attention.
  - Removal of contact lenses after an eye injury should only be undertaken by skilled personnel.

#### SKIN

- If skin or hair contact occurs:
  - Flush skin and hair with running water (and soap if available).
  - Seek medical attention in event of irritation.

#### INHALED

- - If fumes or combustion products are inhaled remove from contaminated area.
- Lay patient down. Keep warm and rested.
- Prosthesis such as false teeth, which may block airway, should be removed, where possible, prior to initiating first aid procedures.
- Apply artificial respiration if not breathing, preferably with a demand valve resuscitator, bag-valve mask device, or pocket mask as trained. Perform CPR if necessary.
- Transport to hospital, or doctor.

#### NOTES TO PHYSICIAN

- For acute or short term repeated exposures to petroleum distillates or related hydrocarbons:
  - Primary threat to life, from pure petroleum distillate ingestion and/or inhalation, is respiratory failure.
  - Patients should be quickly evaluated for signs of respiratory distress (e.g. cyanosis, tachypnoea, intercostal retraction, obtundation) and given oxygen. Patients with inadequate tidal volumes or poor arterial blood gases (pO<sub>2</sub> 50 mm Hg) should be intubated.
  - Arrhythmias complicate some hydrocarbon ingestion and/or inhalation and electrocardiographic evidence of myocardial injury has been reported; intravenous lines and cardiac monitors should be established in obviously symptomatic patients. The lungs excrete inhaled solvents, so that hyperventilation improves clearance.
  - A chest x-ray should be taken immediately after stabilisation of breathing and circulation to document aspiration and detect the presence of pneumothorax.
  - Epinephrine (adrenalin) is not recommended for treatment of bronchospasm because of potential myocardial sensitisation to catecholamines. Inhaled cardioselective bronchodilators (e.g. Alupent, Salbutamol) are the preferred agents, with aminophylline a second choice.
  - Lavage is indicated in patients who require decontamination; ensure use of cuffed endotracheal tube in adult patients. [Ellenhorn and Barceloux: Medical Toxicology].

continued...

# PASLODE IMPULSE FUEL CELLS

Chemwatch Independent Material Safety Data Sheet

Issue Date: 28-Jul-2008

NC317ECP

CHEMWATCH 4919-89

Version No:8

CD 2010/1 Page 3 of 11

## Section 5 - FIRE FIGHTING MEASURES

### EXTINGUISHING MEDIA

- - Water spray or fog.
- Foam.
- Dry chemical powder.
- BCF (where regulations permit).
- Carbon dioxide.

### FIRE FIGHTING

- - Alert Fire Brigade and tell them location and nature of hazard.
- May be violently or explosively reactive.
- Wear breathing apparatus plus protective gloves.
- Prevent, by any means available, spillage from entering drains or water course.
- If safe, switch off electrical equipment until vapour fire hazard removed.
- Use water delivered as a fine spray to control fire and cool adjacent area.
- DO NOT approach containers suspected to be hot.
- Cool fire exposed containers with water spray from a protected location.
- If safe to do so, remove containers from path of fire.
- Equipment should be thoroughly decontaminated after use.

### FIRE/EXPLOSION HAZARD

- - Liquid and vapour are highly flammable.
- Severe fire hazard when exposed to heat, flame and/or oxidisers.
- Vapour forms an explosive mixture with air.
- Severe explosion hazard, in the form of vapour, when exposed to flame or spark.
- Vapour may travel a considerable distance to source of ignition.
- Heating may cause expansion / decomposition with violent rupture of containers.
- On combustion, may emit toxic fumes of carbon monoxide (CO).  
Other combustion products include: carbon dioxide (CO<sub>2</sub>).

### FIRE INCOMPATIBILITY

- Avoid contamination with strong oxidising agents as ignition may result.

### HAZCHEM

2Y\*

### Personal Protective Equipment

Gas tight chemical resistant suit.

## Section 6 - ACCIDENTAL RELEASE MEASURES

### MINOR SPILLS

- - Clean up all spills immediately.
- Avoid breathing vapours and contact with skin and eyes.
- Wear protective clothing, impervious gloves and safety glasses.
- Shut off all possible sources of ignition and increase ventilation.
- Wipe up.
- If safe, damaged cans should be placed in a container outdoors, away from all ignition sources, until pressure has dissipated.
- Undamaged cans should be gathered and stowed safely.

### MAJOR SPILLS

- - Clear area of personnel and move upwind.
- Alert Fire Brigade and tell them location and nature of hazard.
- May be violently or explosively reactive.

continued...

# PASLODE IMPULSE FUEL CELLS

Chemwatch Independent Material Safety Data Sheet

Issue Date: 28-Jul-2008

NC317ECP

CHEMWATCH 4919-89  
Version No:8

CD 2010/1 Page 4 of 11

## Section 6 - ACCIDENTAL RELEASE MEASURES

- Wear breathing apparatus plus protective gloves.
- Prevent, by any means available, spillage from entering drains or water courses
- No smoking, naked lights or ignition sources.
- Increase ventilation.
- Stop leak if safe to do so.
- Water spray or fog may be used to disperse / absorb vapour.
- Absorb or cover spill with sand, earth, inert materials or vermiculite.
- If safe, damaged cans should be placed in a container outdoors, away from ignition sources, until pressure has dissipated.
- Undamaged cans should be gathered and stowed safely.
- Collect residues and seal in labelled drums for disposal.

Personal Protective Equipment advice is contained in Section 8 of the MSDS.

## Section 7 - HANDLING AND STORAGE

### PROCEDURE FOR HANDLING

- Remove all ignition sources.
- Limit all unnecessary personal contact.
- Wear protective clothing when risk of exposure occurs.
- Use in a well-ventilated area.
- When handling DO NOT eat, drink or smoke.
- Always wash hands with soap and water after handling.
- Avoid physical damage to containers.
- Use good occupational work practice.
- Observe manufacturer's storing and handling recommendations.

### SUITABLE CONTAINER

Fuel cell cartridge.

### STORAGE INCOMPATIBILITY

- Avoid storage with oxidisers.

### STORAGE REQUIREMENTS

- - Store in original containers in approved flame-proof area.
- DO NOT store in pits, depressions, basements or areas where vapours may be trapped.
- No smoking, naked lights, heat or ignition sources.
- Keep containers securely sealed. Contents under pressure.
- Store away from incompatible materials.
- Store in a cool, dry, well ventilated area in an upright position.
- Avoid storage at temperatures higher than 40 deg C.
- Protect containers against physical damage and check regularly for leaks.
- Observe manufacturer's storing and handling recommendations.

## Section 8 - EXPOSURE CONTROLS / PERSONAL PROTECTION

### EXPOSURE CONTROLS

#### MATERIAL DATA

PASLODE IMPULSE FUEL CELLS:

Not available

#### PROPYLENE:

- May act as a simple asphyxiant; these are gases which, when present in high concentrations, reduce the

continued...

# PASLODE IMPULSE FUEL CELLS

Chemwatch Independent Material Safety Data Sheet

Issue Date: 28-Jul-2008

NC317ECP

CHEMWATCH 4919-89

Version No:8

CD 2010/1 Page 5 of 11

## Section 8 - EXPOSURE CONTROLS / PERSONAL PROTECTION

oxygen content in air below that required to support breathing, consciousness and life; loss of consciousness, with death by suffocation may rapidly occur in an oxygen deficient atmosphere.

**CARE:** Most simple asphyxiants are odourless or possess low odour and there is no warning on entry into an oxygen deficient atmosphere. If there is any doubt, oxygen content can be checked simply and quickly. It may not be appropriate to only recommend an exposure standard for simple asphyxiants rather it is essential that sufficient oxygen be maintained. Air normally has 21 percent oxygen by volume, with 18 percent regarded as minimum under normal atmospheric pressure to maintain consciousness / life. At pressures significantly higher or lower than normal atmospheric pressure, expert guidance should be sought.

**NOTE:** This substance has been classified by the ACGIH as A4 NOT classifiable as causing Cancer in humans.

### PERSONAL PROTECTION

#### EYE

- No special equipment for minor exposure i.e. when handling small quantities.
- OTHERWISE:
  - Safety glasses with side shields.
  - Contact lenses may pose a special hazard; soft contact lenses may absorb and concentrate irritants. A written policy document, describing the wearing of lens or restrictions on use, should be created for each workplace or task. This should include a review of lens absorption and adsorption for the class of chemicals in use and an account of injury experience. Medical and first-aid personnel should be trained in their removal and suitable equipment should be readily available. In the event of chemical exposure, begin eye irrigation immediately and remove contact lens as soon as practicable. Lens should be removed at the first signs of eye redness or irritation - lens should be removed in a clean environment only after workers have washed hands thoroughly. [CDC NIOSH Current Intelligence Bulletin 59].

#### HANDS/FEET

- - No special equipment needed when handling small quantities.
- OTHERWISE: Wear general protective gloves, eg. light weight rubber gloves. Or as required: Wear chemical protective gloves, eg. PVC. Wear safety footwear.

#### OTHER

- No special equipment needed when handling small quantities.

#### OTHERWISE:

- Overalls.
- Barrier cream.
- Eyewash unit.

The local concentration of material, quantity and conditions of use determine the type of personal protective equipment required. For further information consult site specific CHEMWATCH data (if available), or your Occupational Health and Safety Advisor.

### ENGINEERING CONTROLS

- General exhaust is adequate under normal operating conditions. If risk of overexposure exists, wear SAA approved respirator. Correct fit is essential to obtain adequate protection. Provide adequate ventilation in warehouse or closed storage areas.

## Section 9 - PHYSICAL AND CHEMICAL PROPERTIES

### APPEARANCE

Compressed highly flammable liquified gas.

### PHYSICAL PROPERTIES

Liquid.

Gas.

Does not mix with water.

continued...

# PASLODE IMPULSE FUEL CELLS

Chemwatch Independent Material Safety Data Sheet  
Issue Date: 28-Jul-2008  
NC317ECP

CHEMWATCH 4919-89  
Version No:8  
CD 2010/1 Page 6 of 11

## Section 9 - PHYSICAL AND CHEMICAL PROPERTIES

Floats on water.

State	Liquid	Molecular Weight	Not applicable
Melting Range (°C)	Not Available	Viscosity	Not Applicable
Boiling Range (°C)	Not Available	Solubility in water (g/L)	Partly miscible
Flash Point (°C)	- 108	pH (1% solution)	Not applicable
Decomposition Temp (°C)	Not Available	pH (as supplied)	Not applicable
Autoignition Temp (°C)	Not Available	Vapour Pressure (kPa)	Not available
Upper Explosive Limit (%)	Not Available	Specific Gravity (water=1)	0.7
Lower Explosive Limit (%)	Not Available	Relative Vapour Density (air=1)	>1
Volatile Component (%vol)	100	Evaporation Rate	Not available

## Section 10 - CHEMICAL STABILITY AND REACTIVITY INFORMATION

### CONDITIONS CONTRIBUTING TO INSTABILITY

- - Elevated temperatures.
  - Presence of open flame.
  - Product is considered stable.
  - Hazardous polymerisation will not occur.
- For incompatible materials - refer to Section 7 - Handling and Storage.*

## Section 11 - TOXICOLOGICAL INFORMATION

### POTENTIAL HEALTH EFFECTS

#### ACUTE HEALTH EFFECTS

##### SWALLOWED

- Considered an unlikely route of entry in commercial/industrial environments. Not normally a risk due to extreme volatility of liquid.

##### EYE

- The gas is non-irritating to the eyes but may cause severe cold burns.

##### SKIN

- Vapourising liquid causes rapid cooling and contact may cause cold burns, frostbite, even through normal gloves. Frozen skin tissues are painless and appear waxy and yellow. Signs and symptoms of frost-bite may include "pins and needles", paleness followed by numbness, a hardening or stiffening of the skin, a progression of colour changes in the affected area, (first white, then mottled and blue and eventually black; on recovery, red, hot, painful and blistered).

##### INHALED

- The vapour is a simple asphyxiant (precludes access to oxygen). Acute effects from inhalation of high concentrations of gas/vapour are pulmonary irritation, including coughing, with nausea; central nervous system depression - characterised by headache and dizziness, increased reaction time, fatigue and loss of co-ordination.

**WARNING:** Intentional misuse by concentrating/inhaling contents may be lethal. Not considered an irritant through normal use. Inhalation may cause cardiac sensitisation.

##### CHRONIC HEALTH EFFECTS

- Primary route of exposure is usually by inhalation of the gas. As with any chemical product, contact with unprotected bare skin; inhalation of vapour, mist or dust in work place atmosphere; or ingestion in any form, should be avoided by observing good occupational work practice.

continued...

# PASLODE IMPULSE FUEL CELLS

Chemwatch Independent Material Safety Data Sheet  
Issue Date: 28-Jul-2008  
NC317ECP

CHEMWATCH 4919-89  
Version No:8  
CD 2010/1 Page 7 of 11  
Section 11 - TOXICOLOGICAL INFORMATION

## TOXICITY AND IRRITATION

- Not available. Refer to individual constituents.

## PROPYLENE:

- unless otherwise specified data extracted from RTECS - Register of Toxic Effects of Chemical Substances.

- No significant acute toxicological data identified in literature search.  
The substance is classified by IARC as Group 3:

NOT classifiable as to its carcinogenicity to humans.

Evidence of carcinogenicity may be inadequate or limited in animal testing.

## CARCINOGEN

Propylene

International Agency  
for Research on Cancer  
(IARC) - Agents  
Reviewed by the IARC  
Monographs

3

## Section 12 - ECOLOGICAL INFORMATION

Refer to data for ingredients, which follows:

### PROPYLENE:

#### PASLODE IMPULSE FUEL CELLS:

- DO NOT discharge into sewer or waterways.

#### PASLODE IMPULSE FUEL CELLS:

Marine Pollutant: Not Determined

### PROPYLENE:

- log Kow (Prager 1995): 1.77
- Half-life Soil - High (hours): 672
- Half-life Soil - Low (hours): 168
- Half-life Air - High (hours): 13.7
- Half-life Air - Low (hours): 1.7
- Half-life Surface water - High (hours): 672
- Half-life Surface water - Low (hours): 168
- Half-life Ground water - High (hours): 1344
- Half-life Ground water - Low (hours): 336
- Aqueous biodegradation - Aerobic - High (hours): 672
- Aqueous biodegradation - Aerobic - Low (hours): 168
- Aqueous biodegradation - Anaerobic - High (hours): 2688
- Aqueous biodegradation - Anaerobic - Low (hours): 672
- Photooxidation half-life water - High (hours): 43000
- Photooxidation half-life water - Low (hours): 1070
- Photooxidation half-life air - High (hours): 13.7
- Photooxidation half-life air - Low (hours): 1.7

- Substances containing unsaturated carbons are ubiquitous in indoor environments. They result from many sources (see below). Most are reactive with environmental ozone and many produce stable products which are thought to adversely affect human health. The potential for surfaces in an enclosed space to facilitate reactions should be considered.

continued...

# PASLODE IMPULSE FUEL CELLS

Chemwatch Independent Material Safety Data Sheet

Issue Date: 28-Jul-2008

NC317ECP

CHEMWATCH 4919-89

Version No:8

CD 2010/1 Page 8 of 11

## Section 12 - ECOLOGICAL INFORMATION

Source of unsaturated substances	Unsaturated substances (Reactive Emissions)	Major Stable Products produced following reaction with ozone.
Occupants (exhaled breath, ski oils, personal care products)	Isoprene, nitric oxide, squalene, unsaturated sterols, oleic acid and other unsaturated fatty acids, unsaturated oxidation products	Methacrolein, methyl vinyl ketone, nitrogen dioxide, acetone, 6MHQ, geranyl acetone, 4OPA, formaldehyde, nonanal, decanal, 9-oxo- nonanoic acid, azelaic acid, nonanoic acid.
Soft woods, wood flooring, including cypress, cedar and silver fir boards, houseplants	Isoprene, limonene, alpha-pinene, other terpenes and sesquiterpenes	Formaldehyde, 4- AMC, pinoaldehyde, pinic acid, pinonic acid, formic acid, methacrolein, methyl vinyl ketone, SOAs including ultrafine particles
Carpets and carpet backing	4- Phenylcyclohexene, 4-vinylcyclohexene, styrene, 2-ethylhexyl acrylate, unsaturated fatty acids and esters	Formaldehyde, acetaldehyde, benzaldehyde, hexanal, nonanal, 2- nonenal
Linoleum and paints/polishes containing linseed oil	Linoleic acid, linolenic acid	Propanal, hexanal, nonanal, 2-heptenal, 2- nonenal, 2-decenal, 1- pentene- 3- one, propionic acid, n- butyric acid
Latex paint	Residual monomers	Formaldehyde
Certain cleaning products, polishes, waxes, air fresheners	Limonene, alpha- pinene, terpinolene, alpha- terpineol, linalool, linalyl acetate and other terpenoids, longifolene and other sesquiterpenes	Formaldehyde, acetaldehyde, glycoaldehyde, formic acid, acetic acid, hydrogen and organic peroxides, acetone, benzaldehyde, 4- hydroxy- 4- methyl- 5- hexen- 1- al, 5- ethenyl- dihydro- 5- methyl- 2(3H)- furanone, 4- AMC, SOAs including ultrafine particles
Natural rubber adhesive	Isoprene, terpenes	Formaldehyde, methacrolein, methyl vinyl ketone
Photocopier toner, printed paper, styrene polymers	Styrene	Formaldehyde, benzaldehyde
Environmental tobacco smoke	Styrene, acrolein, nicotine	hexanal, glyoxal, N-methylformamide, nicotinaldehyde, cotinine
Soiled clothing, fabrics, bedding	Squalene, unsaturated sterols, oleic acid and other saturated fatty acids	Acetone, geranyl acetone, 6MHO, 40PA, formaldehyde, nonanal, decanal, 9- oxo- nonanoic acid, azelaic acid, nonanoic acid
Soiled particle filters	Unsaturated fatty acids from plant waxes, leaf litter, and other vegetative debris; soot; diesel particles	Formaldehyde, nonanal, and other aldehydes; azelaic acid; nonanoic acid; 9- oxo- nonanoic acid and other oxo- acids; compounds with mixed functional groups (=O, - OH, and - COOH) C5 to C10 aldehydes
Ventilation ducts and duct liners	Unsaturated fatty acids and esters, unsaturated oils, neoprene	
" Urban grime"	Polycyclic aromatic hydrocarbons	Oxidized polycyclic aromatic hydrocarbons

continued...

# PASLODE IMPULSE FUEL CELLS

Chemwatch Independent Material Safety Data Sheet

Issue Date: 28-Jul-2008

NC317ECP

CHEMWATCH 4919-89

Version No:8

CD 2010/1 Page 9 of 11

## Section 12 - ECOLOGICAL INFORMATION

Perfumes, colognes, essential oils (e.g. lavender, eucalyptus, tea tree)

Limonene, alpha- pinene, linalool, linalyl acetate, terpinene- 4- ol, gamma- terpinene

Overall home emissions

Limonene, alpha- pinene, styrene

Formaldehyde, 4- AMC, acetone, 4- hydroxy- 4- methyl- 5- hexen- 1- al, 5- ethenyl- dihydro- 5- methyl- 2(3H) furanone, SOAs including ultrafine particles  
Formaldehyde, 4- AMC, pinonaldehyde, acetone, pinic acid, pinonic acid, formic acid, benzaldehyde, SOAs including ultrafine particles

Abbreviations: 4-AMC, 4-acetyl-1-methylcyclohexene; 6MHQ, 6-methyl-5-heptene-2-one, 4OPA, 4-oxopentanal, SOA, Secondary Organic Aerosols

Reference: Charles J Weschler; Environmental Health Perspectives, Vol 114, October 2006.

■ For propene:

Koc : 219-237

Half-life (hr) air : 7.7

BCF : 13-31

Fish:LC50 (96 h): 8.4-9.6 mg/L

Invertebrate LC50 (96 h): 1.8-13 mg/L

Degradation Biological: significant

Abiotic processes: photodecomposes.

### Ecotoxicity

Ingredient

propylene

Persistence:

Water/Soil

LOW

Persistence: Air

LOW

Bioaccumulation

LOW

Mobility

## Section 13 - DISPOSAL CONSIDERATIONS

- - Recycle wherever possible or consult manufacturer for recycling options.
- Consult State Land Waste Management Authority for disposal.
- Bury residue in an authorised landfill.
- Recycle containers if possible, or dispose of in an authorised landfill.

## Section 14 - TRANSPORTATION INFORMATION

Labels Required: FLAMMABLE GAS

### HAZCHEM:

2Y\* (ADG7)

### ADG7:

Class or division: 2.1

UN No.: 3478

Special provisions: 328; 338

Limited quantities: 120 ml

Subsidiary risk: None  
UN packing group: None  
Packing Instructions: None  
Portable tanks and bulk containers - None

Instructions:

Packagings and IBCs - P004

Portable tanks and bulk containers - Special

provisions:

Packagings and IBCs - None

Special packing

provisions:

Shipping Name:FUEL CELL CARTRIDGES or FUEL CELL CARTRIDGES CONTAINED

continued...



# PASLODE IMPULSE FUEL CELLS

Chemwatch Independent Material Safety Data Sheet

Issue Date: 28-Jul-2008

NC317ECP

CHEMWATCH 4919-89

Version No:8

CD 2010/1 Page 11 of 11

Section 16 - OTHER INFORMATION

*This is the end of the MSDS.*