

SCANNED

738

HITACHI

2702001

Plant No. 2702001

Drill

Drill 2 Stroke Keyless Chuck

DW25EF (SR)

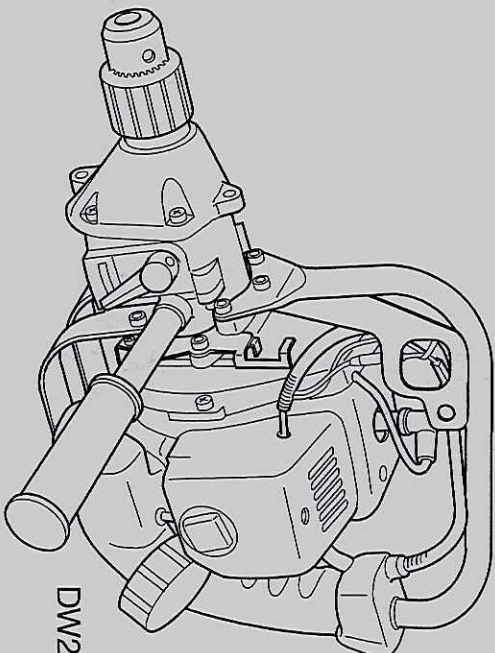

DW25EF (SR)

Read the manual carefully before operating this machine.



Handling instructions

Hitachi Koki



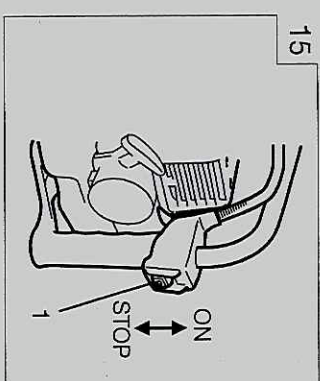
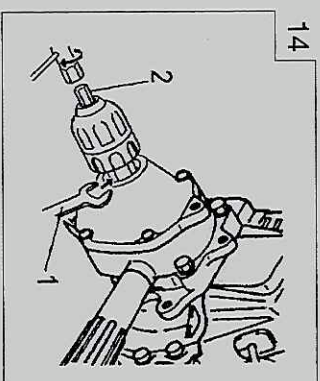
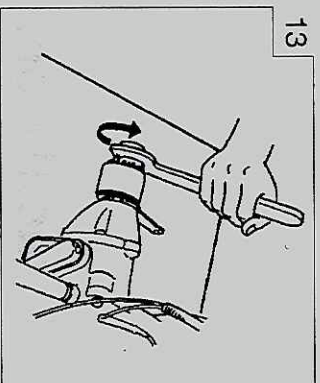
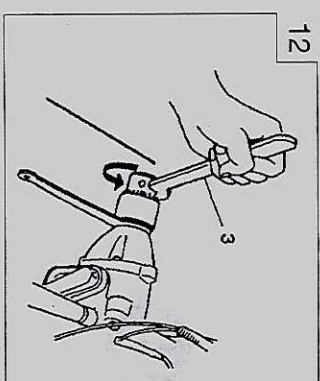
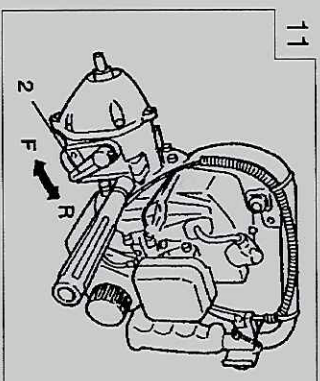
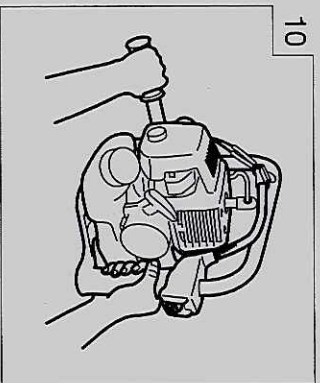
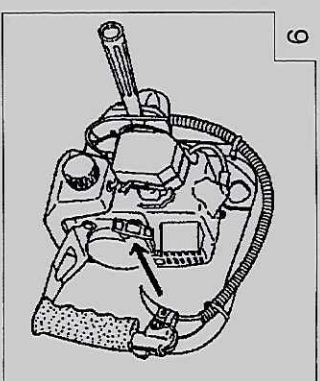
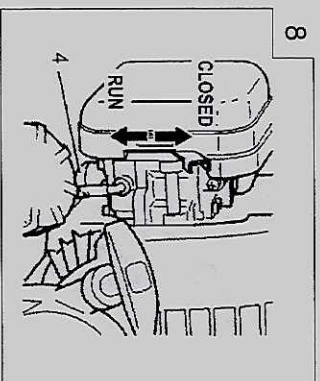
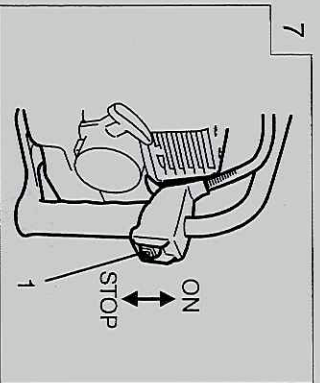
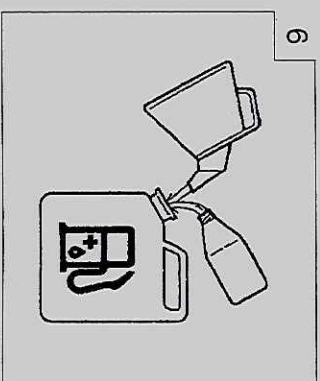
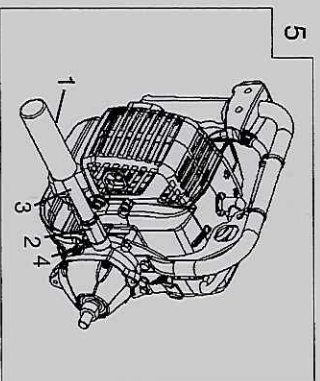
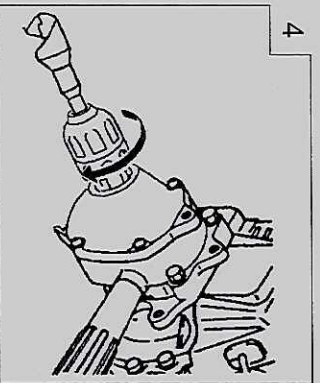
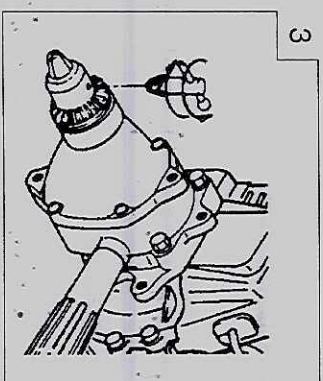
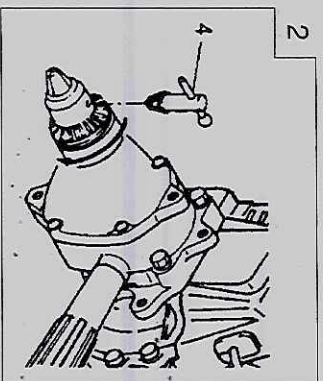
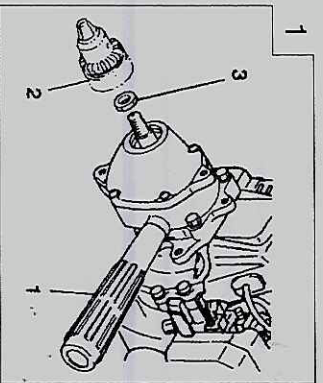

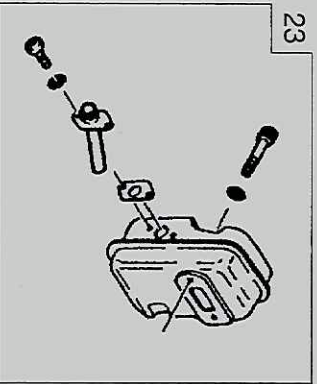
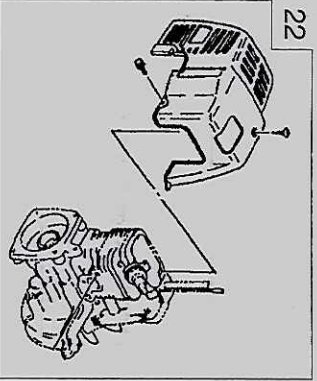
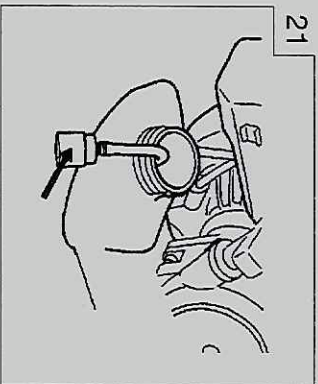
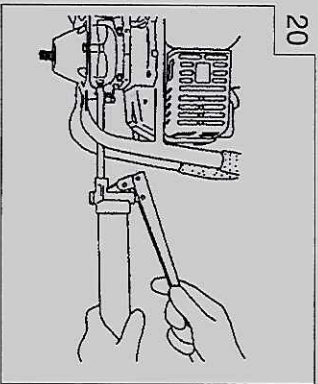
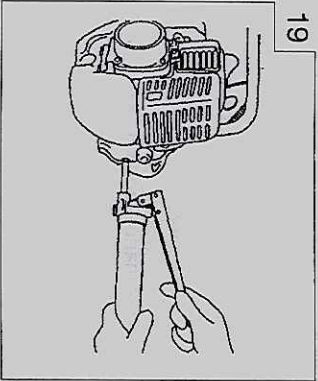
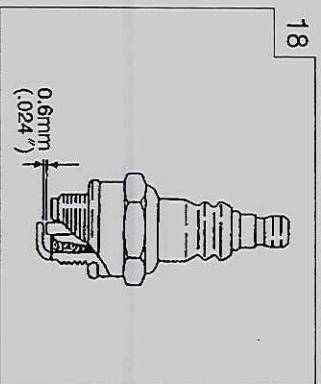
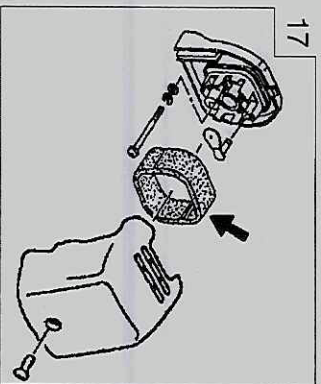
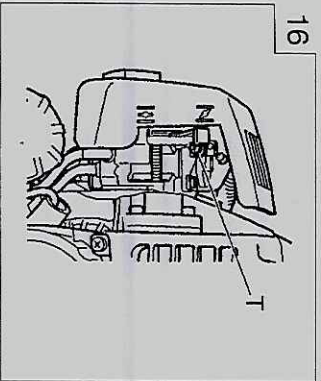

970-81048-200 2008.10



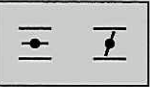

Meanings of symbols.

NOTE! Some units do not carry them

	<p>symbols  WARNING The engine exhaust from this product contains chemicals known to the State of California to cause cancer, birth defects and other reproductive harm.</p>
	<p>It is important that you read, fully understand and observe the following safety precautions and warnings. Careless or improper use of the unit may cause serious or fatal injury.</p>
	<p>Read, understand and follow all warnings and instructions in this manual and on the unit.</p>
	<p>Always wear eye, head and ear protectors when using this unit.</p>
	<p>Explains choke position. Upper sign indicates choke closed and the lower fully open.</p>
 <p>Do not touch the bit when running the engine.</p>	<p>Do not touch the bit when running the engine.</p>
<p>Before using your machine</p> <ul style="list-style-type: none"> • Read the manual carefully. • Check that the cutting equipment is correctly assembled and adjusted. • Start the unit and check the carburetor adjustment. See "Maintenance". 	

Index

What is what? 2

Warnings and safety instructions 3

Specifications 4

Assembly procedures..... 5

Operating procedures 5

Maintenance..... 5

What is what?

Since this manual covers several models, there may be some difference between pictures and your unit. Use the instructions that apply to your unit.

1. Handle
2. Plug cap
3. Ignition switch
4. Muffler
5. Chuck unit
6. Throttle trigger
7. Gear case
8. Fuel cap
9. Fuel tank
10. Shift lever
11. Air cleaner
12. Hole for strap
13. Combi box spanner
14. Handling instructions

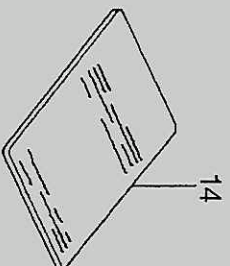
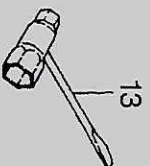
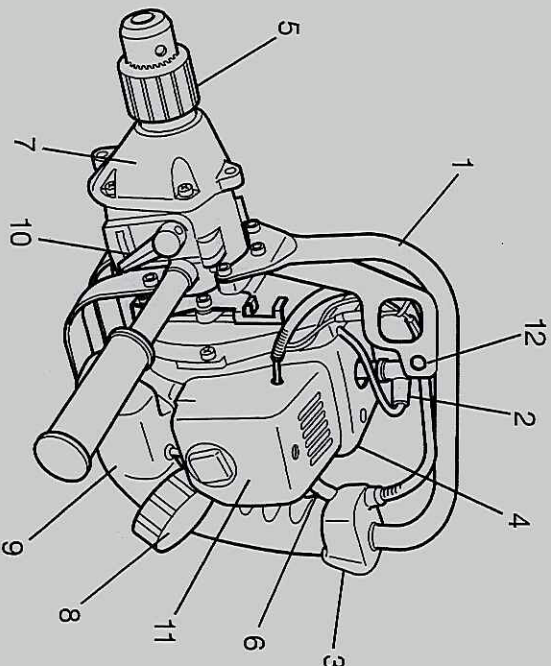

Warnings and safety instructions

Operator safety

- Always wear a safety face shield or goggles.
- Always wear heavy, long pants, boots and gloves. Do not wear loose clothing, jewelry, short pants, sandals or go barefoot. Secure hair so it is above shoulder length.
- Do not operate this unit/machine when you are tired, ill or under the influence of alcohol, drugs or medication.
- Never let a child or inexperienced person operate the machine.
- Wear hearing protection.
- Never start or run the engine inside a closed room or building. Breathing exhaust fumes can kill.
- Keep hands free of oil and fuel.
- Keep hands away from drilling equipment.
- Do not grab or hold the unit by the drilling equipment.
- When the unit is turned off, make sure the drilling attachment has stopped before the unit is set down.
- When operation is prolonged, take a break from time to time so that you may avoid possible whitefinger disease which is caused by vibration.

Unit / machine safety

- Inspect the entire unit/machine before each use. Replace damaged parts. Check for fuel leaks and make sure all fasteners are in place and securely tightened.
- Replace parts that are cracked, chipped or damaged in any way before using the unit/machine.
- Keep others away when making carburetor adjustments.
- Use only accessories as recommended for this unit/machine by the manufacturer.

⚠ WARNING!

Never modify the unit/machine in any way. Do not use your drilling tool for any job except that for which it is intended.

Fuel safety

- Mix and pour fuel outdoors and where there are no sparks or flames.
- Use a container approved for fuel.
- Do not smoke or allow smoking near fuel or the unit/machine or while using the unit/machine.
- Wipe up all fuel spills before starting engine.
- Move at least 3 m away from fueling site before starting engine. Stop engine before removing fuel cap.
- Empty the fuel tank before storing the unit/machine. It is recommended that the fuel be emptied after each use. If fuel is left in the tank, store so fuel will not leak.
- Store unit/machine and fuel in area where fuel vapors cannot reach sparks or open flames from water heaters, electric motors or switches, furnaces, etc.

⚠ WARNING!

Antivibration systems do not guarantee that you will not sustain whitefinger disease or carpal tunnel syndrome. Therefore, continual and regular users should monitor closely the condition of their hands and fingers. If any of the above symptoms appear, seek medical advice immediately.

Drilling safety

- Do not drill any material other than that for which is intended.
- Inspect the area to be drilled before each use. Remove objects which can be thrown or become entangled.
- For respiratory protection, wear an aerosol protection mask when drilling the area after insecticide is scattered.
- Keep others including children, animals, bystanders and helpers outside the 5 m hazard zone. Stop the engine immediately if you are approached.
- Hold the unit/machine firmly with both hands.
- Keep firm footing and balance. Do not over-reach.
- Keep all parts of your body away from the muffler and drilling attachment when the engine is running.

Maintenance safety

- Maintain the unit/machine according to recommended procedures.
- Disconnect the spark plug before performing maintenance except for carburetor adjustments.
- Keep others away when making carburetor adjustments.
- Use only genuine HITACHI replacement parts as recommended by the manufacturer.

Transport and storage

- Carry the unit/machine by hand with the engine stopped and the muffler away from your body.
- Allow the engine to cool, empty the fuel tank, and secure the unit/machine before storing or transporting in a vehicle.
- Empty the fuel tank before storing the unit/machine. It is recommended that the fuel be emptied after each use. If fuel is left in the tank, store so fuel will not leak.
- Store unit/machine out of the reach of children.
- Clean and maintenance the unit carefully and store it in a dry place.
- Make sure engine switch is off when transporting or storing.
- When transporting in a vehicle, cover bit with bit cover or rug.

If situations occur which are not covered in this manual, take care and use. Contact HITACHI dealer if you need assistance. Pay special attention to statements preceded by the following words:

⚠ WARNING!

Indicates a strong possibility of severe personal injury or loss of life, if instructions are not followed.









CAUTION!

Indicates a possibility of personal injury or equipment damage, if instructions are not followed.

NOTE!

Helpful information for correct function and use.

Specifications

MODEL	DW25EF (SR)
 Engine Size (mℓ)	26.9 (1.64 cu. in.)
 Spark Plug	Champion RCJ8Y or equivalent
 Fuel Tank Capacity (ℓ)	0.67 (22.8 fl. oz)
 Dry Weight (kg)	5.4 (11.9 lbs)
 Chuck Capacity (mm)	12.7 (1/2 in)
Drive Shaft Diameter	1/2"-20 UNF
 Max. Bit Size (mm) (Wood)	25.4 (1 in)
Reverse Control	○
Lock Control	
 Sound pressure level LpA (dB(A)) (EN 27917)	91.2
 Sound power level LwA (dB(A))	116
 Vibration level (m/s ²) (ISO 7916) Front handle Rear handle	71 72

NOTE : Equivalent noise level/vibration level are calculated as the time-weighted energy total for noise/vibration levels under various working conditions with the following time distribution : 1/2 idle, 1/2 racing.
*All data subject to change without notice.

Assembly procedures

- Assembling (Fig. 1, 2, 3)
1. Assemble the handle (1) which is supplied with the unit to the gear case.
 2. Screw the chuck unit (2) into the drive shaft (clockwise) after the collar B (3) has been installed. (if so equipped)
 3. Insert the drill bit to be used after opening the chuck by the chuck handle (4) and tighten the chuck by the handle.

NOTE!

If the keylesschuck is equipped, loosen chuck and insert drill bit. Then tighten chuck by turning clockwise till making "click" noise (Fig. 4)

Selection of a Suitable Bit

Choose a drill bit according to material to be drilled.

In case of assembly the handle (1) at the muffler side, install the S.washer (10 (4), adapter (2) to the gear case and then assemble the handle to the adapter. (Fig. 5)

⚠ WARNING!

If the handle is mounted at the muffler side, the handle bar (3) will get hot by exhaust gas. Never touch the handle bar until cooling down, otherwise serious personal injury may occur.

Operating procedures

Fuel (Fig. 6)

⚠ WARNING!

The power drill is equipped with a two-stroke engine. Always run the engine on fuel, which is mixed with oil. Provide good ventilation, when fueling or handling fuel.

Fuel

- Always use branded 89 octane unleaded gasoline.
- Use genuine two-cycle oil or use a mix between 25:1 to 50:1, please consult the oil bottle for the ratio or HITACHI dealer
- Only for the state of California at 50:1.
- If genuine oil is not available, use an anti-oxidant added quality oil expressly labeled for air-cooled 2-cycle engine use(JASO FC GRADE OIL or ISO EGC GRADE). Do not use BIA or TCW (2-stroke water-cooling type) mixed oil.
- Never use multi-grade oil (10 W/30) or waste oil.
- Always mix fuel and oil in a separate clean container.

Always start by filling half the amount of fuel, which is to be used. Then add the whole amount of oil. Mix (shake) the fuel mixture. Add the remaining amount of fuel.

Mix (shake) the fuel-mix thoroughly before filling the fuel tank.

Fueling

⚠ WARNING!

- Always shut off the engine before refueling.
- Slowly open the fuel tank, when filling up with fuel, so that possible over-pressure disappears.
- Tighten the fuel cap carefully, after fueling.
- Always move the unit at least 3 m (10 ft.) from the fueling area before starting.

Before fueling, clean the tank cap area carefully, to ensure that no dirt falls into the tank. Make sure that the fuel is well mixed by shaking the container, before fueling.

Starting

1. Set ignition switch (1) to ON position. (Fig. 7)
 - *Push priming bulb (4) several times so that fuel flows through the bulb or return pipe. (if so equipped) (Fig. 8)
2. Set choke lever to CLOSED position. (Fig. 8)
3. Pull recoil starter briskly, taking care to keep the handle in your grasp and not allowing it to snap back. (Fig. 9)
4. When you hear the engine want to start, return choke lever to RUN position (open). Then pull recoil starter briskly again. (Fig. 8)

NOTE!

If engine does not start, repeat procedures from 2 to 4.
5. After starting engine, allow the engine about 2-3 minutes to warm up before subjecting it to any load.

Drilling (Fig. 10)

- Always hold unit firmly with both hands on handles and body well balanced.
- Operate at a high engine speed and let drill bit do the work. Do not force bit into hole.
- If material become twisted around drill bit, stop engine, allow unit to cool and remove wire from spark plug before attempting to clear bit.
- Stop engine and inspect unit if abnormal vibration or noise is generated.

How to operate Reverse control (Fig. 11)

- Decrease engine speed to Idle and move shift lever (2) to R (Reverse) position, then accelerate to pull out.
- Shift lever may not move unless engine is running. If so, turn drill chuck a little bit by hand.
- *The purpose of Reverse control is mainly for easy pullout of bit.
- Notel use chuck mount wrench (3) in place of chuck handle and tighten or untighten manually instead of hitting. Do not hit the chuck mount wrench. (Fig. 12, 13)
- To install or loosen the keyless chuck, set a 19mm spanner (1) between gear case and chuck to lock drive shaft. Install the locking bar (2) in the tool bag into the chuck, and then tighten(clockwise) the bar (2) with the enclosed box spanner or loosen (counter-clockwise). (Fig. 14)

Stopping (Fig. 15)

- Decrease engine speed, and push ignition switch to stop position.

Maintenance

MAINTENANCE, REPLACEMENT, OR RE-PAIR OF THE EMISSION CONTROL DEVICES AND SYSTEM MAY BE PERFORMED BY ANY NONROAD ENGINE REPAIR ESTABLISHMENT OR INDIVIDUAL.

Carburetor adjustment (Fig. 16)

⚠ WARNING!

The bit may be spinning during carburetor adjustments.

⚠ WARNING!

Never start the engine without the complete clutch cover and gear case assembled! Otherwise the clutch can come loose and cause personal injuries.

In the carburetor, fuel is mixed with air. When the engine is test run at the factory, the carburetor is adjusted. A further adjustment may be required, according to climate and altitude. The carburetor has one adjustment possibility:

T = Idle speed adjustment screw.

Idle speed adjustment (7)

Check that the air filter is clean. When the idle speed is correct, the bit will not rotate. If adjustment is required, close (clockwise) the T-screw, with the engine running, until the bit starts to rotate. Open (counter-clockwise) the screw until the bit stops. You have reached the correct idle speed when the engine runs smoothly in all positions well below the rpm when the bit starts to rotate. If the bit still rotates after idle speed adjustment, contact HITACHI dealer.

NOTE!

Some models sold areas with strict exhaust emission regulation do not have high and low speed carburetor adjustments. Such adjustments may allow the engine to be operated outside of their emission compliance limits. For these models, the only carburetor adjustment is idle speed.

For models that equipped with low and high speed adjustments, carburetors are pre set at the factory. Minor adjustments may optimize performance based on climate, altitude, etc. Never turn the adjustment screws in increments greater than 90 degrees, as engine damage can result from incorrect adjustment. If you are not familiar with type of adjustment-assistance HITACHI dealer.

⚠ WARNING!

When the engine is idling the bit must under no circumstances rotate.

Air filter (Fig. 17)

The air filter must be cleaned from dust and dirt in order to avoid:

- Carburetor malfunctions.
- Starting problems.
- Engine power reduction.
- Unnecessary wear on the engine parts.
- Abnormal fuel consumption.

Clean the air filter daily or more often if working in exceptionally dusty areas.

Cleaning the air filter

Remove the air filter cover and the filter. Rinse it in warm soap suds. Check that the filter is dry before reassembly. An air filter that has been used for some time cannot be cleaned completely. Therefore, it must regularly be replaced by a new one. A damaged filter must always be replaced.

NOTE!

Saturate the element in 2 cycle oil or the equivalent. Squeeze the element to distribute the oil completely and to remove any excess oil.

Spark plug (Fig. 18)

The spark plug condition is influenced by:

- An incorrect carburetor setting.
- Wrong fuel mixture (too much oil in the gasoline)
- A dirty air filter.
- Hard running conditions (such as cold weather).

These factors cause deposits on the spark plug electrodes, which may result in malfunction and starting difficulties. If the engine is low on power, difficult to start or runs poorly at idling speed, always check the spark plug first. If the spark plug is dirty, clean it and check the electrode gap. Readjust if necessary. The correct gap is 0.6 mm (.024"). The spark plug should be replaced after 100 operation hours or earlier if the electrodes are badly eroded.

NOTE!

In some areas, local law requires using a resistor spark plug to suppress ignition signals. If this machine was originally equipped with resistor spark plug, use same type of spark plug for replacement.

Gear case (Fig. 19, 20)

Apply a good quality lithium based grease through the grease fitting. Lubrication should be applied at 50 hour intervals and more frequent at heavy use.

Fuel filter (Fig. 21)

Remove the fuel filter from the fuel tank and thoroughly wash it in solvent. After that, push the filter into the tank completely.

NOTE!

If the filter is hard due to dust and dirt, replace it.

Cleaning the cylinder fins (Fig. 22)

When wood chips are caught between cylinder fins, the engine may overheat, resulting in lower output. To avoid this, always keep cylinder fins and fan case clean.

Every 100 Operating hours, or once a year (more often if conditions require), clean fins and external surfaces of engine of dust, dirt and oil deposits which can contribute to improper cooling.

Cleaning the muffler (Fig. 23)

Remove the muffler and spark arrestor (if so equipped), and clean out any excess carbon from the exhaust port or muffler inlet every 100 hours of operation.

For long-term storage

Drain all fuel from the fuel tank. Start and let engine run until it stops. Repair any damage which has resulted from use. Clean the unit with a clean rag, or the use of high pressure air hose. Put a few drops of two-cycle engine oil into the cylinder through the spark plug hole, and spin the engine over several times to distribute oil. Cover the unit and store it in a dry area.

Maintenance schedule

Below you will find some general maintenance instructions. For further information please contact HITACHI dealer.

Daily maintenance

- Clean the exterior of the unit.
- Check that the drilling attachment is properly centred, sharp, and without cracks. An offcentred bit induces heavy vibrations that may damage the unit.
- Check that the drilling attachment is sufficiently tightened.
- Check that nuts and screws are sufficiently tightened.

Weekly maintenance

- Check the starter, especially cord and return spring.
- Clean the exterior of the spark plug.
- Remove it and check the electrode gap. Adjust it to 0.6 mm, or change the spark plug.
- Clean the cooling fins on the cylinder and check that the air intake at the starter is not clogged.
- Check that the angle gear is filled with grease up to 3/4.
- Clean the air filter.

Monthly maintenance

- Rinse the fuel tank with gasoline.
- Clean the exterior of the carburetor and the space around it.
- Clean the fan and the space around it.