

Paslode  
**IMPULSE**<sup>®</sup>  
CORDLESS POWER FASTENING SYSTEM

---

**IM325 SOLID STATE  
CORDLESS NAILER**

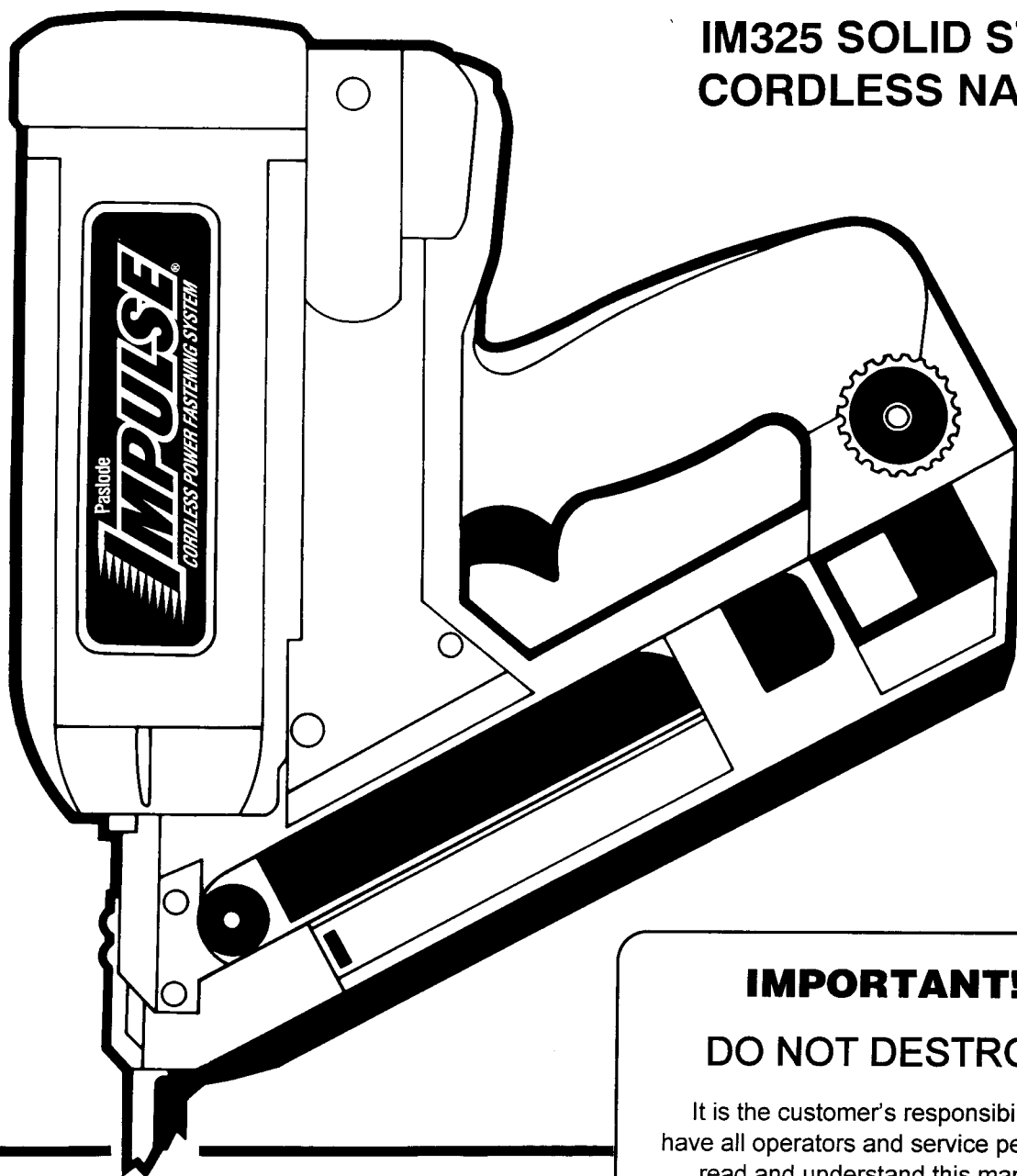

**IMPORTANT!**

**DO NOT DESTROY**

It is the customer's responsibility to have all operators and service personnel read and understand this manual.

---

**OPERATING MANUAL**

# Fuel Cell and Metering Valve

## Inserting Fuel Cell

Inserting the metering valve/fuel cell assembly into the Impulse Nailer is very simple. To begin, press up at the bottom of the actuator cover and pivot outward to open. The cover will swing out of the way.

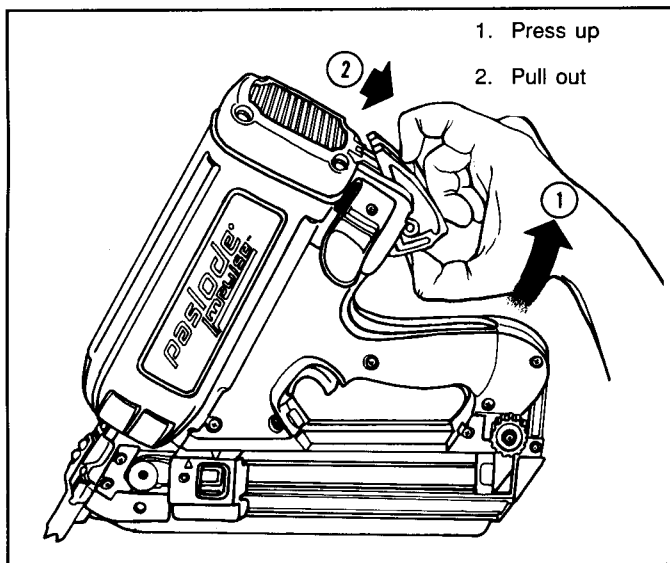

Next, with the metering valve stem pointed toward the front of the tool, insert the metering valve/fuel cell assembly.

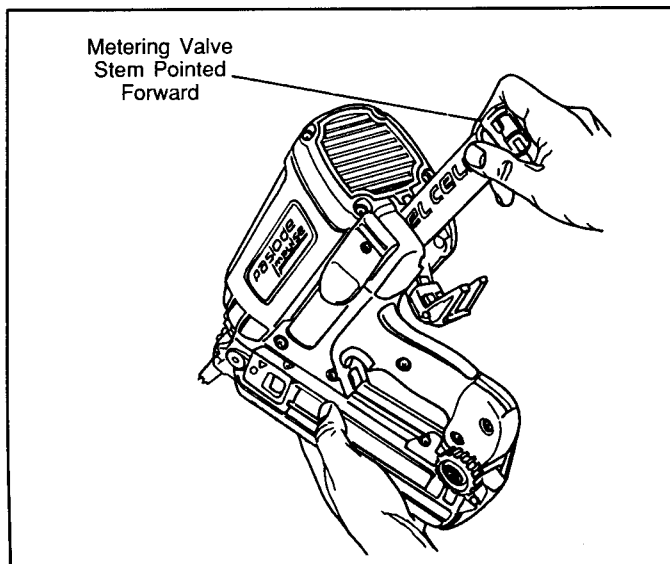

As you slide the metering valve/fuel cell assembly into the Impulse Nailer, you will notice a red adapter at the top of the cylinder pocket. As shown in the illustration, this adapter is designed to ensure that the metering valve stem is properly aligned with the small hole, or orifice, that leads to the combustion chamber. Insert the metering valve stem into the orifice of the red-colored adapter.

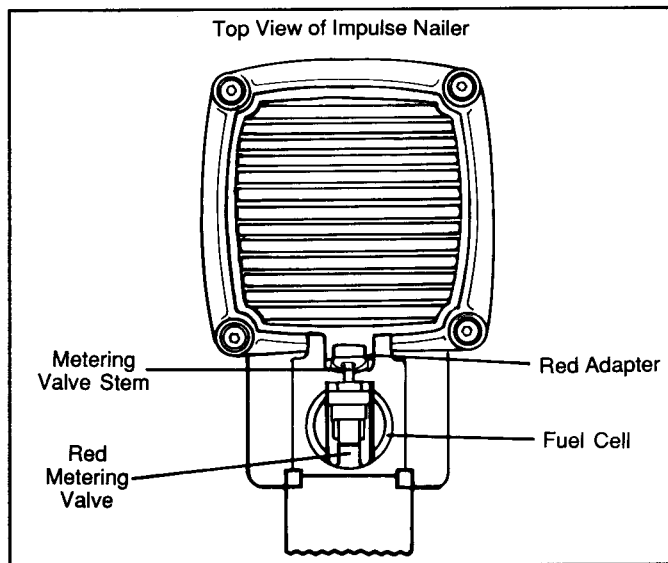

Close the actuator cover to complete the loading of fuel in the Impulse Nailer. Do this by swinging it up and over the fuel valve/cylinder assembly, and pushing down until the actuator cover snaps into position.

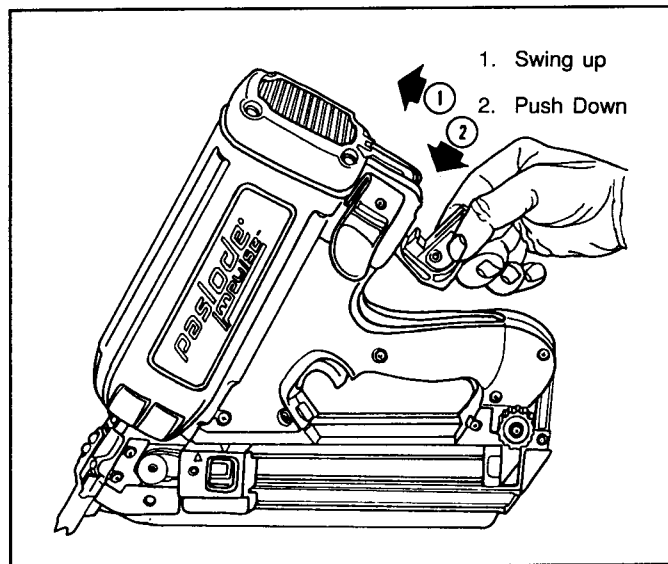

# Preparing the Impulse Nailer for Use

## Fasteners

The Impulse Nailer drives Paslode clipped-head nails, which have been collated into strips. The use of nails that do not meet Paslode standards could cause tool damage and void your warranty. Paslode nail sizes and types are illustrated in the Fasteners and Applications section.

## Loading Fasteners

The illustration below shows how to load fasteners into the Impulse Nailer properly. To load, simply insert a strip of Paslode nails into the rear of the magazine and slide forward. Next, while applying pressure to the release lever, pull the follower toward the rear of the magazine until the follower locks securely behind the strip of fasteners. Release the follower, and let the follower push the nail strip forward into the nose of the tool.

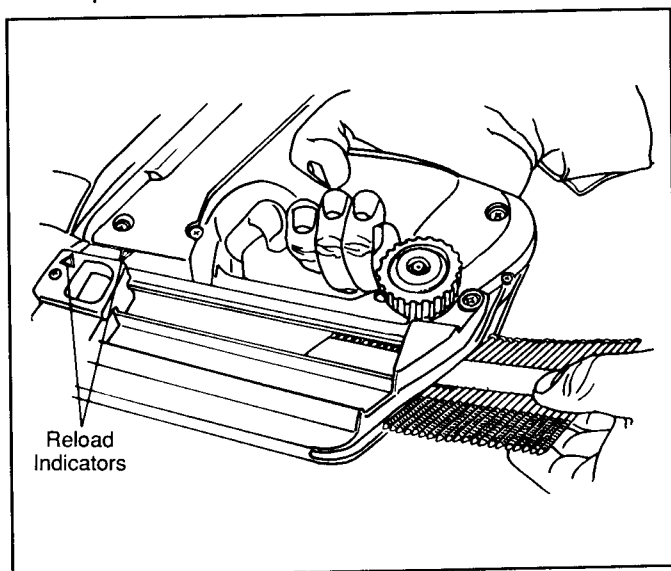

In the illustration above, you will see that there is an indicator arrow on the side of the follower. When the indicator arrow is in the reload area, marked on the side of the magazine, you may insert a new strip of nails. You will be able to drive about five more nails when the follower first reaches the reload area before the Impulse tool automatically locks the trigger to prevent the tool from operating. To unlock the tool, simply insert another strip of fasteners. The purpose of this feature is to prevent needless blank cycling, which could damage tool components and waste fuel.



## DANGER

Five (5) nails will also be left in the magazine after a strip has been used. The indicator arrow shows that you can reload. This does not indicate that the Impulse Nailer is empty. Because of a lockout feature in the Impulse Nailer tool, it will not operate when the nail supply in the tool is less than six (6) fasteners.

## Outdoor Weather and Impulse Nailer

Use the Impulse Nailer outdoors, in clear weather, when the nailer, fuel cell, and battery are between 20°F (-7°C) and 120°F (49°C).

### HOT WEATHER OPERATION

The Impulse tool requires cooling of the motor assembly to operate properly. The fan normally provides the necessary air flow to permit continuous operation. Whenever the Impulse is idle for extended periods, keep the fuel and tool out of direct sunlight and in surroundings where temperatures will not exceed 120°F (49°C). After extended periods of continuous use, it may be necessary to cool the Impulse motor by running the fan for 2-3 minutes or until the tool operates normally. An overheated tool may not drive nails completely or may operate erratically.

### COLD WEATHER OPERATION

Fuel cells at cold temperatures lose the required propellant force. Bring the tool, battery cell, and fuel cell above minimum operating temperature without direct exposure to flame, and check the battery.



## CAUTION

The Impulse Nailer should not be used in the rain or where excessive moisture is present. The use of the Impulse Nailer under these conditions may result in damage to tool components and cause tool to malfunction.

# Impulse Nailer Operation

## IMPORTANT NOTE FOR SOLID STATE

For all drive cycles the trigger must not be squeezed prior to activation of work contact element. Follow tool operation steps below.

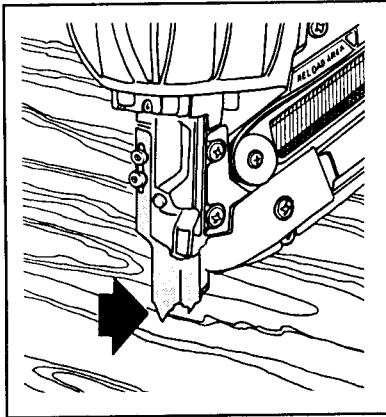

**PRESS WORK – CONTACT ELEMENT AGAINST THE WORK SURFACE.** Fan motor will turn on (allow fan motor to reach full operation speed, 1-2 seconds.) LED will be steady green. Fuel is injected into combustion chamber and mixed with air by the fan.

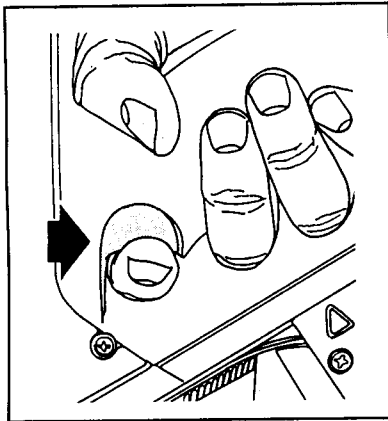

**SQUEEZE THE TRIGGER.** The spark plug sparks and fuel/air mixture ignites. Combustion powers the piston assembly driving fastener.

**LIFT THE TOOL - RELEASE THE TRIGGER.** The combustion chamber opens. Fan exhausts hot gases and cools internal components.

**NOTE:** If no additional cycles are made fan will run for 10 seconds and then shut off.

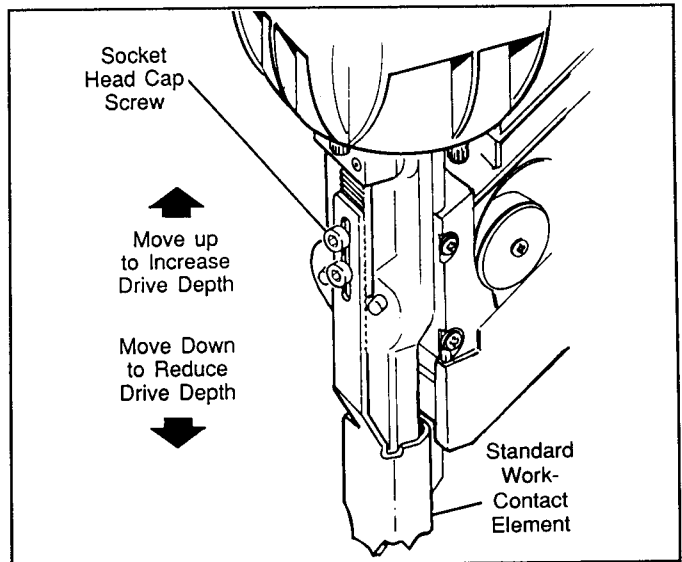

## Depth of Drive Adjustment

Remove the fuel cell before adjusting the depth of drive.

The depth of drive adjustment is made by adjusting the work-contact element. The two (2) socket head cap screws indicated in the illustration are loosened to allow the work contact element to be moved up or down. You will need to use the allen key provided with the tool to make this adjustment.

If the tool is overdriving (the nail head is driven below the surface of the wood), the work-contact element should be moved down slightly. If the nails stand up (the head is not flush with the work surface), the work-contact element should be moved up slightly.

## WARNING

The work-contact element and nose will become hot after prolonged or rapid use. If it becomes necessary to adjust the work-contact element, avoid touching with bare hands.

## No-Mar Work-Contact Element

For applications where the workpiece must be mark free, such as siding and recreational decks, order the Impulse No-Mar Work-Contact Element, Part No. 402502.

## WARNING

Never attempt to operate the Impulse tool unless both adjustment screws are installed. Intentional removal of an adjustment screw could result in improper tool operation, loss of nail control and injury to tool user or bystanders.

# Fasteners and Applications

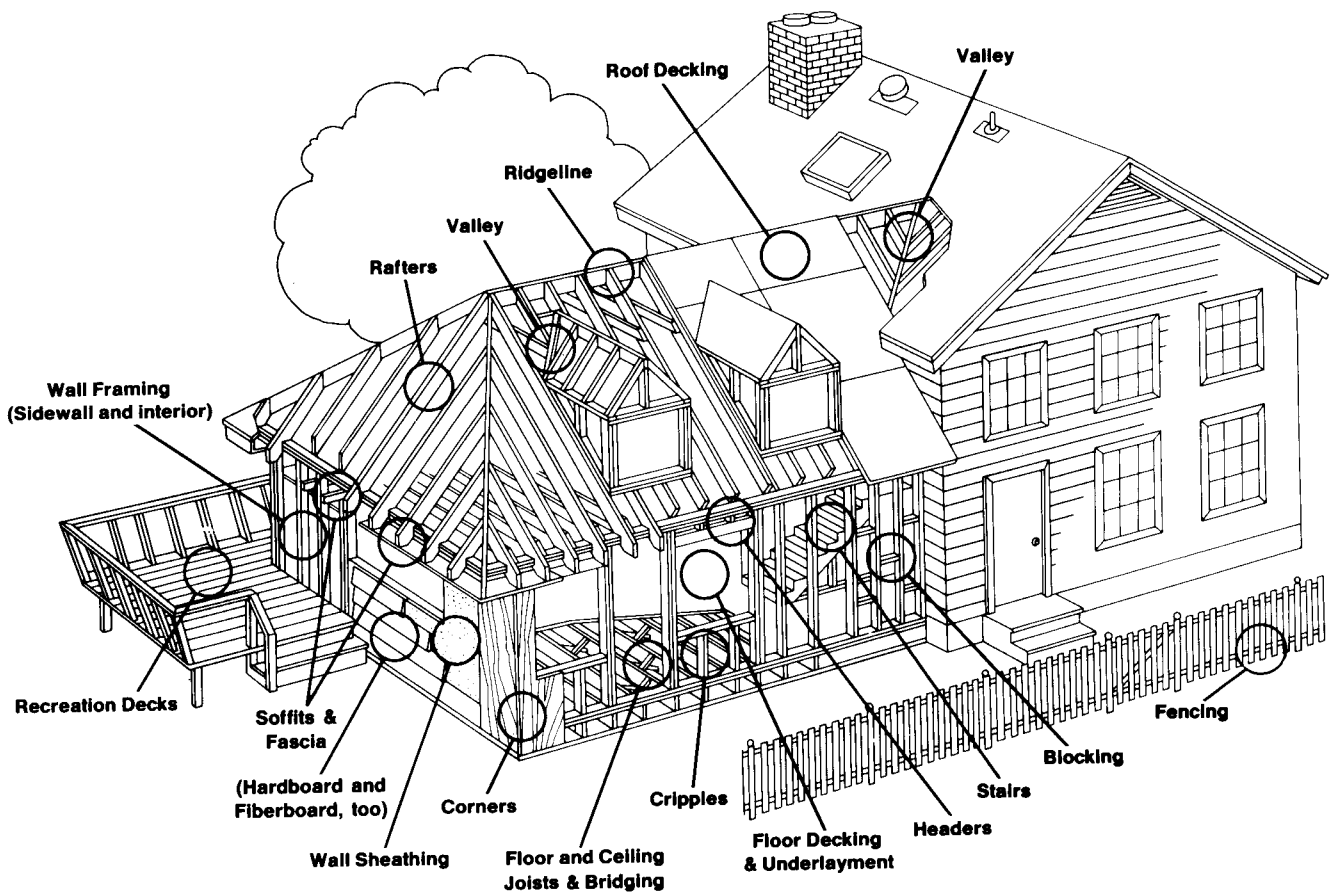

SIZE	TYPE	APPLICATION
2" x .113 (6D)	Common ring shank	Underlayment, wall sheathing, roof and floor decking, siding
2" x .113 (6D)	Common ring shank, mechanically galvanized	Fencing, siding
2-3/8" x .113 (8D)	Cooler ring shank	Roof and floor decking, underlayment, sheathing
2-3/4" x .113 (9D)	Coated ring shank, mechanically galvanized	Recreational decking, siding, fencing
3" x .120 (10D)	Coated nail	Remodeling
3" x .120 (10D)	Ring shank, mechanically galvanized	Fencing, recreational decking, siding, tile roofs
3" x .131 (10D)	Coated nail	Framing
3-1/4" x .131 (12D)	Coated nail	Framing

# Fasteners and Applications

The Impulse Nailer drives Paslode clipped-head nails, which have been collated into strips. The use of nails that do not meet Paslode standards could cause tool damage and void your warranty. Paslode offers a variety of sizes and styles for many applications.

**Smooth Shank** - For general construction, carpentry and framing: the most popular and versatile.







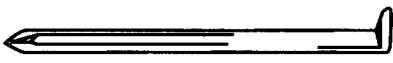

**Ring Shank** - The ring shank provides improved withdrawal resistance for applications where the resistance from smooth shank fasteners is not adequate: floor decking, grating, pallets.

**Ring Shank-Blunt Point** - For applications where wood splitting must be minimized.

**Hardened Steel**- For attaching wooden plates to green concrete foundations; 2X furring strips to cinder block.

**Electro-Galvanized** - These nails may be used where a corrosion resistant fastener is required and no minimum coating thickness is specified for the fastener.

**Mechanically Galvanized** - These nails should be used where higher corrosion resistance is required to retard rust and rust staining, and may be used whenever a standard hot dipped nail is specified. Recommended for use in natural wood siding, such as cedar, redwood, cypress and preservative treated lumber. (Not for use in all-weather wood foundations.)

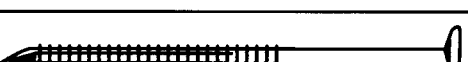
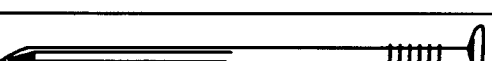
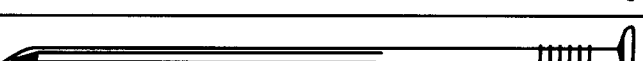
THE IMPULSE NAILER DRIVES THESE NAILS	PART NO.	SIZE	TYPE
	097385	2" x .113	Smooth Shank
	097386	2" x .113	Smooth Shank, Electro-Galvanized
	097387	2" x .113	Ring Shank
	097388	2" x .113	Ring Shank Electro-Galvanized
	403389	2" x .113	Ring Shank, Mechanically Galvanized
	401548	2-1/4" x .113	Smooth Shank, Hardened Steel
	097394	2-3/8" x .113	Smooth Shank
	097395	2-3/8" x .113	Smooth Shank, Electro-Galvanized
	097724	2-3/8" x .113	Smooth Shank, Mechanically Galvanized
	097397	2-3/8" x .113	Ring Shank
	405113	2-1/2" x .131*	Fullhead, Ring Plex
	405114	3-1/4" x .131*	Fullhead, Ring Plex

\* For use with IM325 Ring Plex Tool

Manual # 614

Plant No. 0671 004 e 005

Nail Gun Impulse Framing.

SCANNED

Paslode

# IMPULSE

**CORDLESS POWER FASTENING SYSTEM**

09/2010

## IM325 SOLID STATE CORDLESS NAILER

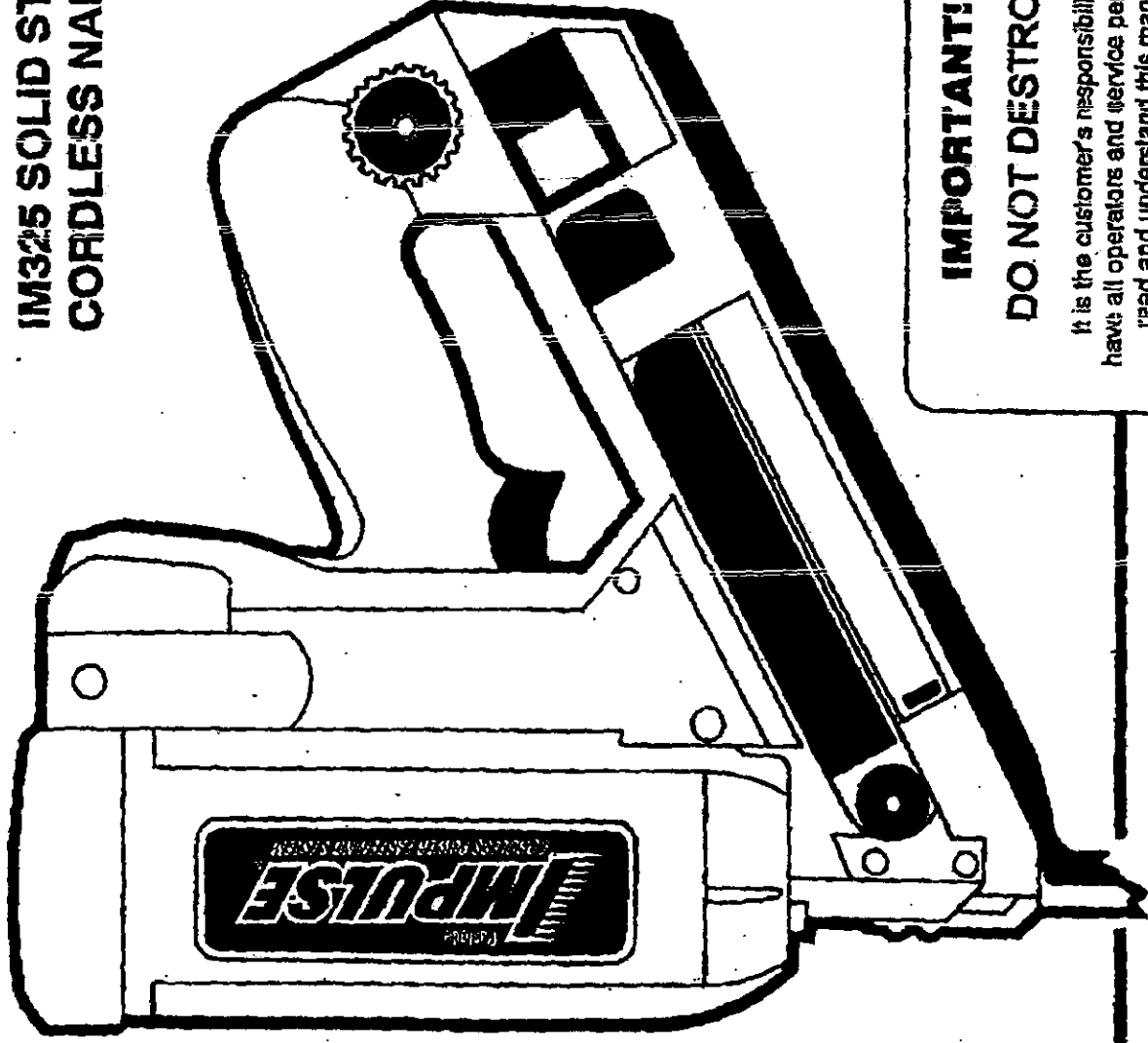

**IMPORTANT!**

**DO NOT DESTROY**

It is the customer's responsibility to  
have all operators and service personnel  
read and understand this manual.

## OPERATING MANUAL

Printed in USA

402829  
12

### OPERATING MANUAL FOR IMPULSE CT CORDLESS NAILER

Addition to the General Safety Manual for Internal Combustion Fastener Driving Tools

#### 1. Before using the Tool

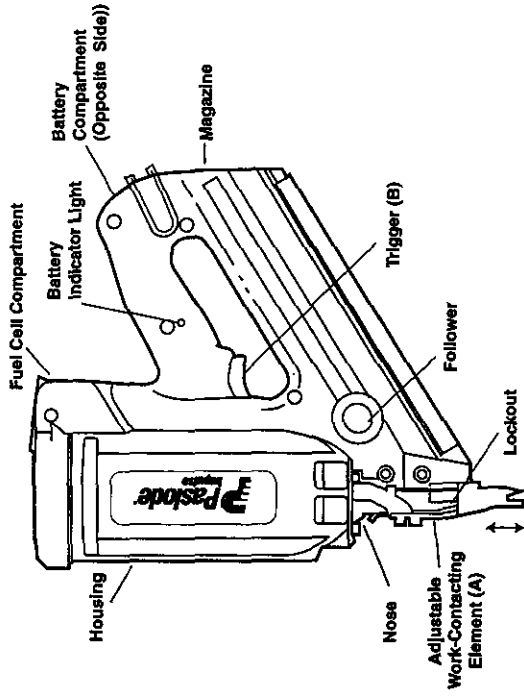

Read safety and operating manuals. Only use the tool when all instructions are understood. Check work contact element/safety yoke (A) for smooth operation.

Use only for timber to timber fixings or material of similar or lesser density.

Attention: This tool must not be used in a combustible environment.

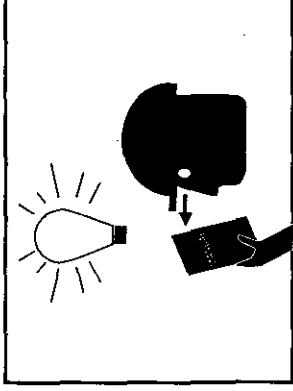

#### 2. Battery Loading

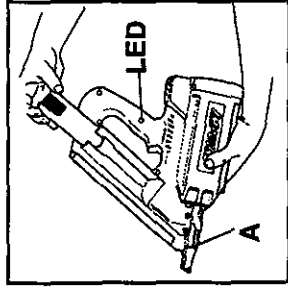

Load Impulse battery cell with contacts facing downwards into the battery compartment. Press firmly until battery locking clip is engaged. To remove battery press the locking clip on the battery and slide battery out of its compartment.

LED in Handle of Tool:

LED strobe light green

LED strobe light red

When work contact element (A) is depressed against workpiece:

LED solid green

LED solid red

To recharge battery read charging instructions.

Battery contacts must be clean and free from corrosion; if necessary clean with fine emery cloth.

> Battery in tool. (Does not indicate state of charge)

> Battery is empty, recharge battery!

> Battery charge ready for use.

> Battery empty. Recharge!

#### 3. Loading Fuel Cell

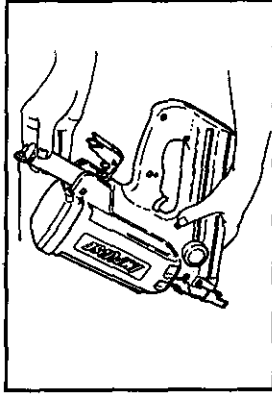

Prior to loading fuel cell ensure that the cell protective cap has been removed as detailed in the safety manual. For the Impulse CT nailer use fuel cells with the red ring on metering valve.

To load fuel:-

1. Open the cover of the fuel cell compartment by pressing inwards and lifting.

2. Insert fuel cell into fuel compartment and locate the stem of the metering valve into the orifice in the red adaptor.

3. Close the cover of the fuel compartment, taking care not to disturb the alignment of the fuel cell.

#### 4. Fastener Loading, Reloading and Removal

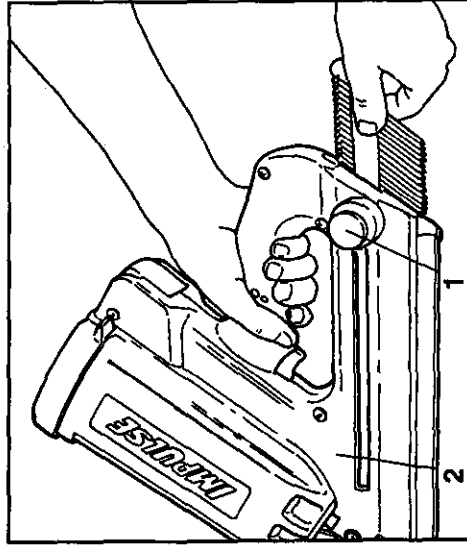

To load Fasteners:

1. Pull back the follower (1) until it reaches the locked position at the end of the magazine.

2. Insert Paslode fasteners selected from technical specification sheet into the slot at the rear of the magazine.

The fasteners will slide freely into the tool.

3. Release the follower lock by depressing centre button on the follower and gently allow the follower to push the fastener strip forward to the correct firing position. Do not allow the follower to spring forward against the fastener strip otherwise collation may be damaged.

4. Reload tool when centre button has reached "reload" arrow (2) or lock-out mechanism is activated.

5. To unload fasteners again pull back follower to the locked position and simply slide out fasteners.

Note: 1) Do not depress trigger when loading or unloading fasteners.

2) The lockout mechanism is activated when approx. 5 nails remain in magazine. To remove these refer to point 5 above.

With fasteners, Battery and Fuel Cells loaded the Tool is now ready for use.

### 5. Trigger System

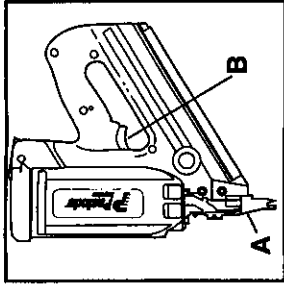

The Impulse CT nailer is equipped with a full sequential actuation (trigger) system for safety. For each operation the work contacting element (A) and trigger (B) must be actuated. For operation press work contacting element (A) on workpiece and squeeze trigger (B) for release of nail. Thereafter any further driving operations can only be actuated if the trigger (B) and work contacting element (A) have been returned to the starting position.

### 6. Cycle Rate

Intermittent Operation - 2 to 3 nails per second

Continuous Operation - 1000 nails per hour

**NOTE:** Exceeding these rates could cause tool to overheat, resulting in loss of performance or damage to tool components. By using the Impulse Compact™ nailer at its recommended cycle rate, you will be able to drive several thousand nails in a typical workday.

### 7. Tool Operation

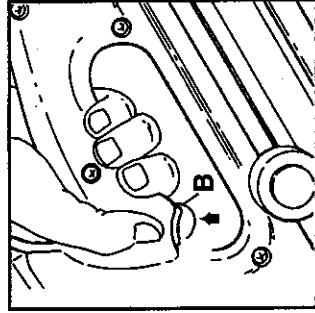
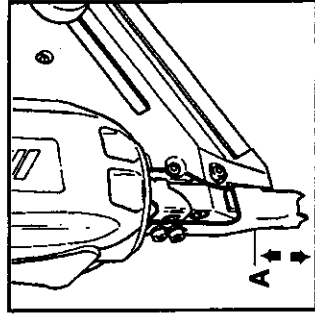

1. Taking a firm grip of the tool handle fully depress the work contact element/safety yoke (A) against the work surface. This will close the combustion chamber, inject fuel and the fan will mix air and fuel.
2. Squeeze the trigger (B). The injected fuel in the combustion chamber is ignited and the combustion drives the piston assembly which in turn drives the fastener.
3. Release trigger and lift tool. Combustion chamber opens, fan cools tool internals. N.B. Fan will run for approximately 10 seconds after nailing is completed.
4. Tool is ready for the next cycle. **NOTE:** the tool is equipped with a lock-out mechanism operating when only 4-5 nails are left in magazine.

### 8. Depth of Drive Adjustment

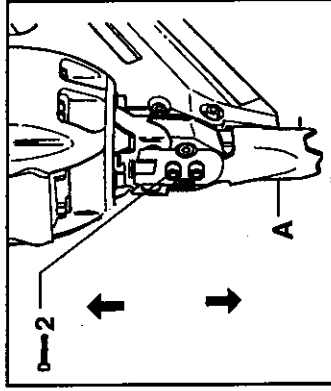

The driven depth of a fastener may be adjusted by lengthening or shortening the overall length of the work contact element/safety yoke (A). To adjust work contact element/safety yoke (A):

1. Remove fuel and battery cells.
2. With Hex key provided, slacken 2 screws on the work contact element/safety yoke (A) and move the bracket in the direction required to achieve desired depth.  
Moving bracket upwards increases penetration and moving bracket downwards reduces penetration.
3. Retighten screws, refit fuel and battery cell.

### 9. Clearing a Nail Jam

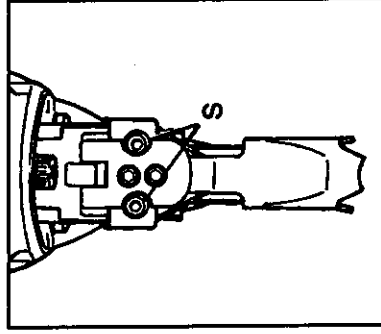
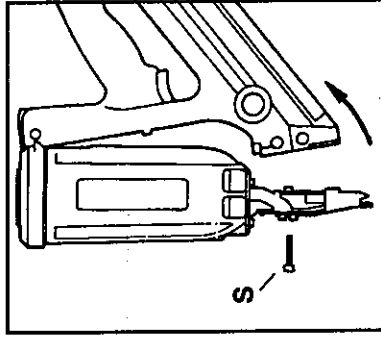

Should a fastener jam in the nose of the tool proceed as follows:

1. Remove fuel and battery cells.
2. Pull follower back to locked position and remove fasteners.
3. Undo and remove the two magazine mounting screws (S).
4. Ease the magazine away and remove jammed fastener.
5. Re-align magazine and refit mounting screws (S).
6. Reload fuel and battery cells.
7. Reload fasteners and release follower.

# Fasteners and Applications

The Impulse Nailer drives Paslode clipped-head nails, which have been collated into strips. The use of nails that do not meet Paslode standards could cause tool damage and void your warranty. Paslode offers a variety of sizes and styles for many applications.

**Smooth Shank** - For general construction, carpentry and framing: the most popular and versatile.













**Ring Shank** - The ring shank provides improved withdrawal resistance for applications where the resistance from smooth shank fasteners is not adequate: floor decking, grating, pallets.

**Ring Shank-Blunt Point** - For applications where wood splitting must be minimized.

**Hardened Steel** - For attaching wooden plates to green concrete foundations; 2X furring strips to cinder block.















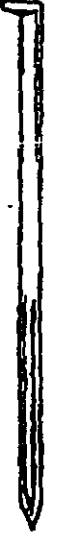



**Electro-Galvanized** - These nails may be used where a corrosion resistant fastener is required and no minimum coating thickness is specified for the fastener.

**Mechanically Galvanized** - These nails should be used where higher corrosion resistance is required to retard rust and rust staining, and may be used whenever a standard hot dipped nail is specified. Recommended for use in natural wood siding, such as cedar, redwood, cypress and preservative treated lumber. (Not for use in all-weather wood foundations.)

THE IMPULSE NAILER DRIVES THESE NAILS	PART NO.	SIZE	TYPE
	097385	2" x .113	Smooth Shank
	097386	2" x .113	Smooth Shank, Electro-Galvanized
	097387	2" x .113	Ring Shank
	097388	2" x .113	Ring Shank Electro-Galvanized
	403389	2" x .113	Ring Shank, Mechanically Galvanized
	401548	2-1/4" x .113	Smooth Shank, Hardened Steel
	097394	2-3/8" x .113	Smooth Shank
	097395	2-3/8" x .113	Smooth Shank, Electro-Galvanized
	097724	2-3/8" x .113	Smooth Shank, Mechanically Galvanized
	097397	2-3/8" x .113	Ring Shank
	405113	2-1/2" x .131"	Fullhead, Ring Shank
	405114	3-1/4" x .131"	Fullhead, Ring Shank

\* For use with IM325 Ring Plex Tool

# Fasteners and Applications

THE IMPULSE NAILER DRIVES THESE NAILS	PART NO.	SIZE	TYPE
	097384	2-3/8" x .113	Smooth Shank
	097387	2-3/8" x .113	Ring Shank
	097388	2-3/8" x .113	Ring Shank, Electro-Galvanized
	403389	2-3/4" x .113	Ring Shank, Coated* Mechanically Galvanized
	097989	2-3/4" x .120	Smooth Shank, Coated*
	097970	2-3/4" x .120	Ring Shank, Coated*
	097971	3" x .120	Smooth Shank, Coated*
	097972	3" x .120	Smooth Shank, Coated* Mechanically Galvanized
	097973	3" x .120**	Ring Shank, Coated*
	403981	3" x .120**	Ring Shank, Coated* Mechanically Galvanized
	409470	3" x .120**	Ring Shank, Coated* Electro-Galvanized
	404050	3-1/4" x .120*	Smooth Shank, Coated*
	401696	3" x .131	Smooth Shank, Coated*
	097975	3-1/4" x .131	Smooth Shank Coated*
	097986	3-1/4" x .131	Smooth Shank, Coated* Mechanically Galvanized
	403469	3-1/4" x .131	Smooth Shank, Coated* Electro-Galvanized
	097978	3-1/4" x .131**	Ring Shank, Coated
	409878	3-1/4" x .131**	Ring Shank, Galvanized TL

All nails pictured actual size.

\*Coated with an acrylic resin for ease of drive and greater holding strength.  
\*\*Ring Shank nails in treated lumber or hardwood.



# GENERAL SAFETY MANUAL FOR INTERNAL COMBUSTION FASTENER DRIVING TOOLS

Page	Page
1 ... 4	17 ..... 20
5 ... 8	21 ..... 24
9 ... 12	25 ..... 28
13 .. 16	29 ..... 32

**DK**

**GB**

**S**

**D**

**N**

**F**

**SF**

**NL**

Congratulations on having chosen a Paslode product. Your tool will operate to your full satisfaction for a long time if handled correctly according to the General Safety Manual and Tool Operating Manual. Use Paslode specified fasteners, fuel cell, rechargeable battery and spare parts only.

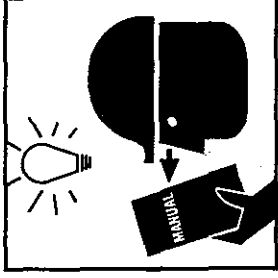
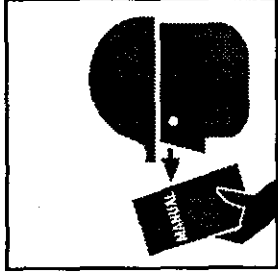
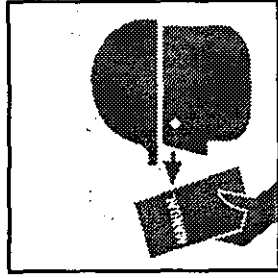
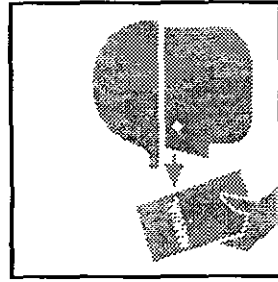

Read all safety and operating instructions about tool, fuel cell, battery and battery charger and observe them carefully.

## Safety Instructions

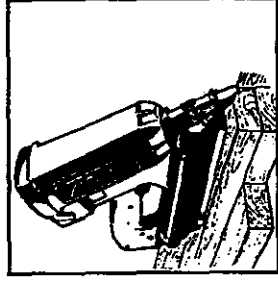

**IMPULSE SYSTEM**  
The IMPULSE SYSTEM consists of tool, fasteners, fuel cell, battery and battery charger. Only Paslode-specified fasteners fuel cell, battery and battery charger may be used. Reference the spec. sheet of the tool. The specified units must be seen as a single system in terms of technical safety.

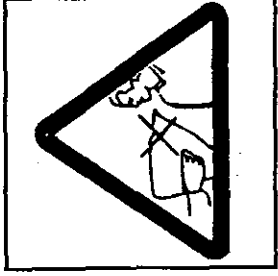

**FASTENER TOOLS**  
Never carry tool with trigger depressed. Do not point the work contacting element (safety yoke) at your own body or at somebody else. After having work completed, take fuel cell and battery out of tool. Keep tool and parts away from children and unauthorized persons. Store tool, battery and fuel cell in tool case when not using it for some time.

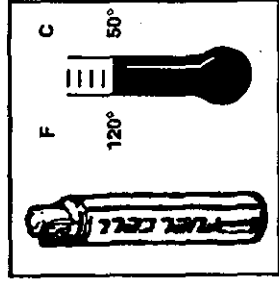

**IMPULSE FUEL CELL**  
The fuel cell is an aerosol product, the contents are flammable. The container is under pressure. Protect from exposure to temperatures above 50°C (120°F) (i.e. sunlight)! Do not spray against open flame or hot surfaces. Use outside or in well-ventilated areas. Do not burn, attempt to open, or puncture after use. Dispose of according to local regulations for aerosol products.

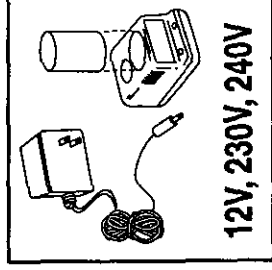

**IMPULSE BATTERY-BATTERY CHARGER**  
Use only Paslode IMPULSE 6V battery and IMPULSE battery charger. Check for correct electric voltage. Observe data on battery charger. Store indoors at temperatures below 50°C. Do not recharge at temperatures below 5°C or above 40°C. Do not open battery and do not throw into fire. Do not dispose of with garbage. Observe local regulations for disposal.

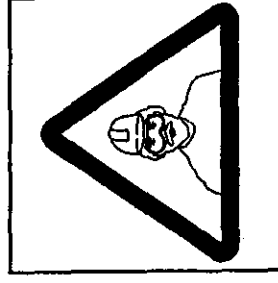

**EYE PROTECTION**  
When operating the tool always wear approved eye protection. Small fragments might be shot from work piece. Eye protection is also recommended for persons close to work place.

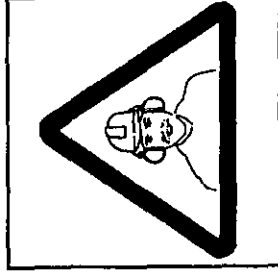

**HEARING PROTECTION**  
Wear hearing protection when operating the tool. This reduces the sound level at your ear considerably. Hearing protection is also recommended for persons close to the work place.

# IMPULSE SYSTEM

## Impulse Tool

GB

### The tool consists of three main assemblies:

#### Housing with:

Combustion Chamber,  
Nosepiece, Safety Yoke,  
Piston and Driver.

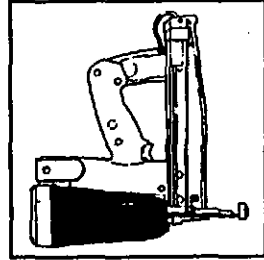

#### Handle with:

Tool Electronic, Motor,  
Spark plug, Trigger and  
Compartment for fuel cell.

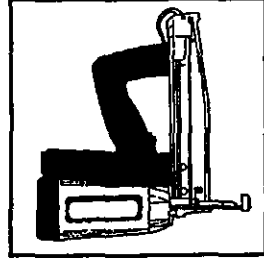

#### Magazine for:

Consumables with  
follower and compartment  
for Battery.

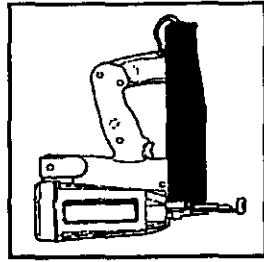

#### Fuel Cell:

Consisting of container for  
fuel (1) and propellant  
metering valve (2) and  
protective cap (3).

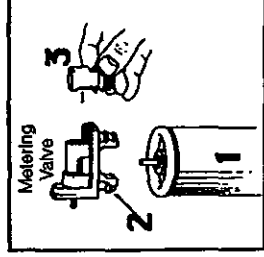

#### Battery/Battery

##### Charger

The battery supplies  
power to the tool  
electronic, fan, and spark  
plug.

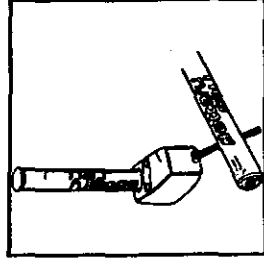

### Impulse-Tool: Operation

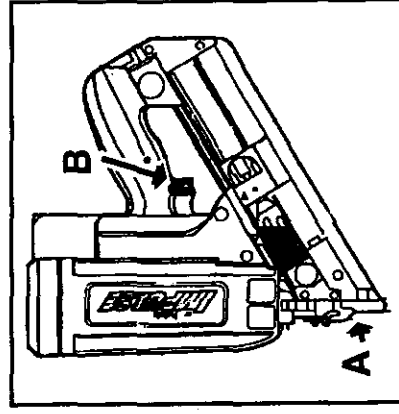

Impulse tool works according to the principles of a linear internal combustion engine.

Press work contacting element of the tool (A) against work piece.  
Combustion chamber is closing and fuel injected.  
Fan mixes air and fuel.

Fuel/air mixture ignites by pulling trigger (B).  
Combustion drives piston with driver.  
Piston and driver return to initial position.

Lift tool from work piece.  
Combustion chamber opens and releases exhaust fumes.  
Fan cools tool.  
Impulse tool is ready for next single cycle.

### Impulse-Fuel Cell: Technology/Service/Safety

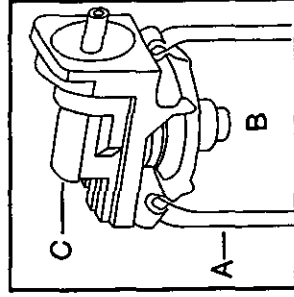

The fuel cell is an Aerosol product according to  
regulation 75/324 EEC and TRG 300 (D). The  
propellant (A) keeps the fuel (B) in the inner  
container permanently pressurized. The  
metering valve (C) regulates the correct fuel  
dosage for each cycle.

Contents of Fuel Cell:  
-Hydrocarbon liquid, i.e. propane, butane.  
-Lubrication for piston.

*Typical smell of mercaptane.*

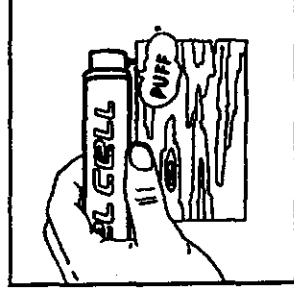

Press metering valve stem on fuel  
cell three times against a stationary  
object and release. If gas is not  
dispersed, fuel cell is empty-replace  
it. Use the right fuel cell to ensure  
the correct dosage of fuel. Look for  
the correct colour of the dosage  
valve ring (see tool operating  
manual).

Observe Safety Regulations.

**Safety Regulations:** The propellant will remain in the fuel cell. Fuel cell is always under pressure. Propellant and fuel are flammable. Expanding gases cause low temperatures. Caution, fluid gases might cause injuries when getting in touch with skin or eyes. The fuel cell is to be used as stated in the "Fuel Cell" section. Refill forbidden!

### Impulse - Fuel Cell: Symbols and their Meanings



Contains no  
chlorofluorocarbon.

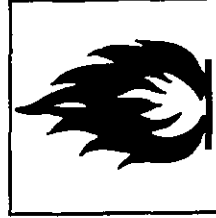

Danger!  
Flammable liquid  
agents and gases.

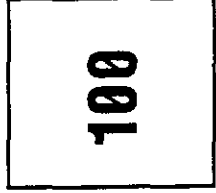

Net capacity (ml)  
of fuel cell.

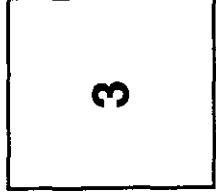

Reverse Epsilon.  
Aerosol Product  
according to  
regulation  
75/324/EEC.



Weight of contents  
according to  
official standards.

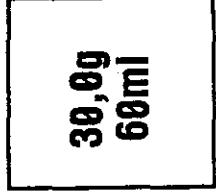

Fuel weight/  
volume in inner  
container.

# IMPULSE-Fuel Cell: Preparation for Use

GB

The fuel cell is equipped with a safety device for transportation and cannot be placed into tool as delivered. Get it ready for use by observing the following steps:

**NOTE:** Do not smoke when, handling the fuel cell, do not inhale its contents.

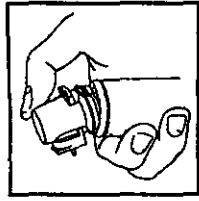

Lift protective cap and dosage valve from fuel cell.

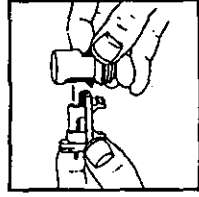

Separate metering valve from protective cap.

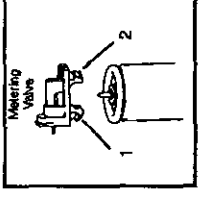

Metering valve has a front 1 and back 2 ridge to fit on fuel cell.

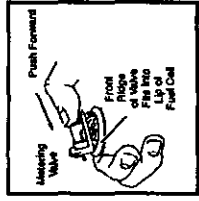

Place front ridge of metering valve into lip of fuel cell.  
**WARNING**  
Keep valve stem away from face and eyes.

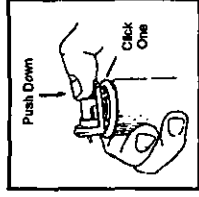

Press back ridge of valve firmly over lip of fuel cell.  
**FIRST CLICK!**

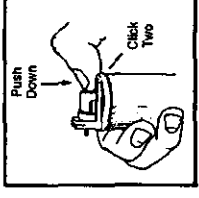

Press valve further down firmly until it snaps into place.  
**SECOND CLICK!**  
Valve fits.

## IMPULSE-Fuel Cell: Transportation/Storage

### Transportation

According to GGVS-ADR no special licence is demanded for transportation of fuel cells.

- Road/Railway: see GGVS-ADR/RID Cl.2/ITEM 10B2
- Seafreight/Boat: see IMDG Cl.9/P.9022/EmS No. 2-13
- Air/IATA-DGR: see Cl.2/Risk Gr.3/PackInstr. 203/ max. weight per shipment 75 kg/ cargo 150 kg.

### NOTE:

- Goods must be accompanied by transport emergency card for road UN No. 1950.
- (Emergency Cl.2 GGVS/ADR, Rn. No. 2201, Item 10B2)
- Transportation of small quantities for own use in private car is allowed without shipping papers and emergency card.
- Observe temperature limit of 50°C

### Safety Rules:

- Shipment of fuel cells per mail is not allowed.

### Storage:

All local instructions according to fire brigade regulations have to be observed. Store- and sales rooms must be in line with the rules of the Building Supervisory Authorities.

- Do not store above 50°C; do not store in passages, entry halls or near doors.
- Always keep room well ventilated.
- In store rooms fuel cells must not take more than 20 square meters of room surface.
- Do not store together with pyrotechnical goods.
- The quantity stored in sales rooms should not exceed daily sales.
- Sales booths should not be close to exits. A fire extinguisher of 6kg, class A, B, C must be available.
- Tools with an open flame or high temperature must not be operated near fuel cells.
- Fuel cells must not be displayed in shop windows.

## General Notes: IMPULSE -Operation and Service

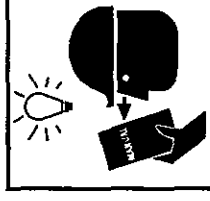

Understand operating manual and safety instructions before operation.

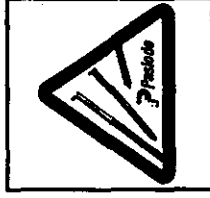

Only use specified Paslode fasteners and spare parts.

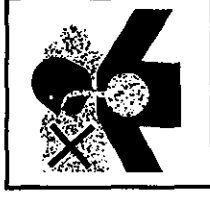

Only work outside or in well ventilated area.

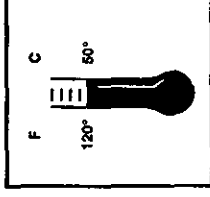

Never heat fuel cell and tool loaded with fuel cell above 50°C.

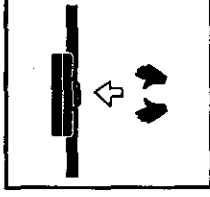

Put tool into tool case for storing and transportation.  
Keep out of reach of children.

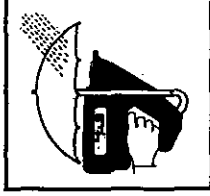

Do not use tool in the rain or where excessive moisture is present.

The following servicing can be performed by yourself: ( also see tool operating manual)

- Clean tool with soft cloth or brush, lubricate trigger and safety yoke if necessary slightly with Impulse oil.
  - Check safety nose for smooth running.
  - Adjust driving-in depth.
  - Check and reload battery.
  - Check fuel cell for functioning.
  - Clean air filter.
- Beware!**  
Before performing any servicing take fuel cell, battery and fasteners out of tool.
- Clean points of contact of battery.
  - Check wire.
  - Clear a fastener jam.

If you can not service the tool properly, send it to your Paslode service station for a check up. Never work with a tool that is not operating properly. Repair works are to be carried out by Paslode Service personnel or its representatives who must be instructed sufficiently about Impulse technology to be able to judge a safe working condition of the tool.

# Safety Instructions/Information

GB

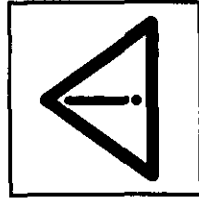

Observe all safety instructions! To avoid injuries to yourself or another person observe also the specific operating manual and service instructions for your tool.

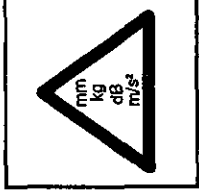

For technical datas, sound—and vibration values, information about fuel cell, battery and recharger, specified consummables please see your operating manual and ITW Paslode technical data sheet.



Only use fasteners, battery, fuel cell, battery charger and spare parts as specified in the tool data sheet. Paslode shall in no event be liable by nonobservation of the instructions. Fasteners are to be used only with timber-to-timber fixing or materials of similar or lesser density if not otherwise specified.



Do not operate close to flammable materials. Exhaust fumes may get heated up depending on work speed. Observe datas about speed of work in tool data sheet.



This tool must be operated only in a well ventilated environment. Operation of tool causes exhaust fumes of carbon monoxide which are a danger to health when inhaled.

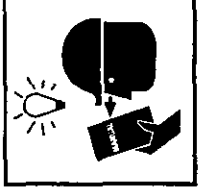

Observe local regulations about storage, handling and transportation of aerosol products (12 bar/50°C). Storage according to TRG300 (D). International transport regulations are established according to ADR/RID, IATA-DGR, IMDG-Code. No mailing!

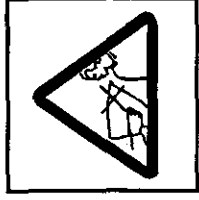

This tool is not a toy. Never assume the tool is empty. Never point the tool at anyone or yourself. Never carry the tool with your finger on the trigger.

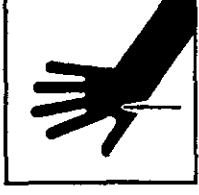

Use tool only for the intended application. When tool is ready for operation keep hands away from nosepiece area. Never point nosepiece at yourself or anyone else.

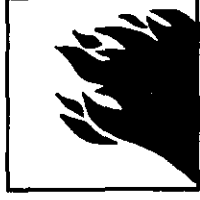

Do not damage housing of tool. No modifications of tool, fuel cell or battery charger are allowed. Do not place tool on oven or radiator, fuel cell in tool might burst. Observe temperature limit of max. 50°C of fuel cell.



Hold the tool in a way to avoid a recoil injuring your head or body. Beware! When working on stairs, ladders, roofs or when nailing crates always take a favourable position to the workpiece.

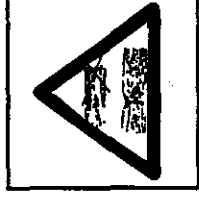

Watch your work place! Fasteners may fire through the work piece and slide sideways through the work piece thus endangering people. Only operate when holding the tool on the work piece.

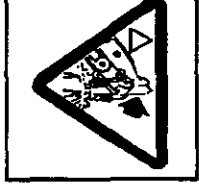

Tools being marked with an upside down equilateral triangle must be used only with a safety yoke. (work contacting element)



The impulse nailer should be operated only when it is in contact with the work surface. When fastening thin materials such as plywood, be sure to position the tool so that the fastener is driven into the underlying piece.

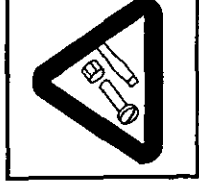

Periodically, check tension of all nuts and bolts on the tools.

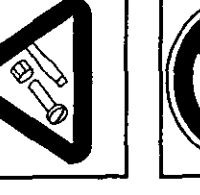

Maintenance should only be carried out by competent persons.



Don't smoke when handling fuel cell. Do not inhale its contents. Keep fuel cell valve stem away from face eyes or skin.

**Paslode**

Paslode Division, ITW Ltd.  
Queensway, Forestfach  
Swansea Sa5 4ED  
GREAT BRITAIN

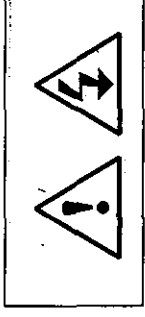

## Safety and Operating Instructions for Impulse Battery and Charging System

### IMPORTANT SAFETY INSTRUCTIONS

- 1) Before using battery charging system, read all instructions and cautionary markings on AC-DC Adapter, Charger Base, and Battery.
- 2) Charging system is designed for indoor use only. Do not expose charging system to rain or excessive moisture.
- 3) Make sure cord is located so that it will not be stepped on, tripped over, or otherwise subjected to damage or stress.
- 4) Do not operate charging system with damaged cord or plug- replace adapter immediately.
- 5) To reduce the risk of personal injury unplug the charging system from the outlet before cleaning the contacts. Clean contacts with a dry brush or equivalent only.
- 6) The charging system and battery are specifically designed to work together. Do not attempt to charge any other cordless tool or battery with this charger.
- 7) Do not attempt to charge Impulse battery with any other charging system, other than the Impulse charging system.
- 8) Do not short a battery. A shorted battery can produce high current which can lead to overheating and burns.
- 9) Do not recharge batteries at a temperature below 40°F (5°C) or above 104°F (40°C).
- 10) Do not allow metal objects to come into contact with battery terminals.
- 11) Do not puncture or attempt to open battery case or cells.
- 12) Do not store battery where it will be subjected to temperatures above 120°F (50°C).
- 13) Do not incinerate battery.
- 14) Do not use a defective battery charger, one that overheats and/or smokes when plugged in.
- 15) Insert and charge only one battery at a time.
- 16) Battery must be recycled or disposed of properly. Battery contains nickel-cadmium cells.

Declaration of Conformity



Paslode declares that this Charger System has been designed in compliance with the Regulations and Standards of 73/23/EEC and 89/336/EEC.

Rudolf Golsch

Paslode International

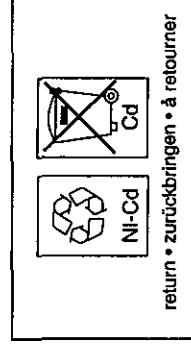

**OPERATING MANUAL**

The Impulse tool comes with a rechargeable battery and its own charging system. This battery and charging system combination is the only one that will work with Impulse tools.

**CHARGING PROCEDURE**

The battery must be charged before making use of a new Impulse Tool. New batteries are shipped discharged and must be charged before use. Each charging of the battery will take 5 minutes to 2 hours, depending on amount of discharge.

**NOTE: OPERATING MANUAL FOR 2 HOUR CHARGING SYSTEM (ORANGE):**

**IMPORTANT CHARGING NOTES**

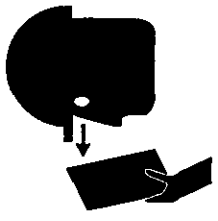
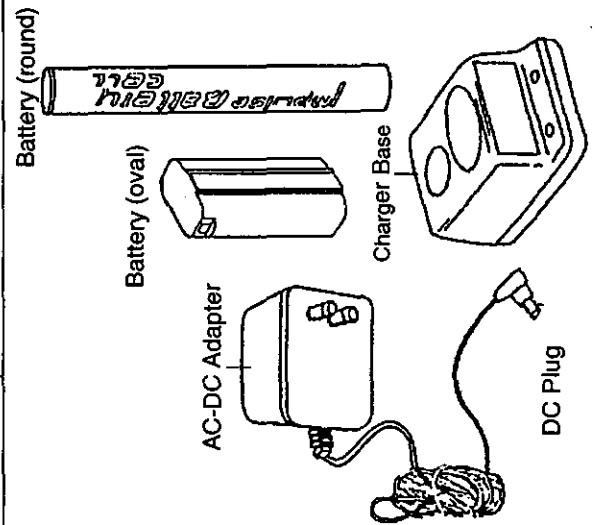
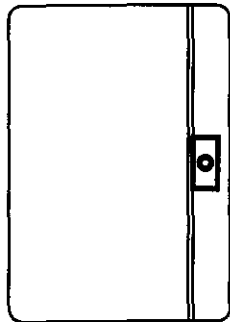
	<b>ATTENTION!</b>
<b>CHEMICAL/EXPLOSION HAZARD</b>	
Read all instructions before charging or using battery. Disregard of instructions may result in fire, burns or release of toxic materials.	
	
<b>IMPULSE BATTERY CHARGING SYSTEM</b>	
	
<b>REAR VIEW OF CHARGER BASE</b>	
Plug Receptacle	

**CHARGING INSTRUCTIONS:**

- Place the round DC plug of the adapter into the plug receptacle on the back of the orange charger base. Insert the adapter into the electric current outlet as specified in table below. A green light indicates power is on and charger is ready for use.
- Insert battery with terminals down into charger base. Charge one battery only at a time  
**Red light indicates that battery is charging.**  
The green light will turn off.

**Please Note**

If battery is completely discharged, the red and green lights may flash back and forth for up to 20 minutes. This safety feature slowly recharges the battery until it is ready to accept the full charging current. If the lights continue to flash after 20 minutes, replace the battery.

- After charging, the red light will turn off and the green light will come on, indicating that the battery is fully charged.  
The battery is ready for use!
- After charging is completed unplug DC plug and adapter.

**CHARGING TIMES FOR BATTERY:**

- First Charge 2 Hours
- Partially Charged Battery - 5 Min. to 2 Hours
- Completely Discharged Battery 2 Hours

**TECHNICAL DATA**

Impulse Adapter(AC-DC)	Part No.	Input	Output	Polarity
Europe	900505	230V, 50HZ	12VDC, 800mA	⊖ ⊕
Great Britain	900506	240V, 50HZ	12VDC, 800mA	⊖ ⊕
Australia	900504	240V, 50HZ	12VDC, 800mA	⊖ ⊕
USA/Canada	900477	120V, 60HZ	12VDC, 800mA	⊖ ⊕
Impulse Charger Base	900476	12VDC, 9.6VA	6VDC, 4.5VA	
Impulse Battery				
6VDC, 1300mAh, Nickel-cadmium	402500	IM200, IM250, IM300, IM325, IM350		(black)
Battery round	404717	IM250II, IM325CT, IM350CT		(orange)
Battery oval				

# PASLODE IMPULSE FUEL CELLS

Chemwatch Independent Material Safety Data Sheet

Issue Date: 28-Jul-2008

NC317ECP

CHEMWATCH 4919-89

Version No:8

CD 2010/1 Page 1 of 11

## Section 1 - CHEMICAL PRODUCT AND COMPANY IDENTIFICATION

**PRODUCT NAME**  
PASLODE IMPULSE FUEL CELLS

**SYNONYMS**  
"nail gun fuel supply"

**PROPER SHIPPING NAME**  
FUEL CELL CARTRIDGES or FUEL CELL CARTRIDGES CONTAINED IN EQUIPMENT or FUEL CELL CARTRIDGES IN EQUIPMENT, containing liquefied flammable gas

**PRODUCT USE**  
Fuel supply for Paslode nail guns.

**SUPPLIER**  
Company: Paslode Australia Pty  
Address:  
47- 55 Williamson Road  
Ingleburn  
NSW, 2565  
AUS  
Telephone: +61 2 9829 4000  
Fax: +61 2 9829 7788

## Section 2 - HAZARDS IDENTIFICATION

**STATEMENT OF HAZARDOUS NATURE**  
**DANGEROUS GOODS. NON-HAZARDOUS SUBSTANCE.** According to NOHSC Criteria, and ADG Code.

**POISONS SCHEDULE**  
None

**RISK**

- Extremely flammable.
- Risk of explosion if heated under confinement.

**SAFETY**

- Keep away from sources of ignition. No smoking.
- Do not breathe gas/ fumes/ vapour/ spray.
- Avoid contact with skin.
- Use only in well ventilated areas.
- Keep container in a well ventilated place.
- Keep container tightly closed.
- This material and its container must be disposed of as hazardous waste.

## Section 3 - COMPOSITION / INFORMATION ON INGREDIENTS

NAME	CAS RN	%
fuel nonhazardous proprietary propellant, as propylene	115-07-1	>60
NOTE: Manufacturer has supplied full ingredient information to allow CHEMWATCH assessment.		1-10

continued...

# PASLODE IMPULSE FUEL CELLS

Chemwatch Independent Material Safety Data Sheet

Issue Date: 28-Jul-2008

NC317ECP

CHEMWATCH 4919-89

Version No:8

CD 2010/1 Page 2 of 11

## Section 3 - COMPOSITION / INFORMATION ON INGREDIENTS

### Section 4 - FIRST AID MEASURES

#### SWALLOWED

- - If swallowed do NOT induce vomiting.
- If vomiting occurs, lean patient forward or place on left side (head-down position, if possible) to maintain open airway and prevent aspiration.
- Observe the patient carefully.
- Never give liquid to a person showing signs of being sleepy or with reduced awareness; i.e. becoming unconscious.
- Give water to rinse out mouth, then provide liquid slowly and as much as casualty can comfortably drink.
- Seek medical advice.

#### EYE

- If this product comes in contact with the eyes:
- Wash out immediately with fresh running water.
- Ensure complete irrigation of the eye by keeping eyelids apart and away from eye and moving the eyelids by occasionally lifting the upper and lower lids.
- Seek medical attention without delay; if pain persists or recurs seek medical attention.
- Removal of contact lenses after an eye injury should only be undertaken by skilled personnel.

#### SKIN

- If skin or hair contact occurs:
- Flush skin and hair with running water (and soap if available).
- Seek medical attention in event of irritation.

#### INHALED

- - If fumes or combustion products are inhaled remove from contaminated area.
- Lay patient down. Keep warm and rested.
- Prostheses such as false teeth, which may block airway, should be removed, where possible, prior to initiating first aid procedures.
- Apply artificial respiration if not breathing, preferably with a demand valve resuscitator, bag-valve mask device, or pocket mask as trained. Perform CPR if necessary.
- Transport to hospital, or doctor.

#### NOTES TO PHYSICIAN

- For acute or short term repeated exposures to petroleum distillates or related hydrocarbons:
- Primary threat to life, from pure petroleum distillate ingestion and/or inhalation, is respiratory failure.
- Patients should be quickly evaluated for signs of respiratory distress (e.g. cyanosis, tachypnoea, intercostal retraction, obtundation) and given oxygen. Patients with inadequate tidal volumes or poor arterial blood gases (pO<sub>2</sub> 50 mm Hg) should be intubated.
- Arrhythmias complicate some hydrocarbon ingestion and/or inhalation and electrocardiographic evidence of myocardial injury has been reported; intravenous lines and cardiac monitors should be established in obviously symptomatic patients. The lungs excrete inhaled solvents, so that hyperventilation improves clearance.
- A chest x-ray should be taken immediately after stabilisation of breathing and circulation to document aspiration and detect the presence of pneumothorax.
- Epinephrine (adrenalin) is not recommended for treatment of bronchospasm because of potential myocardial sensitisation to catecholamines. Inhaled cardioselective bronchodilators (e.g. Alupent, Salbutamol) are the preferred agents, with aminophylline a second choice.
- Lavage is indicated in patients who require decontamination; ensure use of cuffed endotracheal tube in adult patients. [Ellenhorn and Barceloux: Medical Toxicology].

continued...

# PASLODE IMPULSE FUEL CELLS

Chemwatch Independent Material Safety Data Sheet

Issue Date: 28-Jul-2008

NC317ECP

CHEMWATCH 4919-89

Version No:8

CD 2010/1 Page 3 of 11

## Section 5 - FIRE FIGHTING MEASURES

### EXTINGUISHING MEDIA

- - Water spray or fog.
- Foam.
- Dry chemical powder.
- BCF (where regulations permit).
- Carbon dioxide.

### FIRE FIGHTING

- - Alert Fire Brigade and tell them location and nature of hazard.
- May be violently or explosively reactive.
- Wear breathing apparatus plus protective gloves.
- Prevent, by any means available, spillage from entering drains or water course.
- If safe, switch off electrical equipment until vapour fire hazard removed.
- Use water delivered as a fine spray to control fire and cool adjacent area.
- DO NOT approach containers suspected to be hot.
- Cool fire exposed containers with water spray from a protected location.
- If safe to do so, remove containers from path of fire.
- Equipment should be thoroughly decontaminated after use.

### FIRE/EXPLOSION HAZARD

- - Liquid and vapour are highly flammable.
- Severe fire hazard when exposed to heat, flame and/or oxidisers.
- Vapour forms an explosive mixture with air.
- Severe explosion hazard, in the form of vapour, when exposed to flame or spark.
- Vapour may travel a considerable distance to source of ignition.
- Heating may cause expansion / decomposition with violent rupture of containers.
- On combustion, may emit toxic fumes of carbon monoxide (CO).  
Other combustion products include: carbon dioxide (CO<sub>2</sub>).

### FIRE INCOMPATIBILITY

- Avoid contamination with strong oxidising agents as ignition may result.

### HAZCHEM

2Y\*

### Personal Protective Equipment

Gas tight chemical resistant suit.

## Section 6 - ACCIDENTAL RELEASE MEASURES

### MINOR SPILLS

- - Clean up all spills immediately.
- Avoid breathing vapours and contact with skin and eyes.
- Wear protective clothing, impervious gloves and safety glasses.
- Shut off all possible sources of ignition and increase ventilation.
- Wipe up.
- If safe, damaged cans should be placed in a container outdoors, away from all ignition sources, until pressure has dissipated.
- Undamaged cans should be gathered and stowed safely.

### MAJOR SPILLS

- - Clear area of personnel and move upwind.
- Alert Fire Brigade and tell them location and nature of hazard.
- May be violently or explosively reactive.

continued...

# PASLODE IMPULSE FUEL CELLS

Chemwatch Independent Material Safety Data Sheet

Issue Date: 28-Jul-2008

NC317ECP

CHEMWATCH 4919-89

Version No:8

CD 2010/1 Page 4 of 11

## Section 6 - ACCIDENTAL RELEASE MEASURES

- Wear breathing apparatus plus protective gloves.
- Prevent, by any means available, spillage from entering drains or water courses
- No smoking, naked lights or ignition sources.
- Increase ventilation.
- Stop leak if safe to do so.
- Water spray or fog may be used to disperse / absorb vapour.
- Absorb or cover spill with sand, earth, inert materials or vermiculite.
- If safe, damaged cans should be placed in a container outdoors, away from ignition sources, until pressure has dissipated.
- Undamaged cans should be gathered and stowed safely.
- Collect residues and seal in labelled drums for disposal.

**Personal Protective Equipment advice is contained in Section 8 of the MSDS.**

## Section 7 - HANDLING AND STORAGE

### PROCEDURE FOR HANDLING

- Remove all ignition sources.
- Limit all unnecessary personal contact.
- Wear protective clothing when risk of exposure occurs.
- Use in a well-ventilated area.
- When handling DO NOT eat, drink or smoke.
- Always wash hands with soap and water after handling.
- Avoid physical damage to containers.
- Use good occupational work practice.
- Observe manufacturer's storing and handling recommendations.

### SUITABLE CONTAINER

Fuel cell cartridge.

### STORAGE INCOMPATIBILITY

- Avoid storage with oxidisers.

### STORAGE REQUIREMENTS

- - Store in original containers in approved flame-proof area.
- DO NOT store in pits, depressions, basements or areas where vapours may be trapped.
- No smoking, naked lights, heat or ignition sources.
- Keep containers securely sealed. Contents under pressure.
- Store away from incompatible materials.
- Store in a cool, dry, well ventilated area in an upright position.
- Avoid storage at temperatures higher than 40 deg C.
- Protect containers against physical damage and check regularly for leaks.
- Observe manufacturer's storing and handling recommendations.

## Section 8 - EXPOSURE CONTROLS / PERSONAL PROTECTION

### EXPOSURE CONTROLS

#### MATERIAL DATA

PASLODE IMPULSE FUEL CELLS:

Not available

#### PROPYLENE:

- May act as a simple asphyxiants; these are gases which, when present in high concentrations, reduce the

continued...

# PASLODE IMPULSE FUEL CELLS

Chemwatch Independent Material Safety Data Sheet

Issue Date: 28-Jul-2008

NC317ECP

CHEMWATCH 4919-89

Version No:8

CD 2010/1 Page 5 of 11

## Section 8 - EXPOSURE CONTROLS / PERSONAL PROTECTION

oxygen content in air below that required to support breathing, consciousness and life; loss of consciousness, with death by suffocation may rapidly occur in an oxygen deficient atmosphere.

CARE: Most simple asphyxiants are odourless or possess low odour and there is no warning on entry into an oxygen deficient atmosphere. If there is any doubt, oxygen content can be checked simply and quickly. It may not be appropriate to only recommend an exposure standard for simple asphyxiants rather it is essential that sufficient oxygen be maintained. Air normally has 21 percent oxygen by volume, with 18 percent regarded as minimum under normal atmospheric pressure to maintain consciousness / life. At pressures significantly higher or lower than normal atmospheric pressure, expert guidance should be sought.

NOTE: This substance has been classified by the ACGIH as A4 NOT classifiable as causing Cancer in humans.

### PERSONAL PROTECTION

#### EYE

- No special equipment for minor exposure i.e. when handling small quantities.
- OTHERWISE:
  - Safety glasses with side shields.
  - Contact lenses may pose a special hazard; soft contact lenses may absorb and concentrate irritants. A written policy document, describing the wearing of lens or restrictions on use, should be created for each workplace or task. This should include a review of lens absorption and adsorption for the class of chemicals in use and an account of injury experience. Medical and first-aid personnel should be trained in their removal and suitable equipment should be readily available. In the event of chemical exposure, begin eye irrigation immediately and remove contact lens as soon as practicable. Lens should be removed at the first signs of eye redness or irritation - lens should be removed in a clean environment only after workers have washed hands thoroughly. [CDC NIOSH Current Intelligence Bulletin 59].

#### HANDS/FEET

- - No special equipment needed when handling small quantities.
- OTHERWISE: Wear general protective gloves, eg. light weight rubber gloves. Or as required: Wear chemical protective gloves, eg. PVC. Wear safety footwear.

#### OTHER

- No special equipment needed when handling small quantities.

#### OTHERWISE:

- Overall.
- Barrier cream.
- Eyewash unit.

The local concentration of material, quantity and conditions of use determine the type of personal protective equipment required. For further information consult site specific CHEMWATCH data (if available), or your Occupational Health and Safety Advisor.

### ENGINEERING CONTROLS

- General exhaust is adequate under normal operating conditions. If risk of overexposure exists, wear SAA approved respirator. Correct fit is essential to obtain adequate protection. Provide adequate ventilation in warehouse or closed storage areas.

## Section 9 - PHYSICAL AND CHEMICAL PROPERTIES

### APPEARANCE

Compressed highly flammable liquified gas.

### PHYSICAL PROPERTIES

Liquid.  
Gas.

Does not mix with water.

continued...

# PASLODE IMPULSE FUEL CELLS

Chemwatch Independent Material Safety Data Sheet  
Issue Date: 28-Jul-2008  
NC317ECP

CHEMWATCH 4919-89  
Version No:8  
CD 2010/1 Page 6 of 11  
Section 9 - PHYSICAL AND CHEMICAL PROPERTIES

Floats on water.

State	Liquid	Molecular Weight	Not applicable
Melting Range (°C)	Not Available	Viscosity	Not Applicable
Boiling Range (°C)	Not Available	Solubility in water (g/L)	Partly miscible
Flash Point (°C)	- 108	pH (1% solution)	Not applicable
Decomposition Temp (°C)	Not Available	pH (as supplied)	Not applicable
Autoignition Temp (°C)	Not Available	Vapour Pressure (kPa)	Not available
Upper Explosive Limit (%)	Not Available	Specific Gravity (water=1)	0.7
Lower Explosive Limit (%)	Not Available	Relative Vapour Density (air=1)	>1
Volatile Component (%vol)	100	Evaporation Rate	Not available

## Section 10 - CHEMICAL STABILITY AND REACTIVITY INFORMATION

### CONDITIONS CONTRIBUTING TO INSTABILITY

- - Elevated temperatures.
  - Presence of open flame.
  - Product is considered stable.
  - Hazardous polymerisation will not occur.
- For incompatible materials - refer to Section 7 - Handling and Storage.*

## Section 11 - TOXICOLOGICAL INFORMATION

### POTENTIAL HEALTH EFFECTS

#### ACUTE HEALTH EFFECTS

##### SWALLOWED

- Considered an unlikely route of entry in commercial/industrial environments. Not normally a risk due to extreme volatility of liquid.

##### EYE

- The gas is non-irritating to the eyes but may cause severe cold burns.

##### SKIN

- Vapourising liquid causes rapid cooling and contact may cause cold burns, frostbite, even through normal gloves. Frozen skin tissues are painless and appear waxy and yellow. Signs and symptoms of frost-bite may include "pins and needles", paleness followed by numbness, a hardening or stiffening of the skin, a progression of colour changes in the affected area, (first white, then mottled and blue and eventually black; on recovery, red, hot, painful and blistered).

##### INHALED

- The vapour is a simple asphyxiant (precludes access to oxygen). Acute effects from inhalation of high concentrations of gas/vapour are pulmonary irritation, including coughing, with nausea; central nervous system depression - characterised by headache and dizziness, increased reaction time, fatigue and loss of co-ordination.  
**WARNING:**Intentional misuse by concentrating/inhaling contents may be lethal. Not considered an irritant through normal use. Inhalation may cause cardiac sensitisation.

##### CHRONIC HEALTH EFFECTS

- Primary route of exposure is usually by inhalation of the gas. As with any chemical product, contact with unprotected bare skin; inhalation of vapour, mist or dust in work place atmosphere; or ingestion in any form, should be avoided by observing good occupational work practice.

continued...

# PASLODE IMPULSE FUEL CELLS

Chemwatch Independent Material Safety Data Sheet

Issue Date: 28-Jul-2008

NC317ECP

CHEMWATCH 4919-89

Version No:8

CD 2010/1 Page 7 of 11

Section 11 - TOXICOLOGICAL INFORMATION

## TOXICITY AND IRRITATION

- Not available. Refer to individual constituents.

## PROPYLENE:

- unless otherwise specified data extracted from RTECS - Register of Toxic Effects of Chemical Substances.

- No significant acute toxicological data identified in literature search.

The substance is classified by IARC as Group 3:

NOT classifiable as to its carcinogenicity to humans.

Evidence of carcinogenicity may be inadequate or limited in animal testing.

## CARCINOGEN

Propylene

International Agency  
for Research on Cancer  
(IARC) - Agents  
Reviewed by the IARC  
Monographs

Group

3

## Section 12 - ECOLOGICAL INFORMATION

Refer to data for ingredients, which follows:

### PROPYLENE:

#### PASLODE IMPULSE FUEL CELLS:

- DO NOT discharge into sewer or waterways.

#### PASLODE IMPULSE FUEL CELLS:

Marine Pollutant: Not Determined

### PROPYLENE:

- log Kow (Prager 1995): 1.77
- Half- life Soil - High (hours): 672
- Half- life Soil - Low (hours): 168
- Half- life Air - High (hours): 13.7
- Half- life Air - Low (hours): 1.7
- Half- life Surface water - High (hours): 672
- Half- life Surface water - Low (hours): 168
- Half- life Ground water - High (hours): 1344
- Half- life Ground water - Low (hours): 336
- Aqueous biodegradation - Aerobic - High (hours): 672
- Aqueous biodegradation - Aerobic - Low (hours): 168
- Aqueous biodegradation - Anaerobic - High (hours): 2688
- Aqueous biodegradation - Anaerobic - Low (hours): 672
- Photooxidation half- life water - High (hours): 43000
- Photooxidation half- life water - Low (hours): 1070
- Photooxidation half- life air - High (hours): 13.7
- Photooxidation half- life air - Low (hours): 1.7

- Substances containing unsaturated carbons are ubiquitous in indoor environments. They result from many sources (see below). Most are reactive with environmental ozone and many produce stable products which are thought to adversely affect human health. The potential for surfaces in an enclosed space to facilitate reactions should be considered.

continued...

# PASLODE IMPULSE FUEL CELLS

Chemwatch Independent Material Safety Data Sheet

Issue Date: 28-Jul-2008

NC317ECP

CHEMWATCH 4919-89

Version No:8

CD 2010/1 Page 8 of 11

## Section 12 - ECOLOGICAL INFORMATION

Source of unsaturated substances	Unsaturated substances (Reactive Emissions)	Major Stable Products produced following reaction with ozone.
Occupants (exhaled breath, ski oils, personal care products)	Isoprene, nitric oxide, squalene, unsaturated sterols, oleic acid and other unsaturated fatty acids, unsaturated oxidation products	Methacrolein, methyl vinyl ketone, nitrogen dioxide, acetone, 6MHQ, geranyl acetone, 4OPA, formaldehyde, nonanal, decanal, 9- oxo- nonanoic acid, azelaic acid, nonanoic acid.
Soft woods, wood flooring, including cypress, cedar and silver fir boards, houseplants	Isoprene, limonene, alpha-pinene, other terpenes and sesquiterpenes	Formaldehyde, 4- AMC, pinoaldehyde, pinic acid, pinonic acid, formic acid, methacrolein, methyl vinyl ketone, SOAs including ultrafine particles
Carpets and carpet backing	4- Phenylcyclohexene, 4- vinylcyclohexene, styrene, 2- ethylhexyl acrylate, unsaturated fatty acids and esters	Formaldehyde, hexanal, nonanal, benzaldehyde, hexanal, nonanal, 2- nonenal
Linoleum and paints/polishes containing linseed oil	Linoleic acid, linolenic acid	
Latex paint Certain cleaning products, polishes, waxes, air fresheners	Residual monomers Limonene, alpha- pinene, terpinolene, alpha- terpineol, linalool, linalyl acetate and other terpenoids, longifolene and other sesquiterpenes	Propanal, hexanal, nonanal, 2- heptenal, 2- nonenal, 2- decenal, 1- pentene- 3- one, propionic acid, n- butyric acid Formaldehyde
Natural rubber adhesive	Isoprene, terpenes	Formaldehyde, acetaldehyde, glycoaldehyde, formic acid, acetic acid, hydrogen and organic peroxides, acetone, benzaldehyde, 4- hydroxy- 4- methyl- 5- hexen- 1- al, 5- ethenyl- dihydro- 5- methyl- 2(3H)- furanone, 4- AMC, SOAs including ultrafine particles
Photocopier toner, printed paper, styrene polymers Environmental tobacco smoke	Styrene	Formaldehyde, methacrolein, methyl vinyl ketone Formaldehyde, benzaldehyde
Soiled clothing, fabrics, bedding	Styrene, acrolein, nicotine	Formaldehyde, benzaldehyde, hexanal, glyoxal, N- methylformamide, nicotinaldehyde, cotinine
Soiled particle filters	Squalene, unsaturated sterols, oleic acid and other saturated fatty acids Unsaturated fatty acids from plant waxes, leaf litter, and other vegetative debris; soot; diesel particles	Acetone, geranyl acetone, 6MHO, 4OPA, formaldehyde, nonanal, decanal, 9- oxo- nonanoic acid, azelaic acid, nonanoic acid Formaldehyde, nonanal, and other aldehydes; azelaic acid; nonanoic acid; 9- oxo- nonanoic acid and other oxo- acids; compounds with mixed functional groups (=O, - OH, and - COOH) C5 to C10 aldehydes
Ventilation ducts and duct liners	Unsaturated fatty acids and esters, unsaturated oils, neoprene	
" Urban grime"	Polycyclic aromatic hydrocarbons	Oxidized polycyclic aromatic hydrocarbons

continued...

# PASLODE IMPULSE FUEL CELLS

Chemwatch Independent Material Safety Data Sheet  
Issue Date: 28-Jul-2008  
NC317ECP

CHEMWATCH 4919-89  
Version No:8  
CD 2010/1 Page 9 of 11  
Section 12 - ECOLOGICAL INFORMATION

Perfumes, colognes, essential oils (e.g. lavender, eucalyptus, tea tree)

Limonene, alpha-pinene, linalool, linalyl acetate, terpinene-4-ol, gamma-terpinene

Formaldehyde, 4-AMC, acetone, 4-hydroxy-4-methyl-5-hexen-1-ol, 5-ethenyl-dihydro-5-methyl-2(3H)furanone, SOAs including ultrafine particles

Overall home emissions

Limonene, alpha-pinene, styrene

Formaldehyde, 4-AMC, pinonaldehyde, acetone, pinic acid, pinonic acid, formic acid, benzaldehyde, SOAs including ultrafine particles

Abbreviations: 4-AMC, 4-acetyl-1-methylcyclohexene; 6MHQ, 6-methyl-5-heptene-2-one, 4OPA, 4-oxopentanal, SOA, Secondary Organic Aerosols

Reference: Charles J Weschler; Environmental Health Perspectives, Vol 114, October 2006.

■ For propene:

Koc : 219-237

Half-life (hr) air : 7.7

BCF : 13-31

Fish:LC50 (96 h): 8.4-9.6 mg/L

Invertebrate LC50 (96 h): 1.8-13 mg/L

Degradation Biological: significant

Abiotic processes: photodecomposes.

## Ecotoxicity

Ingredient

propylene

Persistence:  
Water/Soil  
LOW

Persistence: Air  
LOW

Bioaccumulation  
LOW

Mobility

## Section 13 - DISPOSAL CONSIDERATIONS

- - Recycle wherever possible or consult manufacturer for recycling options.
- Consult State Land Waste Management Authority for disposal.
- Bury residue in an authorised landfill.
- Recycle containers if possible, or dispose of in an authorised landfill.

## Section 14 - TRANSPORTATION INFORMATION

Labels Required: FLAMMABLE GAS

**HAZCHEM:**  
2Y\* (ADG7)

**ADG7:**

Class or division: 2.1

UN No.: 3478

Special provisions: 328; 338

Limited quantities: 120 ml

Subsidiary risk: None  
UN packing group: None  
Packing Instructions: None  
Portable tanks and bulk containers - None

Portable tanks and bulk containers - Special provisions: None

Instructions: Packagings and IBCs - P004  
Packing instruction:

Packagings and IBCs - Special packing provisions: None

Shipping Name: FUEL CELL CARTRIDGES or FUEL CELL CARTRIDGES CONTAINED

continued...



# PASLODE IMPULSE FUEL CELLS

Chemwatch Independent Material Safety Data Sheet

Issue Date: 28-Jul-2008

NC317ECP

CHEMWATCH 4919-89

Version No:8

CD 2010/1 Page 11 of 11

Section 16 - OTHER INFORMATION

*This is the end of the MSDS.*

# SANYO NICKEL CADMIUM BATTERY, RECHARGEABLE

Chemwatch Material Safety Data Sheet  
Issue Date: 21-Jul-2008  
NC317ECP

CHEMWATCH 7134-83  
Version No:2.0  
CD 2008/2 Page 1 of 21

## Section 1 - CHEMICAL PRODUCT AND COMPANY IDENTIFICATION

**PRODUCT NAME**  
SANYO NICKEL CADMIUM BATTERY, RECHARGEABLE

### SYNONYMS

CADNICA, nickel, cadmium, battery, rechargeable

### PRODUCT USE

Rechargeable battery. Sealed battery is Nonhazardous. The Risk codes are for exposure to hazardous battery contents.

### SUPPLIER

Company: Sanyo Energy  
Address:  
2055 SANYO AVE.  
SAN DIEGO,  
CA, 92154  
USA  
Telephone: +1 619 661 4888

## Section 2 - HAZARDS IDENTIFICATION

**STATEMENT OF HAZARDOUS NATURE**  
**HAZARDOUS SUBSTANCE. NON-DANGEROUS GOODS. According to the Criteria of**  
**NOHSC, and the ADG Code.**

### POISONS SCHEDULE

None

### RISK

Harmful in contact with skin.  
Very toxic by inhalation.

Causes burns.

Risk of serious damage to eyes.

May cause SENSITISATION by skin contact.

May cause CANCER.

Toxic: danger of serious damage to health by prolonged exposure through inhalation and if swallowed.

Very toxic to aquatic organisms may cause long- term adverse effects in the aquatic environment.

Possible risk of impaired fertility.

Possible risk of harm to the unborn child.

Possible risk of irreversible effects.

### SAFETY

In case of insufficient ventilation wear suitable respiratory equipment.

Use only in well ventilated areas.

Keep container in a well ventilated place.

Avoid exposure - obtain special instructions before use.

To clean the floor and all objects contaminated by this material use water and detergent.

This material and its container must be disposed of in a safe way.

Keep away from food drink and animal feeding stuffs.

Take off immediately all contaminated clothing.

In case of accident or if you feel unwell

IMMEDIATELY contact Doctor or Poisons

Information Centre (show label if possible).

Use appropriate container to avoid environment contamination.

Avoid release to the environment. Refer to

continued...

# SANYO NICKEL CADMIUM BATTERY, RECHARGEABLE

Chemwatch Material Safety Data Sheet  
Issue Date: 21-Jul-2008  
NC317ECP

CHEMWATCH 7134-83  
Version No:2.0

CD 2008/2 Page 3 of 21  
Section 4 - FIRST AID MEASURES

resuscitator, bag-valve mask device, or pocket mask as trained. Perform CPR if necessary.  
- Transport to hospital, or doctor, without delay.

## NOTES TO PHYSICIAN

- High acute exposure, to cadmium, produces delayed pulmonary oedema progressing to interstitial fibrosis.
  - For acute inhalations, initial presentation simulates metal fume fever (fever, headache, dyspnoea, pleuritic chest pain, conjunctivitis, rhinitis, sore throat, cough) developing 4-12 hours post-exposure. Respiratory failure may ensue in 3-10 days.
  - For acute oral exposures, gastroenteritis results with sudden onset of vomiting, diarrhoea and abdominal pain.
  - If vomiting is not prominent, use ipecac/lavage/catharsis in usual manner.
  - CaNa2EDTA is the chelator of choice for acute cadmium exposure. British Anti-Lewisite increases nephrotoxicity and therefore is not indicated [Ellenhorn and Barceloux: Medical Toxicology]
- COMMENTS on HUMAN TOXICITY:**
- Between 10 and 50% of inhaled cadmium is adsorbed, the adsorption being greater for smaller particles and fumes; absorption through skin is negligible.
  - The half-life of cadmium in the human body is thought to be about around 30 years and it has no known biological function.
- Blood and urine cadmium concentrations may be determined.

## Normal concentrations

Blood <27 nmol/l (<3ug/l), non- smokers <54 nmol/l (<6 ug/l), smokers  
Urine <18 nmol/l (<2 ug/l), non- smokers  
0.4- 1.3 nmol/mmol creatinine <45 nmol/l (<5 ug/l), smokers 10- 35 nmol/mmol creatinine

## Hazardous concentrations

>180 nmol/l (>20 ug/l)  
>180 nmol/l (>20 ug/l) >4- 13 nmol/mmol creatinine

## BIOLOGICAL EXPOSURE INDEX (BEI)

These represent the determinants observed in specimens collected from a healthy worker exposed at the Exposure Standard (ES or TLV):

Determinant	Sampling time	Index	Comments
Cadmium in urine	Not critical	5 ug/g creatinine	B
Cadmium in blood	Not critical	5 ug/L	B

- B: Background levels occur in specimens collected from subjects NOT exposed.
- In cases of nickel poisoning, dimercaptol delivered by deep intramuscular injection may be a suitable antidote. (Patients should not exhibit renal or hepatic dysfunction.) The use of diethyldithiocarbamate is the subject of ongoing research.
  - Irritant contact dermatoses or eczemas may respond to applications of weak antiseptic packs, antibiotic ointments (tetracycline or erythromycin) or inert pastes and ointments. Systemic antibiotics are advisable in the presence of lymphangitis or lymphadenitis.

## Section 5 - FIRE FIGHTING MEASURES

### EXTINGUISHING MEDIA

- Water spray or fog.
- Foam.
- Dry chemical powder.

continued...

# SANYO NICKEL CADMIUM BATTERY, RECHARGEABLE

Chemwatch Material Safety Data Sheet

Issue Date: 21-Jul-2008

NC317ECP

CHEMWATCH 7134-83

Version No:2.0

CD 2008/2 Page 5 of 21

Section 7 - HANDLING AND STORAGE

- Always wash hands with soap and water after handling.
- Work clothes should be laundered separately.
- Use good occupational work practice.
- Observe manufacturer's storing and handling recommendations.
- Atmosphere should be regularly checked against established exposure standards to ensure safe working conditions are maintained.

## SUITABLE CONTAINER

Carton.

## STORAGE INCOMPATIBILITY

None known.

## STORAGE REQUIREMENTS

- Keep dry.
- Store under cover.
- Protect containers against physical damage.
- Observe manufacturer's storing and handling recommendations.

## Section 8 - EXPOSURE CONTROLS / PERSONAL PROTECTION

### EXPOSURE CONTROLS

Source	Material	TWA mg/m <sup>3</sup>	Peak mg/m <sup>3</sup>
Australia Exposure Standards	cadmium (Cadmium and compounds (as Cd))	0.01	
Australia Exposure Standards	cadmium hydroxide (Cadmium and compounds (as Cd))	0.01	
Australia Exposure Standards	nickel (Nickel, metal)	1	2
Australia Exposure Standards	potassium hydroxide (Potassium hydroxide)		
Australia Exposure Standards	nylon (Inspirable dust (not otherwise classified))	10	

The following materials had no OELs on our records

- nickel(II) hydroxide: CAS:12054-48-7 CAS:36897-37-7

### EMERGENCY EXPOSURE LIMITS

Material	Revised IDLH Value (mg/m3)	Revised IDLH Value (ppm)
cadmium	9	
nickel	10	
nickel(II) hydroxide	10	

### MATERIAL DATA

Not available. Refer to individual constituents.

### INGREDIENT DATA

NICKEL:

POTASSIUM HYDROXIDE:

It is the goal of the ACGIH (and other Agencies) to recommend TLVs (or their equivalent) for all substances for which there is evidence of health effects at airborne concentrations encountered in the workplace.

At this time no TLV has been established, even though this material may produce adverse health effects (as evidenced in animal experiments or clinical experience). Airborne concentrations must be maintained as low as is practically possible and

continued...

# SANYO NICKEL CADMIUM BATTERY, RECHARGEABLE

Chemwatch Material Safety Data Sheet

Issue Date: 21-Jul-2008

NC317ECP

CHEMWATCH 7134-83

Version No:2.0

CD 2008/2 Page 7 of 21  
Section 8 - EXPOSURE CONTROLS / PERSONAL PROTECTION

category system based on intensive odour, local irritation, and elimination half-life. However this system is being replaced to be consistent with the European Union (EU) Scientific Committee for Occupational Exposure Limits (SCOEL); this is more closely allied to that of the USA.

OSHA (USA) concluded that exposure to sensory irritants can:

- cause inflammation
- cause increased susceptibility to other irritants and infectious agents
- lead to permanent injury or dysfunction
- permit greater absorption of hazardous substances and
- acclimate the worker to the irritant warning properties of these substances thus increasing the risk of overexposure.

The TLV-TWA is protective against respiratory tract irritation produced at higher concentrations.

## PERSONAL PROTECTION

### EYE

- Chemical goggles.
- Full face shield may be required for supplementary but never for primary protection of eyes
- Contact lenses may pose a special hazard; soft contact lenses may absorb and concentrate irritants. A written policy document, describing the wearing of lens or restrictions on use, should be created for each workplace or task. This should include a review of lens absorption and adsorption for the class of chemicals in use and an account of injury experience. Medical and first-aid personnel should be trained in their removal and suitable equipment should be readily available. In the event of chemical exposure, begin eye irrigation immediately and remove contact lens as soon as practicable. Lens should be removed at the first signs of eye redness or irritation - lens should be removed in a clean environment only after workers have washed hands thoroughly. [CDC NIOSH Current Intelligence Bulletin 59].

### HANDS/FEET

- Wear chemical protective gloves, eg. PVC.
- Wear safety footwear or safety gumboots, eg. Rubber.

### NOTE:

- The material may produce skin sensitisation in predisposed individuals. Care must be taken, when removing gloves and other protective equipment, to avoid all possible skin contact.
- Contaminated leather items, such as shoes, belts and watch-bands should be removed and destroyed.

### OTHER

- Overalls.
- P.V.C. apron.
- Barrier cream.
- Skin cleansing cream.
- Eye wash unit.

The local concentration of material, quantity and conditions of use determine the type of personal protective equipment required.

For further information consult site specific

CHEMWATCH data (if available), or your Occupational Health and Safety Advisor.

## ENGINEERING CONTROLS

General exhaust is adequate under normal operating conditions. If risk of overexposure exists, wear SAA approved respirator. Correct fit is essential to obtain adequate protection. Provide adequate ventilation in warehouse or closed storage areas.

continued...

# SANYO NICKEL CADMIUM BATTERY, RECHARGEABLE

Chemwatch Material Safety Data Sheet

Issue Date: 21-Jul-2008

NC317ECP

CHEMWATCH 7134-83

Version No:2.0

CD 2008/2 Page 9 of 21

## Section 11 - TOXICOLOGICAL INFORMATION

Entry into the blood-stream, through, for example, cuts, abrasions or lesions, may produce systemic injury with harmful effects. Examine the skin prior to the use of the material and ensure that any external damage is suitably protected.

### INHALED

Not normally a hazard due to non-volatile nature of product.

Cadmium is absorbed more from the respiratory tract than the intestinal tract. Staging of symptoms include an initial, acute swelling of the lungs, followed by inflammation of the lungs after several days and chronic permanent scarring. 40mg of cadmium with 4mg retention in the lungs in humans will probably cause death. Accumulation of cadmium in the kidney can also cause permanent damage, even after a single intravenous dose.

### CHRONIC HEALTH EFFECTS

Repeated or prolonged exposure to corrosives may result in the erosion of teeth, inflammatory and ulcerative changes in the mouth and necrosis (rarely) of the jaw. Bronchial irritation, with cough, and frequent attacks of bronchial pneumonia may ensue. Gastrointestinal disturbances may also occur. Chronic exposures may result in dermatitis and/or conjunctivitis.

Skin contact with the material is more likely to cause a sensitisation reaction in some persons compared to the general population.

Ample evidence from experiments exists that there is a suspicion this material directly reduces fertility.

Based on experience with animal studies, exposure to the material may result in toxic effects to the development of the foetus, at levels which do not cause significant toxic effects to the mother.

Laboratory (in vitro) and animal studies show, exposure to the material may result in a possible risk of irreversible effects, with the possibility of producing mutation. Substance accumulation, in the human body, may occur and may cause some concern following repeated or long-term occupational exposure.

There is some evidence that inhaling this product is more likely to cause a sensitisation reaction in some persons compared to the general population.

Chronic cadmium poisoning causes softening of the bones, reduced bone density, kidney stones and increased blood pressure. There may be cardiovascular disease and a yellow ring in the tooth structure. Repeated or prolonged exposure can lead to loss of smell, ulcers in the nose, emphysema and mild anaemia. The risk of prostate, respiratory, bowel and genito-urinary cancers may be increased in humans.

### TOXICITY AND IRRITATION

Not available. Refer to individual constituents.

#### CADMIUM:

unless otherwise specified data extracted from RTECS - Register of Toxic Effects of Chemical Substances.

#### TOXICITY

Inhalation (human) LCLo: 39 mg/m<sup>3</sup>/20m

Inhalation (man) TCLo: 88 ug/m<sup>3</sup>/8.6y

Inhalation (rat) LC50: 25 mg/m<sup>3</sup>/30m

Oral (rat) LD50: 225 mg/kg

Oral (rabbit) LDLo: 70 mg/kg

IRRITATION

Nil Reported

#### CADMIUM HYDROXIDE:

No significant acute toxicological data identified in literature search.

#### NICKEL:

unless otherwise specified data extracted from RTECS - Register of Toxic Effects of Chemical Substances.

#### TOXICITY

Oral (rat) LDLo: 5000 mg/kg

Oral (rat) TDLo: 500 mg/kg/5D-1

IRRITATION

continued...

# SANYO NICKEL CADMIUM BATTERY, RECHARGEABLE

Chemwatch Material Safety Data Sheet

Issue Date: 21-Jul-2008

NC317ECP

CHEMWATCH 7134-83

Version No:2.0

CD 2008/2 Page 11 of 21

Section 11 - TOXICOLOGICAL INFORMATION

is characterised by dyspnea, cough and mucus production. The material may produce moderate eye irritation leading to inflammation. Repeated or prolonged exposure to irritants may produce conjunctivitis. The material may cause severe skin irritation after prolonged or repeated exposure and may produce on contact skin redness, swelling, the production of vesicles, scaling and thickening of the skin. Repeated exposures may produce severe ulceration.

## NYLON:

No significant acute toxicological data identified in literature search.

MATERIAL	CARCINOGEN	REPROTOXIN	SENSITISER	SKIN
cadmium	IARC:1 NTPA	ILOM ILOEI		
cadmium hydroxide	NTPA			
nickel	IARC:2B NTPB	ILOM ILOEI		
nickel(II) hydroxide	IARC:1			
<b>CARCINOGEN</b>				
IARC: International Agency for Research on Cancer (IARC) Carcinogens: cadmium Category: WARNING: This substance has been classified by the IARC as Group 1: CARCINOGENIC TO HUMANS.				
<b>CARCINOGEN</b>				
NTPA: US National Toxicology Program (NTP) 11th Report Part A Known to be Human Carcinogens: cadmium Category: REPROTOXIN				
ILOM: ILO Agents toxic to the male reproductive system: cadmium				
<b>REPROTOXIN</b>				
ILOEI: ILO Chemicals in the electronics industry that have toxic effects on reproduction: cadmium				
<b>CARCINOGEN</b>				
NTPA: US National Toxicology Program (NTP) 11th Report Part A Known to be Human Carcinogens: cadmium hydroxide Category: CARCINOGEN				
IARC: International Agency for Research on Cancer (IARC) Carcinogens: nickel Category: WARNING: This substance has been classified by the IARC as Group 2B: Possibly Carcinogenic to Humans.				
<b>CARCINOGEN</b>				
NTPB: US National Toxicology Program (NTP) 11th Report Part B. Reasonably Anticipated to be a Human Carcinogen: nickel Category: REPROTOXIN				
ILOM: ILO Agents toxic to the male reproductive system: nickel				
<b>REPROTOXIN</b>				
ILOEI: ILO Chemicals in the electronics industry that have toxic effects on reproduction: nickel				
<b>CARCINOGEN</b>				
IARC: International Agency for Research on Cancer (IARC) Carcinogens: nickel(II) hydroxide Category: WARNING: This substance has been classified by the IARC as Group 1: CARCINOGENIC TO HUMANS.				

## Section 12 - ECOLOGICAL INFORMATION

Do NOT allow product to come in contact with surface waters or to intertidal areas below the mean high water mark. Do not contaminate water when cleaning equipment or disposing of equipment wash-waters.

Wastes resulting from use of the product must be disposed of on site or at approved waste sites.

Metal-containing inorganic substances generally have negligible vapour pressure and are

continued...

# SANYO NICKEL CADMIUM BATTERY, RECHARGEABLE

Chemwatch Material Safety Data Sheet  
Issue Date: 21-Jul-2008  
NC317ECP

CHEMWATCH 7134-83

Version No:2.0

CD 2008/2 Page 13 of 21

## Section 12 - ECOLOGICAL INFORMATION

and bioconcentrate in the food chain. Biomagnification in terrestrial food chains is not expected.

Cadmium is more mobile in aquatic environments than most other heavy metals (e.g., lead). In most natural surface waters, the affinities of complexing ligands for cadmium generally follow the order of humic acids > CO<sub>3</sub><sup>2-</sup> > OH<sup>-</sup> > Cl<sup>-</sup> > SO<sub>4</sub><sup>2-</sup>. In unpolluted natural waters, most cadmium transported in the water column will exist in the dissolved state as the hydrated ion Cd(H<sub>2</sub>O)<sub>6</sub><sup>2+</sup>. Minor amounts of cadmium are transported with the coarse particulates, and only a small fraction is transported with the colloids. In unpolluted waters, cadmium can be removed from solution by exchange of cadmium for calcium in the lattice structure of carbonate minerals. In polluted organic-rich waters, adsorption of cadmium by humic substances and other organic complexing agents plays a dominant role in transport, partitioning, and remobilization of cadmium. Cadmium concentration in water is inversely related to the pH and the concentration of organic material in the water. Because cadmium exists only in the +2 oxidation state in water, aqueous cadmium is not strongly influenced by the oxidizing or reducing potential of the water. However, under reducing conditions, cadmium may form cadmium sulfide, which is poorly soluble and tends to precipitate. Free (ionic) cadmium seems to be the toxic form and becomes much more prevalent at low salinity. Cadmium has a relatively long residence time in aquatic systems. In Lake Michigan, a mean residence time of 4-10 years was calculated for cadmium compared to 22 years calculated for mercury. Precipitation and sorption to mineral surfaces, hydrous metal oxides, and organic materials are the most important processes for removal of cadmium to bed sediments. Humic acid is the major component of sediment responsible for adsorption. Sorption increases as the pH increases.

Sediment bacteria may also assist in the partitioning of cadmium from water to sediments. Both cadmium-sensitive and cadmium-resistant bacteria reduced the cadmium concentration in the water column from 1 ppm to between 0.2 and 0.6 ppm, with a corresponding increase in cadmium concentration in the sediments in the simulated environment. Studies indicate that concentrations of cadmium in sediments are at least one order of magnitude higher than in the overlying water. The mode of sorption of cadmium to sediments is important in determining its disposition to remobilize. Cadmium associated with carbonate minerals, precipitated as stable solid compounds or co-precipitated with hydrous iron oxides, is less likely to be mobilized by resuspension of sediments or biological activity. Cadmium that is adsorbed to mineral surfaces such as clay, or to organic materials, is more easily bioaccumulated or released in the dissolved state when the sediment is disturbed. Cadmium may redissolve from sediments under varying ambient conditions of pH, salinity, and redox potential. Cadmium is not known to form volatile compounds in the aquatic environment, so partitioning from water to the atmosphere does not occur.

In soils, pH, oxidation-reduction reactions, and formation of complexes are important factors affecting the mobility of cadmium. Cadmium can participate in exchange reactions on the negatively charged surface of clay minerals. In acid soils, the reaction is reversible. However, adsorption increases with pH and may become irreversible. Cadmium also may precipitate as insoluble cadmium compounds, or form complexes or chelates by interaction with organic matter. Available data suggest that organic matter is more effective than inorganic constituents in keeping cadmium unavailable. Examples of cadmium compounds found in soil are Cd<sub>3</sub>(PO<sub>4</sub>)<sub>2</sub>, CdCO<sub>3</sub>, and Cd(OH)<sub>2</sub>. These compounds are formed as the pH rises. It has been found that about 90% of cadmium in soils remains in the top 15 cm.

Aquatic and terrestrial organisms bioaccumulate cadmium. Cadmium concentrates in freshwater and marine animals to concentrations hundreds to thousands of times higher than in the water. Reported bioconcentration factors (BCFs) range from 113 to 18,000 for invertebrates, from 3 to 4,190 for fresh water aquatic organisms, and from 5 to 3,160 for saltwater aquatic organisms. Bioconcentration in fish depends on the pH and the humus content of the water. Cadmium (not an estrogen mimic) has also been shown to cause increased vitellogenesis in female Atlantic croaker (*Micropogonias undulatus*), but this is thought to be caused by direct toxic action on the pituitary, leading to altered secretion of gonadotropin hormone. Because of their high ability to accumulate metals, some aquatic plants have been suggested for use in pollution control. For example, it has been suggested that the rapidly-growing water hyacinth *Eichhornia crassipes* could be used

continued...

# SANYO NICKEL CADMIUM BATTERY, RECHARGEABLE

Chemwatch Material Safety Data Sheet  
Issue Date: 21-Jul-2008  
NC317ECP

CHEMWATCH 7134-83

Version No:2.0

CD 2008/2 Page 15 of 21

## Section 12 - ECOLOGICAL INFORMATION

cadmium with a resultant protective action against its toxic effects.

Significant compartments for soluble cadmium salts are likely to be soil and water. Cadmium(II) adsorbs to sediments. Once in an aquatic environment cadmium is highly mobile; its dissolved species are highly labile and are first to be released, for example, when salinity is increased in estuaries. In fresh water, cadmium toxicity is influenced by water hardness (the harder the water, the lower the toxicity). Cadmium can bioaccumulate and bioconcentrate in the food chain. Biomagnification in terrestrial food chains is not expected.

Cadmium is more mobile in aquatic environments than most other heavy metals (e.g., lead). In most natural surface waters, the affinities of complexing ligands for cadmium generally follow the order of humic acids > CO<sub>3</sub><sup>2-</sup> > OH<sup>-</sup> > Cl<sup>-</sup> > SO<sub>4</sub><sup>2-</sup>. In unpolluted natural waters, most cadmium transported in the water column will exist in the dissolved state as the hydrated ion Cd(H<sub>2</sub>O)<sub>6</sub><sup>2+</sup>. Minor amounts of cadmium are transported with the coarse particulates, and only a small fraction is transported with the colloids. In unpolluted waters, cadmium can be removed from solution by exchange of cadmium for calcium in the lattice structure of carbonate minerals. In polluted organic-rich waters, adsorption of cadmium by humic substances and other organic complexing agents plays a dominant role in transport, partitioning, and remobilization of cadmium. Cadmium concentration in water is inversely related to the pH and the concentration of organic material in the water. Because cadmium exists only in the +2 oxidation state in water, aqueous cadmium is not strongly influenced by the oxidizing or reducing potential of the water. However, under reducing conditions, cadmium may form cadmium sulfide, which is poorly soluble and tends to precipitate. Free (ionic) cadmium seems to be the toxic form and becomes much more prevalent at low salinity. Cadmium has a relatively long residence time in aquatic systems. In Lake Michigan, a mean residence time of 4-10 years was calculated for cadmium compared to 22 years calculated for mercury.

Precipitation and sorption to mineral surfaces, hydrous metal oxides, and organic materials are the most important processes for removal of cadmium to bed sediments. Humic acid is the major component of sediment responsible for adsorption. Sorption increases as the pH increases.

Sediment bacteria may also assist in the partitioning of cadmium from water to sediments. Both cadmium-sensitive and cadmium-resistant bacteria reduced the cadmium concentration in the water column from 1 ppm to between 0.2 and 0.6 ppm, with a corresponding increase in cadmium concentration in the sediments in the simulated environment. Studies indicate that concentrations of cadmium in sediments are at least one order of magnitude higher than in the overlying water. The mode of sorption of cadmium to sediments is important in determining its disposition to remobilize. Cadmium associated with carbonate minerals, precipitated as stable solid compounds or co-precipitated with hydrous iron oxides, is less likely to be mobilized by resuspension of sediments or biological activity. Cadmium that is adsorbed to mineral surfaces such as clay, or to organic materials, is more easily bioaccumulated or released in the dissolved state when the sediment is disturbed. Cadmium may redissolve from sediments under varying ambient conditions of pH, salinity, and redox potential. Cadmium is not known to form volatile compounds in the aquatic environment, so partitioning from water to the atmosphere does not occur.

In soils, pH, oxidation-reduction reactions, and formation of complexes are important factors affecting the mobility of cadmium. Cadmium can participate in exchange reactions on the negatively charged surface of clay minerals. In acid soils, the reaction is reversible. However, adsorption increases with pH and may become irreversible. Cadmium also may precipitate as insoluble cadmium compounds, or form complexes or chelates by interaction with organic matter. Available data suggest that organic matter is more effective than inorganic constituents in keeping cadmium unavailable. Examples of cadmium compounds found in soil are Cd<sub>3</sub>(PO<sub>4</sub>)<sub>2</sub>, CdCO<sub>3</sub>, and Cd(OH)<sub>2</sub>. These compounds are formed as the pH rises. It has been found that about 90% of cadmium in soils remains in the top 15 cm.

Aquatic and terrestrial organisms bioaccumulate cadmium. Cadmium concentrates in freshwater and marine animals to concentrations hundreds to thousands of times higher than in the water. Reported bioconcentration factors (BCFs) range from 113 to 18,000 for invertebrates, from 3 to 4,190 for fresh water aquatic organisms, and from 5 to 3,160 for saltwater aquatic organisms. Bioconcentration in fish depends on the pH and the humus

continued...

# SANYO NICKEL CADMIUM BATTERY, RECHARGEABLE

Chemwatch Material Safety Data Sheet

Issue Date: 21-Jul-2008

NC317ECP

CHEMWATCH 7134-83

Version No:2.0

CD 2008/2 Page 17 of 21

Section 12 - ECOLOGICAL INFORMATION

cadmium with a resultant protective action against its toxic effects.

Significant compartments for soluble cadmium salts are likely to be soil and water.

Cadmium(II) adsorbs to sediments. Once in an aquatic environment cadmium is highly mobile; its dissolved species are highly labile and are first to be released, for example, when salinity is increased in estuaries. In fresh water, cadmium toxicity is influenced by water hardness (the harder the water, the lower the toxicity). Cadmium can bioaccumulate and bioconcentrate in the food chain. Biomagnification in terrestrial food chains is not expected.

Cadmium is more mobile in aquatic environments than most other heavy metals (e.g., lead). In most natural surface waters, the affinities of complexing ligands for cadmium generally follow the order of humic acids > CO<sub>3</sub><sup>2-</sup> > OH<sup>-</sup> > Cl<sup>-</sup> > SO<sub>4</sub><sup>2-</sup>. In unpolluted natural waters, most cadmium transported in the water column will exist in the dissolved state as the hydrated ion Cd(H<sub>2</sub>O)<sub>6</sub><sup>2+</sup>. Minor amounts of cadmium are transported with the coarse particulates, and only a small fraction is transported with the colloids. In unpolluted waters, cadmium can be removed from solution by exchange of cadmium for calcium in the lattice structure of carbonate minerals. In polluted organic-rich waters, adsorption of cadmium by humic substances and other organic complexing agents plays a dominant role in transport, partitioning, and remobilization of cadmium. Cadmium concentration in water is inversely related to the pH and the concentration of organic material in the water. Because cadmium exists only in the +2 oxidation state in water, aqueous cadmium is not strongly influenced by the oxidizing or reducing potential of the water. However, under reducing conditions, cadmium may form cadmium sulfide, which is poorly soluble and tends to precipitate. Free (ionic) cadmium seems to be the toxic form and becomes much more prevalent at low salinity. Cadmium has a relatively long residence time in aquatic systems. In Lake Michigan, a mean residence time of 4-10 years was calculated for cadmium compared to 22 years calculated for mercury.

Precipitation and sorption to mineral surfaces, hydrous metal oxides, and organic materials are the most important processes for removal of cadmium to bed sediments. Humic acid is the major component of sediment responsible for adsorption. Sorption increases as the pH increases.

Sediment bacteria may also assist in the partitioning of cadmium from water to sediments. Both cadmium-sensitive and cadmium-resistant bacteria reduced the cadmium concentration in the water column from 1 ppm to between 0.2 and 0.6 ppm, with a corresponding increase in cadmium concentration in the sediments in the simulated environment. Studies indicate that concentrations of cadmium in sediments are at least one order of magnitude higher than in the overlying water. The mode of sorption of cadmium to sediments is important in determining its disposition to remobilize. Cadmium associated with carbonate minerals, precipitated as stable solid compounds or co-precipitated with hydrous iron oxides, is less likely to be mobilized by resuspension of sediments or biological activity. Cadmium that is adsorbed to mineral surfaces such as clay, or to organic materials, is more easily bioaccumulated or released in the dissolved state when the sediment is disturbed. Cadmium may redissolve from sediments under varying ambient conditions of pH, salinity, and redox potential. Cadmium is not known to form volatile compounds in the aquatic environment, so partitioning from water to the atmosphere does not occur.

In soils, pH, oxidation-reduction reactions, and formation of complexes are important factors affecting the mobility of cadmium. Cadmium can participate in exchange reactions on the negatively charged surface of clay minerals. In acid soils, the reaction is reversible. However, adsorption increases with pH and may become irreversible. Cadmium also may precipitate as insoluble cadmium compounds, or form complexes or chelates by interaction with organic matter. Available data suggest that organic matter is more effective than inorganic constituents in keeping cadmium unavailable. Examples of cadmium compounds found in soil are Cd<sub>3</sub>(PO<sub>4</sub>)<sub>2</sub>, CdCO<sub>3</sub>, and Cd(OH)<sub>2</sub>. These compounds are formed as the pH rises. It has been found that about 90% of cadmium in soils remains in the top 15 cm.

Aquatic and terrestrial organisms bioaccumulate cadmium. Cadmium concentrates in freshwater and marine animals to concentrations hundreds to thousands of times higher than in the water. Reported bioconcentration factors (BCFs) range from 113 to 18,000 for invertebrates, from 3 to 4,190 for fresh water aquatic organisms, and from 5 to 3,160 for saltwater aquatic organisms. Bioconcentration in fish depends on the pH and the humus

continued...

# SANYO NICKEL CADMIUM BATTERY, RECHARGEABLE

Chemwatch Material Safety Data Sheet  
Issue Date: 21-Jul-2008  
NC317ECP

CHEMWATCH 7134-83  
Version No:2.0  
CD 2008/2 Page 19 of 21  
Section 12 - ECOLOGICAL INFORMATION

compartments, is strongly influenced by particle size. Fine particulate matter has a longer residence time in the environment and is carried a long distance from its source; larger particles are deposited near the emission source. Atmospheric residence time for nickel particulates is estimated to be 5.4-7.9 days. Water solubility and bioavailability is affected by soil pH; decrease in pH generally mobilises nickel, thus acid rain can mobilise nickel from the soil and increase nickel concentrations in ground water. Nickel bioaccumulates in the food chain but is not bioconcentrated.

Drinking Water Standards:

Nickel 50 ug/l (UK max.)

20 ug/l (WHO guideline)

Soil Guidelines:

Dutch Criteria: 35 mg/kg (target)

210 mg/kg (intervention).

DO NOT discharge into sewer or waterways.

**POTASSIUM HYDROXIDE:**

Prevent, by any means available, spillage from entering drains or water courses.

DO NOT discharge into sewer or waterways.

## Section 13 - DISPOSAL CONSIDERATIONS

- Recycle wherever possible or consult manufacturer for recycling options.
- Consult State Land Waste Management Authority for disposal.
- Bury residue in an authorised landfill.
- Recycle containers if possible, or dispose of in an authorised landfill.

## Section 14 - TRANSPORTATION INFORMATION

HAZCHEM: None

NOT REGULATED FOR TRANSPORT OF DANGEROUS GOODS:UN, IATA, IMDG

## Section 15 - REGULATORY INFORMATION

**POISONS SCHEDULE: None**

### REGULATIONS

Sanyo Nickel Cadmium Battery, Rechargeable (CAS: None);  
No regulations applicable

cadmium (CAS: 7440-43-9) is found on the following regulatory lists;

Australia - Australian Capital Territory - Environment Protection Regulation: Ambient environmental standards (AQUA/1 to 6 - inorganic chemicals)  
Australia - Australian Capital Territory - Environment Protection Regulation: Ambient environmental standards (Domestic water supply - inorganic chemicals)  
Australia - Australian Capital Territory - Environment Protection Regulation: Ambient environmental standards (IRRIG - Inorganic chemicals)  
Australia - Australian Capital Territory - Environment Protection Regulation: Ambient environmental standards (STOCK - inorganic chemicals)  
Australia - Australian Capital Territory - Environment Protection Regulation: Pollutants entering waterways taken to cause environmental harm (Aquatic habitat)  
Australia - Australian Capital Territory - Environment Protection Regulation: Pollutants entering waterways taken to cause environmental harm (IRRIG)  
Australia - Australian Capital Territory - Environment Protection Regulation: Pollutants entering waterways - Agricultural uses (Stock)  
Australia - Australian Capital Territory - Environment Protection Regulation: Pollutants entering waterways - Domestic water quality  
Australia - New South Wales Hazardous Substances Requiring Health Surveillance  
Australia - Tasmania Hazardous Substances Requiring Health Surveillance  
Australia - Western Australia Hazardous Substances Prohibited for Specified Uses or Methods of Handling  
Australia - Western Australia Hazardous Substances Requiring Health Surveillance  
Australia Exposure Standards  
Australia Hazardous Substances  
Australia Hazardous Substances Requiring Health Surveillance  
Australia National Pollutant Inventory

continued...

# OPERATING MANUAL — Cordless Framing Nailer

**Paslode®**  
**Impulse**

Nail Gun Impulse e Framing. 0671006.

SCANNED

12/10  
**FrameMaster**

Product Code B20540

Manual # 620

For use  
with Paslode  
fuel cell with  
internal metering  
valve only!

(sold separately)

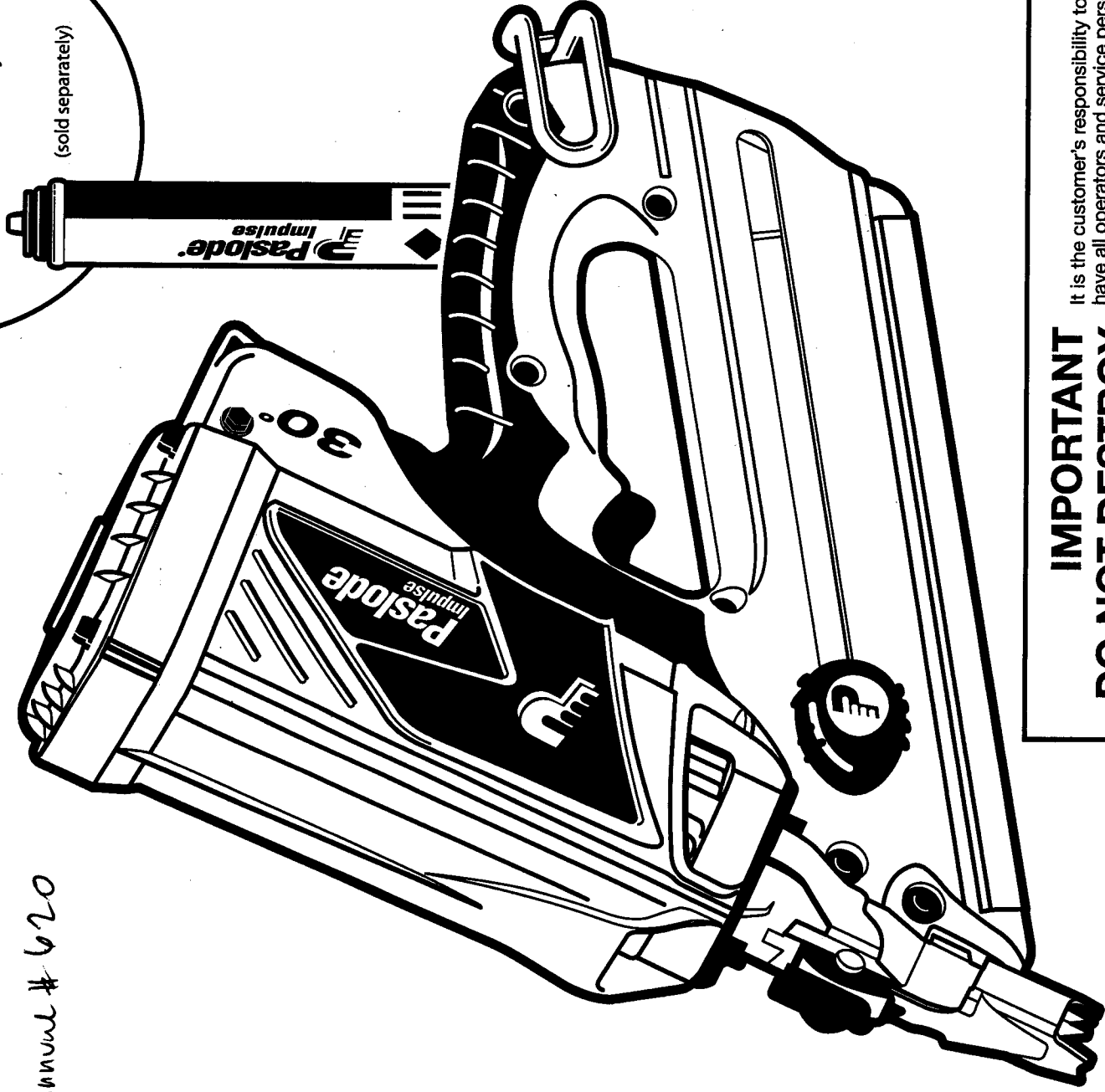

**IMPORTANT**  
**DO NOT DESTROY**

It is the customer's responsibility to  
have all operators and service personnel  
read and understand this manual.

Printed in U.S.A. ©2010 Illinois Tool Works, Inc.

# Paslode® Impulse

## Impulse Tool System Operation

### General safety instructions for internal combustion fastener driving tools

Congratulations on having chosen a Paslode product. Your tool will operate to your full satisfaction for a long time if handled correctly. Use Paslode specified fasteners, fuel cell, rechargeable battery, and spare parts only.

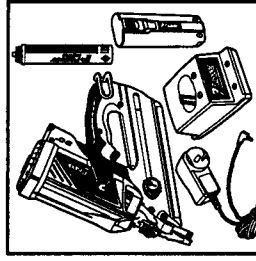
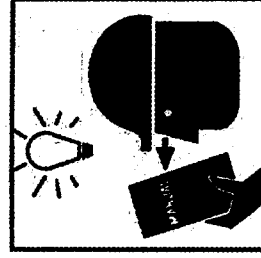
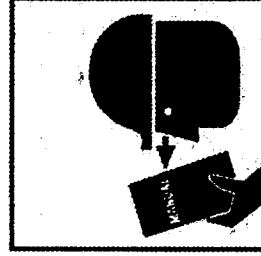
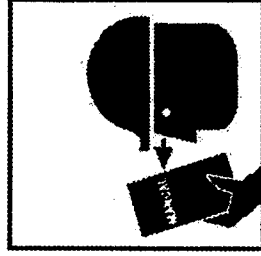
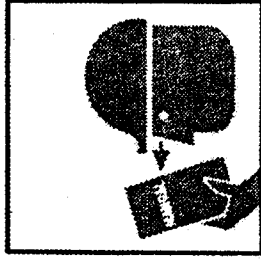

**IMPULSE SYSTEM**  
The IMPULSE SYSTEM consists of tool, fasteners, fuel cell, battery, and battery charger. Only Paslode-specified fasteners, fuel cell, battery and battery charger may be used. The specified units must be seen as a single system in terms of technical safety.

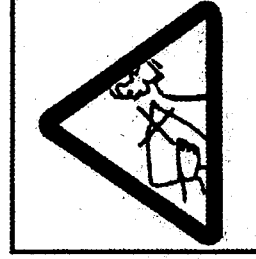

#### FASTENER TOOLS

Never carry tool with trigger depressed. Do not point the work contacting element at your own body or at somebody else. After having work completed, take fuel cell and battery out of tool. Keep tool and parts away from children and unauthorized persons. Store tool, battery, and fuel cell in tool case when not using it for some time.

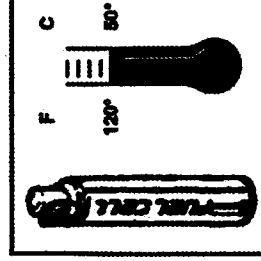

**IMPULSE FUEL CELL**  
The fuel cell is an Aerosol product, the contents are flammable. The container is under pressure. Protect from exposure to temperatures above 50°C (120°F) (i.e. sunlight)! Do not spray against open flames or hot surfaces. Use outside or in well-ventilated areas. Do not burn, attempt to open, or puncture after use. Dispose of according to local regulations for Aerosol products.

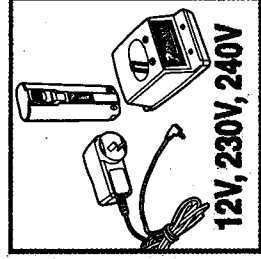

#### IMPULSE BATTERY-BATTERY CHARGER

Use only Paslode IMPULSE 6V battery and IMPULSE battery charger. Check for correct electric voltage. Observe data on battery charger. Store indoors at temperatures below 50°C or above 40°C. Do not open battery and do not throw into fire. Do not dispose of with garbage. Observe local regulations for disposal.

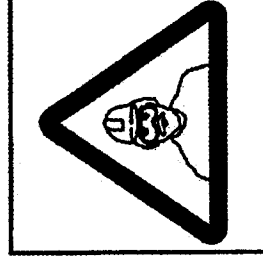

#### EYE PROTECTION

When operating the tool always wear approved eye protection. Small fragments might be shot from work piece. Eye protection is also recommended for persons close to work place.

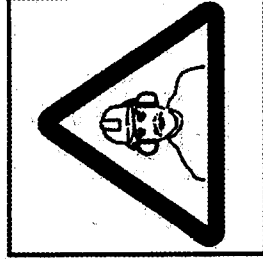

#### HEARING PROTECTION

Wear hearing protection when operating the tool. This reduces the sound level at your ear considerably. Hearing protection is also recommended for persons close to the work place.

# Safety Instructions/Information

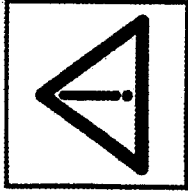

Observe all safety instructions! To avoid injuries to yourself or another person observe also the specific operating manual and service instructions for your tool.



For technical data, sound- and vibration values, information about fuel cell, battery and recharger, specified consumables please see your operating manual and ITW Paslode technical data sheet.



Only use fasteners, battery, fuel cell, battery charger and spare parts as specified in the tool data sheet. Paslode shall in no event be liable by non observation if the instructions. Fasteners are to be used only with timber-to-timber fixing or materials of similar or lesser density if not otherwise specified.



Do not operate close to flammable materials. Exhaust fumes may get heated up depending on work speed. Observe data about speed of work in tool data sheet.

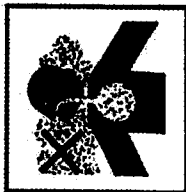

This tool must be operated only in well ventilated environment. Operation of tool causes exhaust fumes of carbon monoxide which are a danger to health when inhaled.

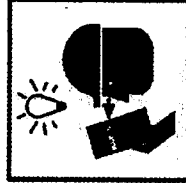

Observe local regulations about storage, handling, and transportation of aerosol products (12 bar/50°C). Storage according to TRG300 (D). International transport regulations are established according to ADR/RID; IATA-DGR; IMDG-Code. No mailing!

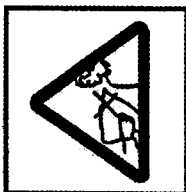

This tool is not a toy. Never assume the tool is empty. Never point the tool at anyone or yourself. Never carry the tool with your finger on the trigger.



Use tool only for the intended application. When tool is ready for operation keep hands away from nosepiece area. Never point nosepiece at yourself or anyone else.



Do not damage housing of tool. No modifications of tool, fuel cell or battery charger are allowed. Do not place tool on oven or radiator, fuel cell in tool might burst. Observe temperature limit of max. 50°C of fuel cell.



Hold the tool in a way to avoid a recoil injuring your head or your body. Beware! When working on stairs, ladders, roofs, or when nailing crates always take a favourable position to the work piece.

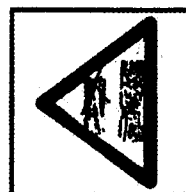

Watch your work piece! Fasteners may fire through the work piece and slide sideways through the work piece thus endangering people. Only operate when holding the tool on the work piece.

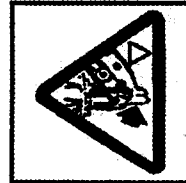

Tools being marked with an upside down equilateral triangle must be used only with a lower probe (work contacting element).



The Impulse nailer should be operated only when it is in contact with the work surface. When fastening thin materials such as plywood, be sure to position the tool so that the fastener is driven into the underlying piece.

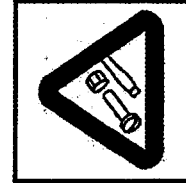

Periodically, check tension of all nuts and bolts on the tools.

Maintenance should only be carried out by competent persons.



Don't smoke when handling fuel cell. Do not inhale its contents. Keep fuel cell valve stem away from face eyes or skin.

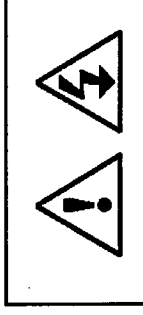

## Safety Instructions for Impulse Battery and Charging System

### IMPORTANT SAFETY INSTRUCTIONS

- 1) Before using battery charging system, read all instructions and cautionary markings on AC-DC Adapter, Charger Base, and Battery.
- 2) Charging system is designed for indoor use only. Do not expose charging system to rain or excessive moisture.
- 3) Make sure cord is located so it will not be stepped on, tripped over, or otherwise subjected to damage or stress.
- 4) Do not operate charging system with damaged cord or plug - replace adapter immediately.
- 5) To reduce the risk of personal injury unplug the the charging system from the outlet before cleaning the contacts. Clean contacts with a dry brush or equivalent only.
- 6) The charging system and battery are specifically designed to work together. Do not attempt to charge any other cordless tool or battery with this charger.
- 7) Do not attempt to charge Impulse battery with any other charging system, other than the Impulse charging system.
- 8) Do not short a battery. A shorted battery can produce high current which can lead to overheating and burns.
- 9) Do not recharge batteries at a temperature below 40°F (5°C) or above 104°F (40°C).
- 10) Do not allow metal objects to come into contact with battery terminals.
- 11) Do not puncture or attempt to open battery case or cells.
- 12) Do not store battery where it will be subject to temperatures above 120°F (50°C).
- 13) Do not incinerate battery.
- 14) Do not use a defective battery charger, one that overheats and/or smokes when plugged in.
- 15) Battery must be recycled or disposed of properly. Battery contains nickel-cadmium cells.

### Declaration of Conformity



Paslode declares that this Charger System has been designed in compliance with the Regulations and Standards of 73/23/EEC and 89/336/EEC.

Rudolf Golsch

*Rudolf Golsch*

Paslode International

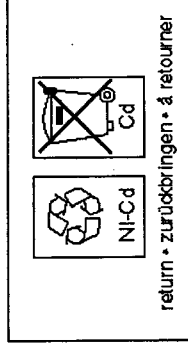

### IMPULSE- Fuel Cell: Transportation /Storage Transportation



#### Labels Required:

Flammable Gas Hazchem: 2WE

UNDG:

Dangerous Goods Class: 2.1

UN Number: 3478

Shipping Name: Fuel Cell Cartridges

#### Storage Requirements:

- Keep out of reach of children.
- Store in original containers in approved flame-proof area.
- DO NOT store in pits, depressions, basements, or areas where vapours may be trapped.
- No smoking, naked lights, heat, or ignition sources.
- Keep containers securely sealed.
- Store away from incompatible materials.
- Store in a cool, dry, well ventilated area in an upright position.
- Avoid storage at temperatures higher than 40°C.
- Protect containers against physical damage and check regularly for leaks.
- Observe manufacturer's storing and handling recommendations.

# Impulse Tool System Operation

## Impulse - Battery/Battery Charger:

The Impulse tool comes with a rechargeable battery and its own charging system. This battery and charging system combination is the only one that will work with Impulse tools.

## CHARGING PROCEDURE:

The battery must be charged before using a new Impulse Tool. New batteries are shipped discharged and must be charged before use. Each charging of the battery will take 5 minutes to 2 hours, depending on amount of discharge.

## NOTE: OPERATING MANUAL FOR 2 HOUR CHARGING SYSTEM (ORANGE)!

### IMPORTANT CHARGING NOTES

	<p><b>ATTENTION!</b></p> <p><b>CHEMICAL/EXPLOSION HAZARD</b></p> <p>Read all instructions before charging or using battery. Disregard of instructions may result in fire, burns</p>
---	---

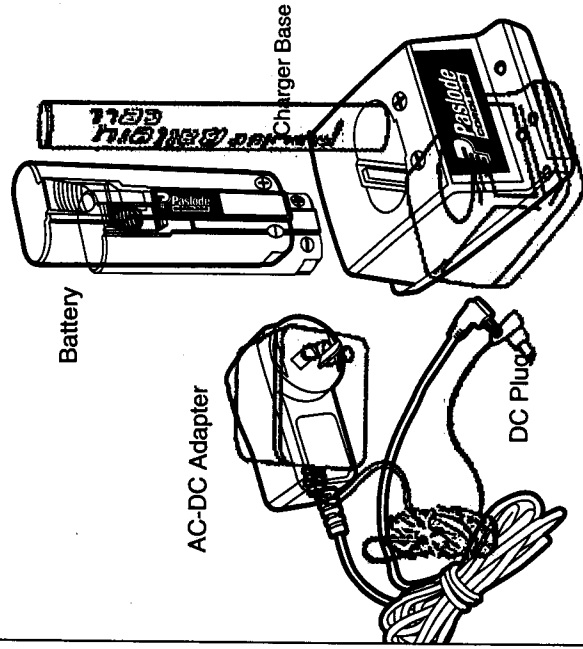

### IMPULSE BATTERY CHARGING SYSTEM

#### REAR VIEW OF CHARGER BASE

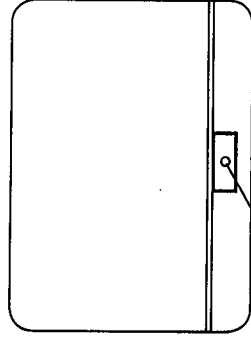

Plug Receptacle

### TECHNICAL DATA

**Impulse Adapter(AC-DC)**  
Australia/New Zealand

**Impulse Charger Base**  
**Impulse Battery**  
6VDC, 1300mAh, Nickel-cadmium

Input	Output	Polarity
240V, 50HZ	12VDC, 800mA	
12VDC, 9.6VA	6VDC, 4.5VA	

### CHARGING INSTRUCTIONS:

1. Place the round DC plug of the adapter into the plug receptacle on the back of the orange charger base. Insert the adapter into the electric current outlet as specified in table below. A green light indicates power is on and charger is ready to use.
2. Insert battery with terminals down into charger base. Charge one battery only at a time.  
**Red light indicates that battery is charging.**  
The green light will turn off.

#### Please Note!

If battery is completely discharged, the red and green lights may flash back and forth for up to 20 minutes. This safety feature slowly recharges the battery until it is ready to accept the full charging current. If the lights continue to flash after 20 minutes, replace the battery.

3. **After charging, the red light will turn off and the green light will come on, indicating that the battery is fully charged.**  
The battery is ready for use!
4. After charging is completed unplug DC plug adapter.

### CHARGING TIMES FOR BATTERY:

- First Charge 2 Hours
- Partially Charged Battery - 5 Min. to 2 Hours
- Completely Discharged Battery 2 Hours

# Impulse Tool System Operation

## The tool consists of three main assemblies:

### Housing with:

Combustion Chamber, Nosepiece, Work Contacting Element, Piston and Driver.

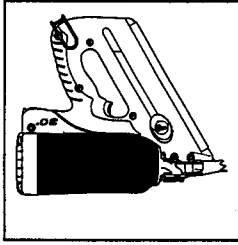

### Handle with:

Tool Electronics, Motor, Spark Plug, Trigger and Compartment for fuel cell.

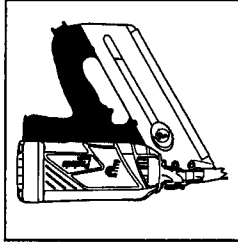

### Magazine for:

Consumables with follower and compartment for Battery.

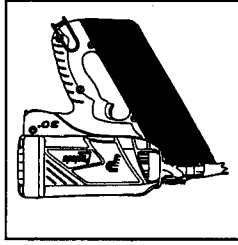

### Fuel Cell:

Consisting of container for fuel (1), FrameMaster Adaptor (2)

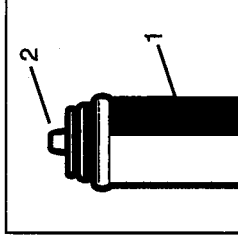

### Battery/Battery

#### Charger:

The battery supplies power to the tool electronics, fan, and spark plug.

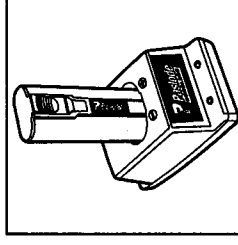

## Impulse - Tool: Operation

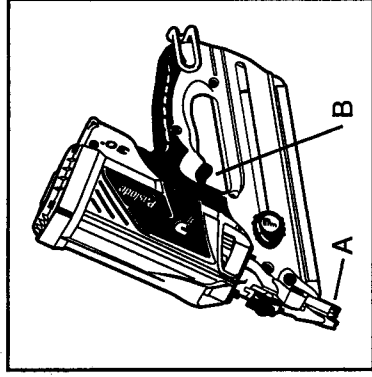

Impulse tools work according to the principles of a linear combustion engine.

Press work contacting element of the tool (A) against work piece.

Combustion chamber is closed and fuel injected.

Fan mixes air and fuel.

Fuel/air mixture ignites by pulling trigger (B).

Combustion drives piston with driver.

Piston and driver return to initial position.

Lift tool from work piece and release trigger (B).

Combustion chamber opens and releases exhaust fumes.

Fan cools tool.

Impulse tool is ready for next single cycle.

## Impulse - Fuel Cell: How to Determine if Fuel Cell Still Has Fuel

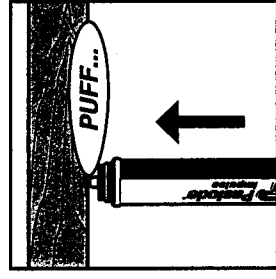

Holding fuel cell with tip pointing **UP** depress tip straight (to avoid damage to fuel cell stem) inward to see if fuel is dispensed (smell of fuel should be noticed). If gas is not dispensed, fuel cell is empty - replace it.

**Observe Safety Regulations.**

**Safety Regulations:** The propellant will remain in the fuel cell. Fuel cell is always under pressure. Propellant and fuel are flammable. Expanding gases cause low temperatures. Caution, fluid gases might cause injuries when getting in touch with skin or eyes. The fuel cell is to be used as stated in the "Fuel Cell" section. Refill forbidden!

# Impulse Tool System Operation

## 1. Before using the tool

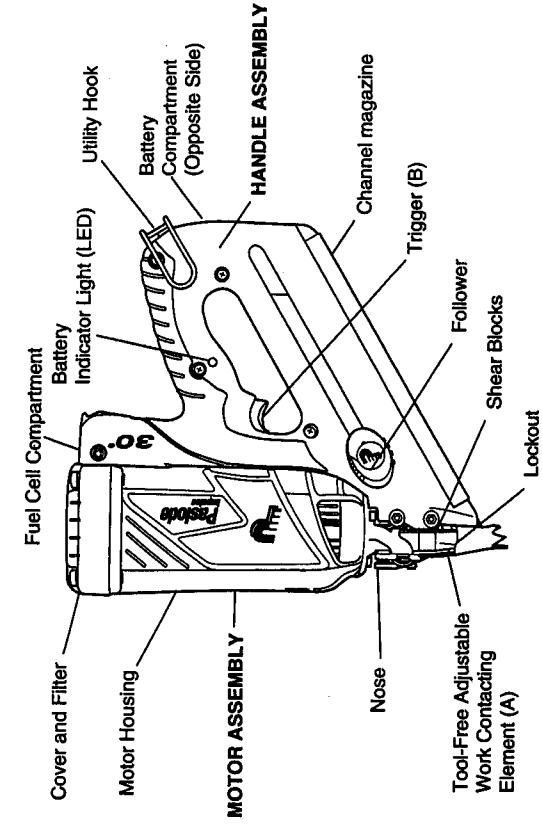

Read safety and operating manuals. Only use the tool when all instructions are understood.

Check work contact element (A) for smooth operation.

Use only for timber to timber fixings or material of similar or lesser density.

Attention: This tool must not be used in a combustible environment.

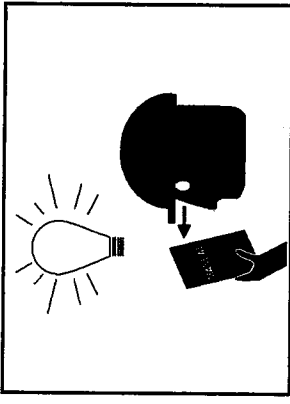

## 2. Battery Loading

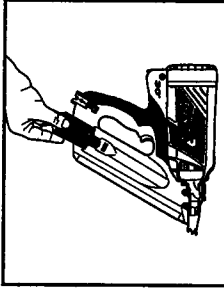

Load impulse battery cell with contacts facing downwards into the battery compartment. Press firmly until battery locking clip is engaged. To remove battery, press the locking clip on the battery and slide battery out of its compartment.

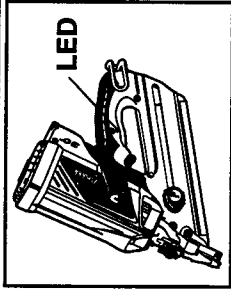

Check LED in Handle of Tool:

LED strobe light green > Battery in tool. (Does not indicate state of charge)

LED strobe light red > Battery is empty, recharge battery!

When work contact element (A) is depressed against workpiece:

LED solid green > Battery charge ready for use.

LED solid red > Battery empty. Recharge!

To recharge battery read charging instructions.

Battery contacts must be clean and free from corrosion; if necessary clean with fine emery cloth.

## 3. Loading Fuel Cartridge

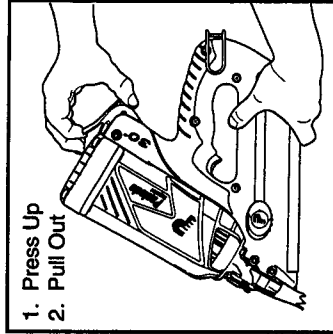

A. Press up at the bottom of the fuel door and pivot outward to open. The door will swing out of the way.

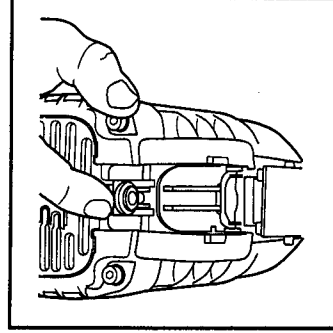

B. Lift the fuel cartridge adaptor and insert the fuel cartridge into the tool.

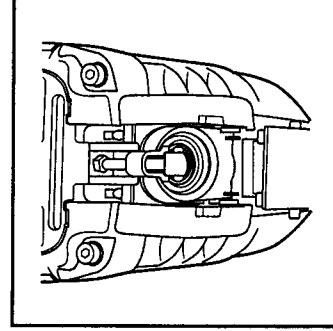

C. Release the adaptor so it is centered on the fuel cartridge.

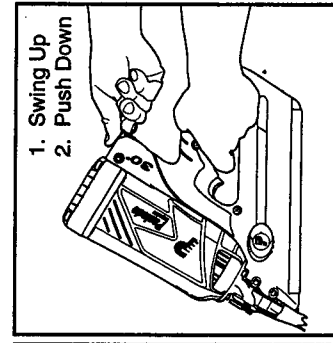

D. Close the fuel door by swinging it up and over the fuel cartridge, and pushing down until the fuel door snaps into position.

# Impulse Tool System Operation

## 4. Fastener Loading, Reloading and Removal

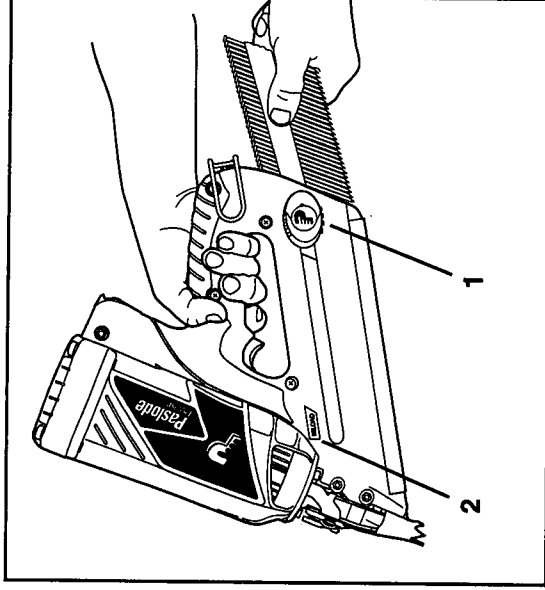

To load Fasteners:

1. Pull back the follower (1) until it reaches the locked position at the end of the magazine.
  2. Insert Paslode fasteners selected from technical specification sheet into the slot at the rear of the magazine. The fasteners will slide freely into the tool.
  3. Release the follower lock by depressing centre button on the follower and gently allow the follower to push the fastener strip forward to the correct firing position. Do not allow the follower to spring forward against the fastener strip otherwise collation may be damaged.
  4. Reload tool when centre button has reached "reload" arrow (2) or lock-out mechanism is activated.
  5. To unload fasteners again pull back follower to the locked position and simply slide out fasteners.
- Note: 1) Do not depress trigger when loading or unloading fasteners.  
2) The lockout mechanism is activated when approx. 5 nails remain in magazine.

To remove these refer to point 5 above.

**With fasteners, Battery and Fuel Cells loaded the Tool is now ready for use.**

## 5. Trigger System

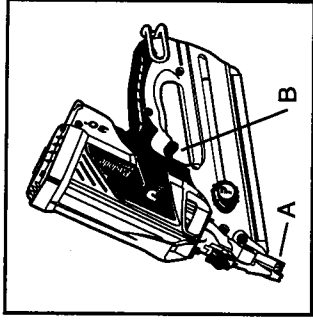

The Impulse nailer is equipped with a full sequential actuation (trigger) system for safety. For each operation the work contacting element (A) and trigger (B) must be actuated. For operation press work contacting element (A) on workpiece and squeeze trigger (B) for release of nail. Thereafter any further driving operations can only be actuated if the trigger (B) and work contacting element (A) have been returned to the starting position.

## 6. Cycle Rate

Intermittent Operation - 2 to 3 nails per second

Continuous Operation - 1000 nails per hour

**NOTE:** Exceeding these rates could cause tool to overheat, resulting in loss of performance or damage to tool components. By using the Impulse FrameMaster Nailer at its recommended cycle rate, you will be able to drive several thousand nails in a typical workday.

## 7. Tool Operation

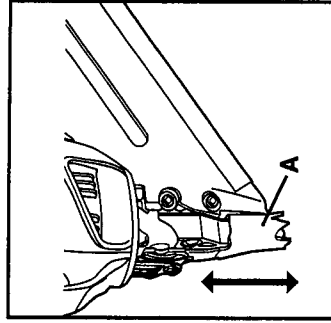

1. Taking a firm grip of the tool handle fully depress the work contact element (A) against the work surface. This will close the combustion chamber, inject fuel and the fan will mix air and fuel.
2. Squeeze the trigger (B). The injected fuel in the combustion chamber is ignited and the combustion drives the piston assembly which in turn drives the fastener.
3. Release trigger and lift tool. Combustion chamber opens, fan cools tool internals. N.B. Fan will run for approximately 10 seconds after nailing is completed.
4. Tool is ready for the next cycle. **NOTE:** the tool is equipped with a lock-out mechanism operating when only 4-5 nails are left in magazine.

# OPERATING MANUAL — Cordless Framing Nailer

**Paslode**  
Impulse

Nail Gun Impulse Framing. 0671006.

SCANNED

12/10  
FrameMaster

Product Code B20540

Manual #

For use  
with Paslode  
fuel cell with  
internal metering  
valve only!

(sold separately)

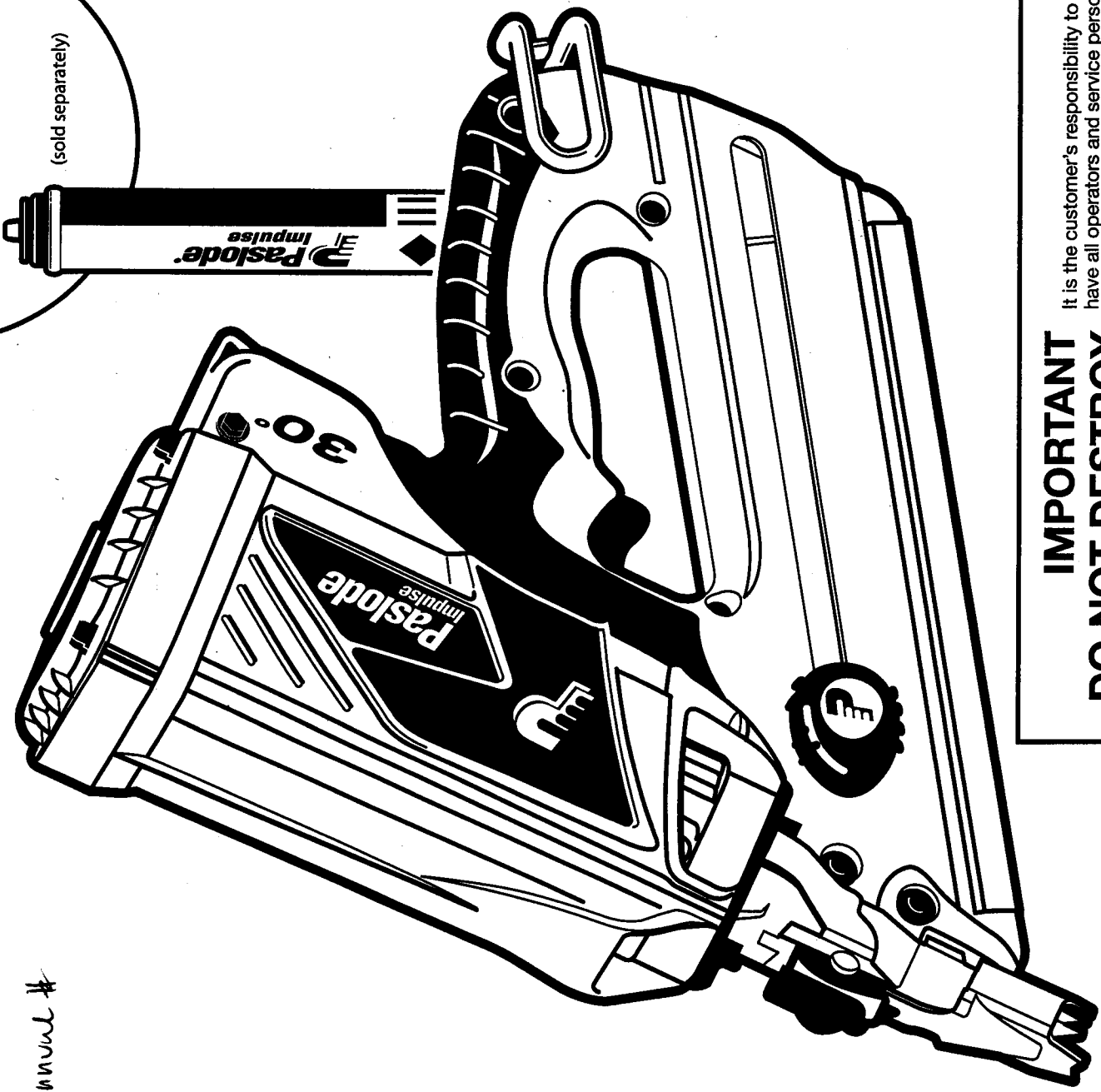

**IMPORTANT**  
**DO NOT DESTROY**

It is the customer's responsibility to have all operators and service personnel read and understand this manual.

Printed in U.S.A. ©2010 Illinois Tool Works, Inc.

# Paslode® Impulse

## Impulse Tool System Operation

### General safety instructions for internal combustion fastener driving tools

Congratulations on having chosen a Paslode product. Your tool will operate to your full satisfaction for a long time if handled correctly. Use Paslode specified fasteners, fuel cell, rechargeable battery, and spare parts only.

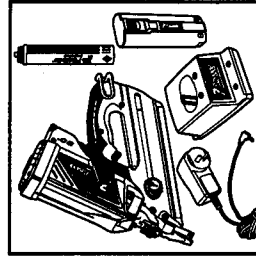
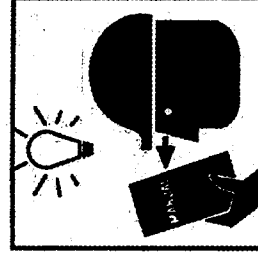
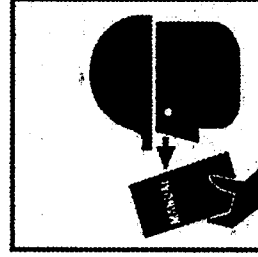
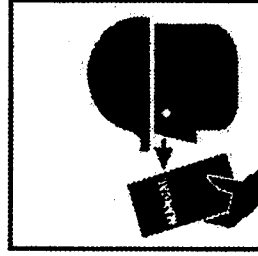
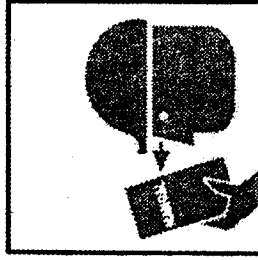

#### IMPULSE SYSTEM

The IMPULSE SYSTEM consists of tool, fasteners, fuel cell, battery, and battery charger. Only Paslode-specified fasteners, fuel cell, battery and battery charger may be used. The specified units must be seen as a single system in terms of technical safety.

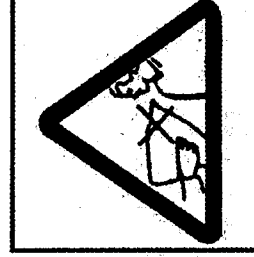

#### FASTENER TOOLS

Never carry tool with trigger depressed. Do not point the work contacting element at your own body or at somebody else. After having work completed, take fuel cell and battery out of tool. Keep tool and parts away from children and unauthorized persons. Store tool, battery, and fuel cell in tool case when not using it for some time.

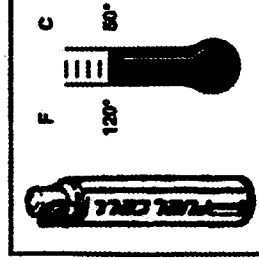

#### IMPULSE FUEL CELL

The fuel cell is an Aerosol product, the contents are flammable. The container is under pressure. Protect from exposure to temperatures above 50°C (120°F) (i.e. sunlight)! Do not spray against open flames or hot surfaces. Use outside or in well-ventilated areas. Do not burn, attempt to open, or puncture after use. Dispose of according to local regulations for Aerosol products.

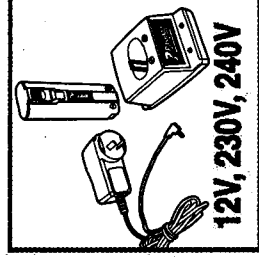

#### IMPULSE BATTERY-BATTERY CHARGER

Use only Paslode IMPULSE 6V battery and IMPULSE battery charger. Check for correct electric voltage. Observe data on battery charger. Store indoors at temperatures below 50°C or above 40°C. Do not open battery and do not throw into fire. Do not dispose of with garbage. Observe local regulations for disposal.

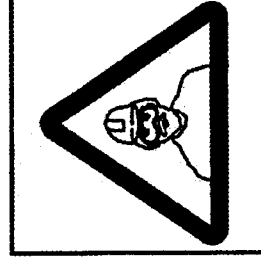

#### EYE PROTECTION

When operating the tool always wear approved eye protection. Small fragments might be shot from work piece. Eye protection is also recommended for persons close to work place.

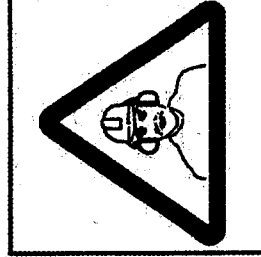

#### HEARING PROTECTION

Wear hearing protection when operating the tool. This reduces the sound level at your ear considerably. Hearing protection is also recommended for persons close to the work place.

# Safety Instructions/Information

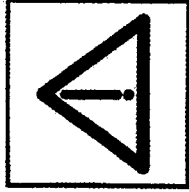

Observe all safety instructions! To avoid injuries to yourself or another person observe also the specific operating manual and service instructions for your tool.

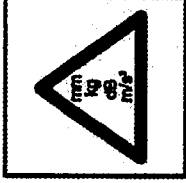

For technical data, sound- and vibration values, information about fuel cell, battery and recharger, specified consumables please see your operating manual and ITW Paslode technical data sheet.



Only use fasteners, battery, fuel cell, battery charger and spare parts as specified in the tool data sheet. Paslode shall in no event be liable by non observation if the instructions. Fasteners are to be used only with timber-to-timber fixing or materials of similar or lesser density if not otherwise specified.



Do not operate close to flammable materials. Exhaust fumes may get heated up depending on work speed. Observe data about speed of work in tool data sheet.



This tool must be operated only in well ventilated environment. Operation of tool causes exhaust fumes of carbon monoxide which are a danger to health when inhaled.



Observe local regulations about storage, handling, and transportation of aerosol products (12 bar/50°C). Storage according to TRG300 (D). International transport regulations are established according to ADR/RID; IATA-DGR; IMDG-Code. No mailing!

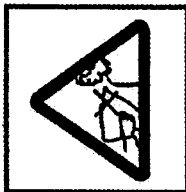

This tool is not a toy. Never assume the tool is empty. Never point the tool at anyone or yourself. Never carry the tool with your finger on the trigger.



Use tool only for the intended application. When tool is ready for operation keep hands away from nosepiece area. Never point nosepiece at yourself or anyone else.



Do not damage housing of tool. No modifications of tool, fuel cell or battery charger are allowed. Do not place tool on oven or radiator, fuel cell in tool might burst. Observe temperature limit of max. 50°C of fuel cell.



Hold the tool in a way to avoid a recoil injuring your head or your body. Beware! When working on stairs, ladders, roofs, or when nailing crates always take a favourable position to the work piece.

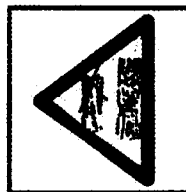

Watch your work place! Fasteners may fire through the work piece and slide sideways through the work piece thus endangering people. Only operate when holding the tool on the work piece.



Tools being marked with an upside down equilateral triangle must be used only with a lower probe (work contacting element).



The Impulse nailer should be operated only when it is in contact with the work surface. When fastening thin materials such as plywood, be sure to position the tool so that the fastener is driven into the underlying piece.

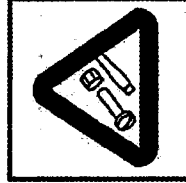

Periodically, check tension of all nuts and bolts on the tools.

Maintenance should only be carried out by competent persons.



Don't smoke when handling fuel cell. Do not inhale its contents. Keep fuel cell valve stem away from face eyes or skin.

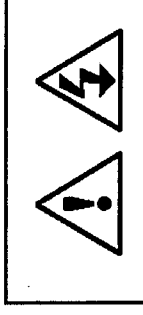

## Safety Instructions for Impulse Battery and Charging System

### IMPORTANT SAFETY INSTRUCTIONS

- 1) Before using battery charging system, read all instructions and cautionary markings on AC-DC Adapter, Charger Base, and Battery.
- 2) Charging system is designed for indoor use only. Do not expose charging system to rain or excessive moisture.
- 3) Make sure cord is located so it will not be stepped on, tripped over, or otherwise subjected to damage or stress.
- 4) Do not operate charging system with damaged cord or plug - replace adapter immediately.
- 5) To reduce the risk of personal injury unplug the the charging system from the outlet before cleaning the contacts. Clean contacts with a dry brush or equivalent only.
- 6) The charging system and battery are specifically designed to work together. Do not attempt to charge any other cordless tool or battery with this charger.
- 7) Do not attempt to charge Impulse battery with any other charging system, other than the Impulse charging system.
- 8) Do not short a battery. A shorted battery can produce high current which can lead to overheating and burns.
- 9) Do not recharge batteries at a temperature below 40°F (5°C) or above 104°F (40°C).
- 10) Do not allow metal objects to come into contact with battery terminals.
- 11) Do not puncture or attempt to open battery case or cells.
- 12) Do not store battery where it will be subject to temperatures above 120°F (50°C).
- 13) Do not incinerate battery.
- 14) Do not use a defective battery charger, one that overheats and/or smokes when plugged in.
- 15) Battery must be recycled or disposed of properly. Battery contains nickel-cadmium cells.

### Declaration of Conformity



Paslode declares that this Charger System has been designed in compliance with the Regulations and Standards of 73/23/EEC and 89/336/EEC.

Rudolf Golsch

*Rudolf Golsch*

Paslode International

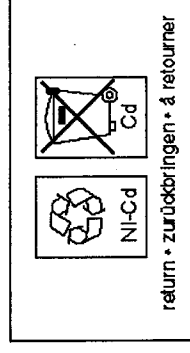

### IMPULSE- Fuel Cell: Transportation /Storage Transportation



#### Labels Required:

Flammable Gas Hazchem: 2WE

UNDG:

Dangerous Goods Class: 2.1

UN Number: 3478

Shipping Name: Fuel Cell Cartridges

#### Storage Requirements:

- Keep out of reach of children.
- Store in original containers in approved flame-proof area.
- DO NOT store in pits, depressions, basements, or areas where vapours may be trapped.
- No smoking, naked lights, heat, or ignition sources.
- Keep containers securely sealed.
- Store away from incompatible materials.
- Store in a cool, dry, well ventilated area in an upright position.
- Avoid storage at temperatures higher than 40°C.
- Protect containers against physical damage and check regularly for leaks.
- Observe manufacturer's storing and handling recommendations.

# Impulse Tool System Operation

## Impulse - Battery/Battery Charger:

The Impulse tool comes with a rechargeable battery and its own charging system. This battery and charging system combination is the only one that will work with Impulse tools.

## CHARGING PROCEDURE:

The battery must be charged before using a new Impulse Tool. New batteries are shipped discharged and must be charged before use. Each charging of the battery will take 5 minutes to 2 hours, depending on amount of discharge.

## NOTE: OPERATING MANUAL FOR 2 HOUR CHARGING SYSTEM (ORANGE)!

### IMPORTANT CHARGING NOTES

	<p><b>ATTENTION!</b></p> <p><b>CHEMICAL/EXPLOSION HAZARD</b></p> <p>Read all instructions before charging or using battery. Disregard of instructions may result in fire, burns</p>
---	---

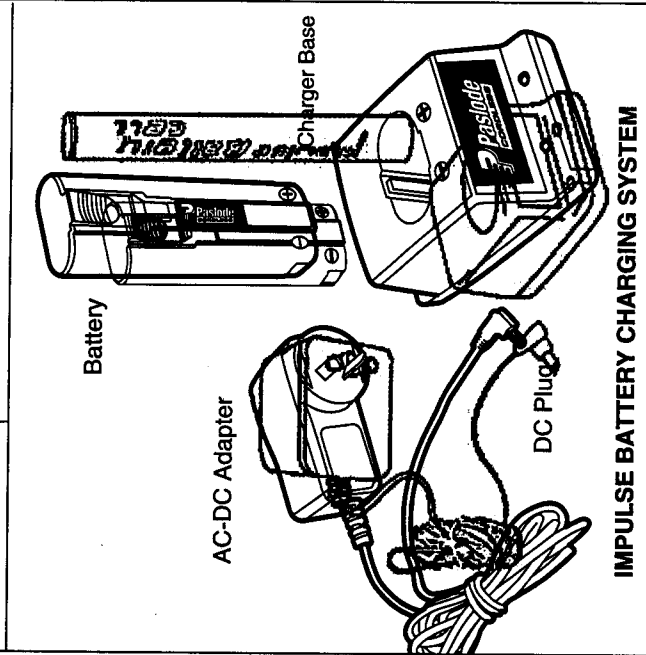

### IMPULSE BATTERY CHARGING SYSTEM

#### REAR VIEW OF CHARGER BASE

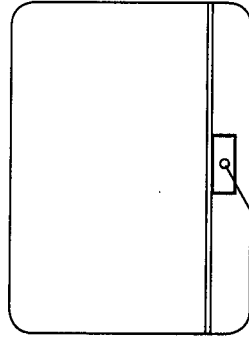

Plug Receptacle

### TECHNICAL DATA

Impulse Adapter(AC-DC)  
Australia/New Zealand

Impulse Charger Base  
Impulse Battery  
6VDC, 1300mAh, Nickel-cadmium

Input	Output	Polarity
240V, 50HZ	12VDC, 800mA	
12VDC, 9.6VA	6VDC, 4.5VA	

### CHARGING INSTRUCTIONS:

1. Place the round DC plug of the adapter into the plug receptacle on the back of the orange charger base. Insert the adapter into the electric current outlet as specified in table below. A green light indicates power is on and charger is ready to use.
2. Insert battery with terminals down into charger base. Charge one battery only at a time.  
**Red light indicates that battery is charging.**  
The green light will turn off.

#### Please Note!

If battery is completely discharged, the red and green lights may flash back and forth for up to 20 minutes. This safety feature slowly recharges the battery until it is ready to accept the full charging current. If the lights continue to flash after 20 minutes, replace the battery.

3. **After charging, the red light will turn off and the green light will come on, indicating that the battery is fully charged.**  
The battery is ready for use!
4. After charging is completed unplug DC plug adapter.

### CHARGING TIMES FOR BATTERY:

- First Charge 2 Hours
- Partially Charged Battery - 5 Min. to 2 Hours
- Completely Discharged Battery 2 Hours

# Impulse Tool System Operation

## The tool consists of three main assemblies:

### Housing with:

Combustion Chamber, Nosepiece, Work Contacting Element, Piston and Driver.

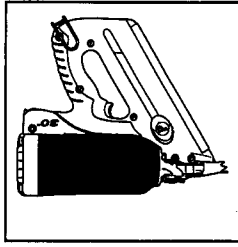

### Handle with:

Tool Electronics, Motor, Spark Plug, Trigger and Compartment for fuel cell.

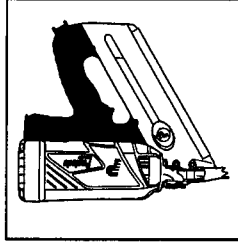

### Magazine for:

Consumables with follower and compartment for Battery.

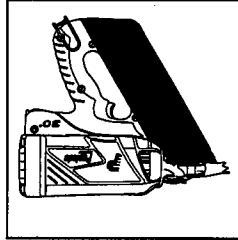

### Fuel Cell:

Consisting of container for fuel (1), FrameMaster Adaptor (2)

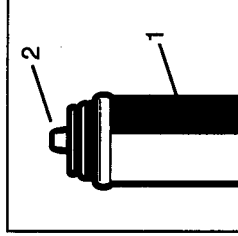

### Battery/Battery Charger:

The battery supplies power to the tool electronics, fan, and spark plug.

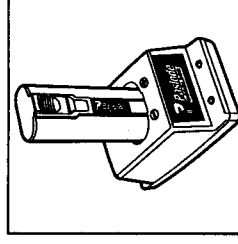

## Impulse - Tool: Operation

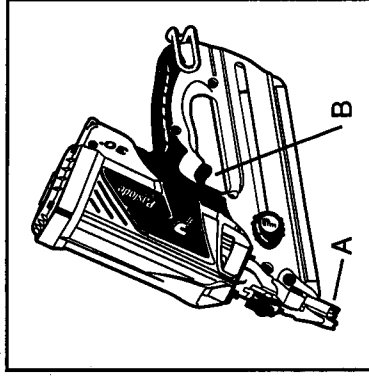

Impulse tools work according to the principles of a linear combustion engine.

Press work contacting element of the tool (A) against work piece.

Combustion chamber is closed and fuel injected.

Fan mixes air and fuel.

Fuel/air mixture ignites by pulling trigger (B).

Combustion drives piston with driver.

Piston and driver return to initial position.

Lift tool from work piece and release trigger (B).

Combustion chamber opens and releases exhaust fumes.

Fan cools tool.

Impulse tool is ready for next single cycle.

## Impulse - Fuel Cell: How to Determine if Fuel Cell Still Has Fuel

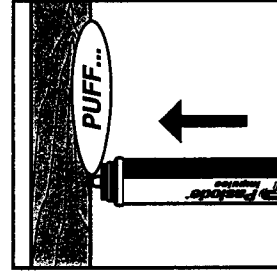

Holding fuel cell with tip pointing **UP** depress tip **straight** (to avoid damage to fuel cell stem) inward to see if fuel is dispensed (smell of fuel should be noticed). If gas is not dispensed, fuel cell is empty - replace it.

**Observe Safety Regulations.**

**Safety Regulations:** The propellant will remain in the fuel cell. Fuel cell is always under pressure. Propellant and fuel are flammable. Expanding gases cause low temperatures. Caution, fluid gases might cause injuries when getting in touch with skin or eyes. The fuel cell is to be used as stated in the "Fuel Cell" section. Refill forbidden!

# Impulse Tool System Operation

## 1. Before using the tool

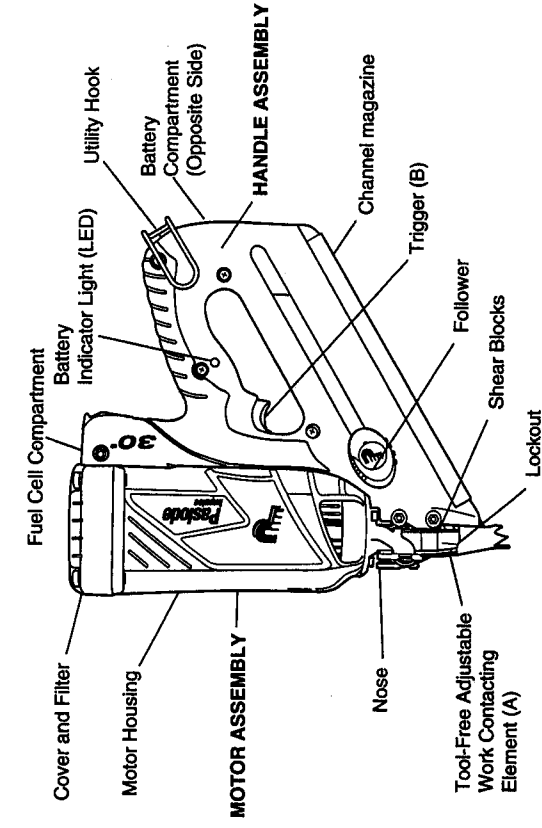

Read safety and operating manuals. Only use the tool when all instructions are understood.

Check work contact element (A) for smooth operation.

Use only for timber to timber fixings or material of similar or lesser density.

Attention: This tool must not be used in a combustible environment.

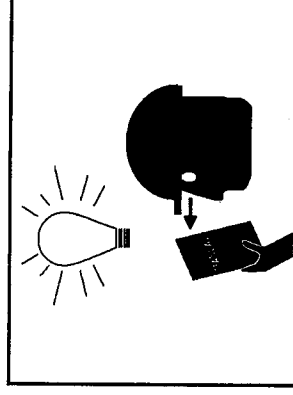

## 2. Battery Loading

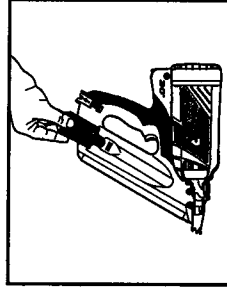

Load impulse battery cell with contacts facing downwards into the battery compartment. Press firmly until battery locking clip is engaged. To remove battery, press the locking clip on the battery and slide battery out of its compartment.

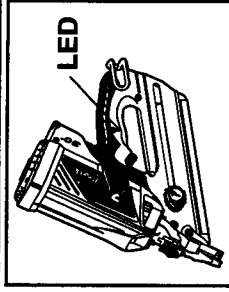

Check LED in Handle of Tool:

LED strobe light green > Battery in tool. (Does not indicate state of charge)

LED strobe light red > Battery is empty, recharge battery!

When work contact element (A) is depressed against workpiece:

LED solid green > Battery charge ready for use.

LED solid red > Battery empty. Recharge!

To recharge battery read charging instructions.

Battery contacts must be clean and free from corrosion; if necessary clean with fine emery cloth.

## 3. Loading Fuel Cartridge

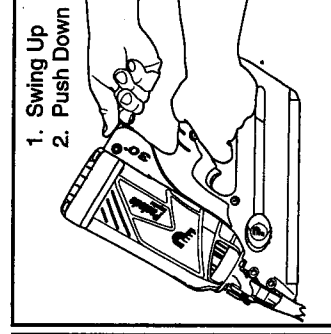
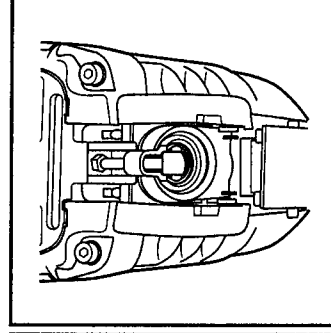
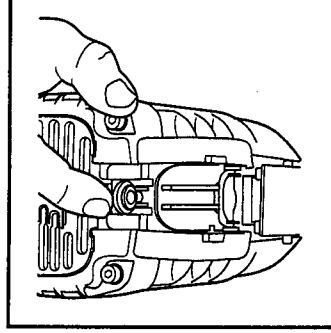
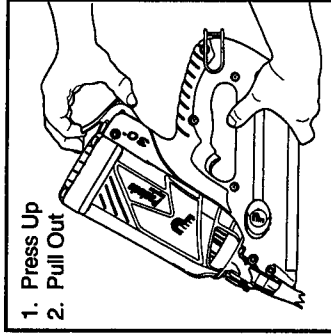

A. Press up at the bottom of the fuel door and pivot outward to open. The door will swing out of the way.

B. Lift the fuel cartridge adaptor and insert the fuel cartridge into the tool.

C. Release the adaptor so it is centered on the fuel cartridge.

D. Close the fuel door by swinging it up and over the fuel cartridge, and pushing down until the fuel door snaps into position.

# Impulse Tool System Operation

## 4. Fastener Loading, Reloading and Removal

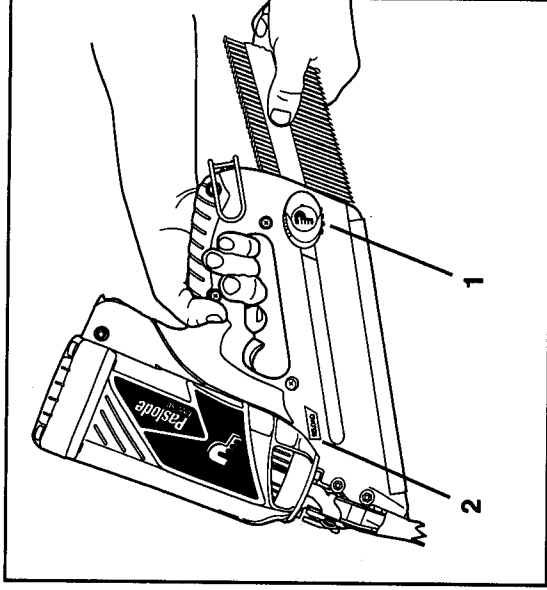

To load Fasteners:

1. Pull back the follower (1) until it reaches the locked position at the end of the magazine.
2. Insert Paslode fasteners selected from technical specification sheet into the slot at the rear of the magazine. The fasteners will slide freely into the tool.
3. Release the follower lock by depressing centre button on the follower and gently allow the follower to push the fastener strip forward to the correct firing position. Do not allow the follower to spring forward against the fastener strip otherwise collation may be damaged.
4. Reload tool when centre button has reached "reload" arrow (2) or lock-out mechanism is activated.
5. To unload fasteners again pull back follower to the locked position and simply slide out fasteners.

Note: 1) Do not depress trigger when loading or unloading fasteners.  
2) The lockout mechanism is activated when approx. 5 nails remain in magazine.

To remove these refer to point 5 above.

**With fasteners, Battery and Fuel Cells loaded the Tool is now ready for use.**

## 5. Trigger System

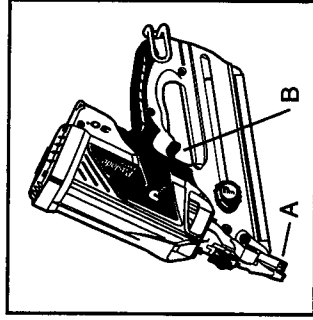

The Impulse nailer is equipped with a full sequential actuation (trigger) system for safety. For each operation the work contacting element (A) and trigger (B) must be actuated. For operation press work contacting element (A) on workpiece and squeeze trigger (B) for release of nail. Thereafter any further driving operations can only be actuated if the trigger (B) and work contacting element (A) have been returned to the starting position.

## 6. Cycle Rate

Intermittent Operation - 2 to 3 nails per second

Continuous Operation - 1000 nails per hour

NOTE: Exceeding these rates could cause tool to overheat, resulting in loss of performance or damage to tool components. By using the Impulse FrameMaster Nailer at its recommended cycle rate, you will be able to drive several thousand nails in a typical workday.

## 7. Tool Operation

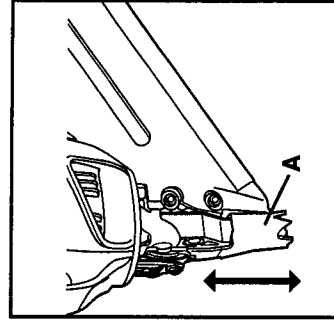

1. Taking a firm grip of the tool handle fully depress the work contact element (A) against the work surface. This will close the combustion chamber, inject fuel and the fan will mix air and fuel.
2. Squeeze the trigger (B). The injected fuel in the combustion chamber is ignited and the combustion drives the piston assembly which in turn drives the fastener.
3. Release trigger and lift tool. Combustion chamber opens, fan cools tool internals. N.B. Fan will run for approximately 10 seconds after nailing is completed.
4. Tool is ready for the next cycle. NOTE: the tool is equipped with a lock-out mechanism operating when only 4-5 nails are left in magazine.

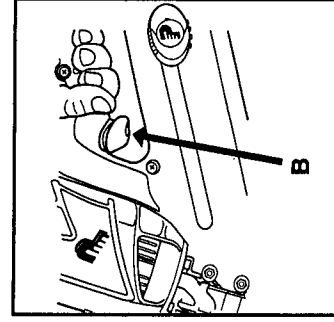

# Impulse Tool System Operation

## 8. Depth of Drive Adjustment

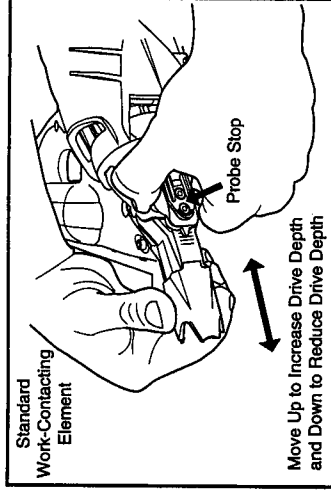

The driven depth of a fastener may be adjusted by lengthening or shortening the overall length of the work contact element. To adjust work contact element:

1. Remove fuel and battery cells.
2. Pulling the probe stop outward away from the tool will allow the work contacting element to be moved up or down. If the tool is over-driving (the nail head is driven below the surface of the wood), the work contacting element should be moved down slightly. If the nails stand up (the head is above the wood surface), the work contacting element should be moved up slightly. The indicator marks are set at 3mm increments.

## 9. Clearing a Nail Jam

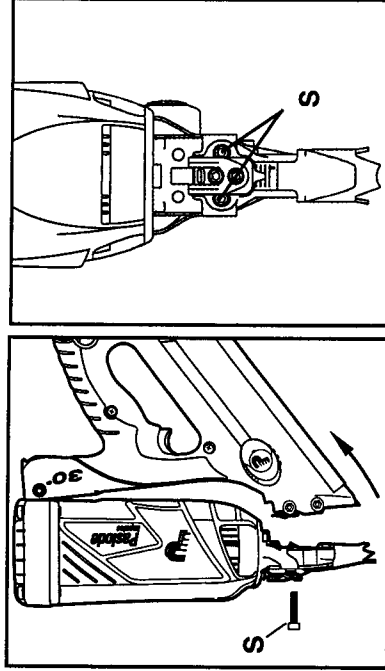

Should a fastener jam in the nose of the tool proceed as follows:

1. Remove fuel and battery cells.
2. Pull follower back to locked position and remove fasteners.
3. Undo and remove the two magazine mounting screws (S).
4. Ease the magazine away and remove jammed fastener.
5. Re-align magazine and refit mounting screws (S).
6. Reload fuel and battery cells.
7. Reload fasteners and release follower.

## 10. Adjusting the Utility Hook

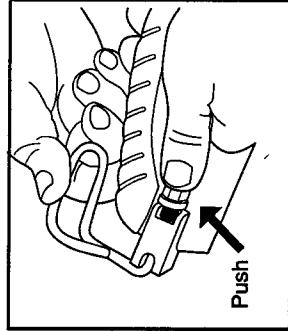

The adjustable utility hook can be used as a belt or rafter hook. To adjust the utility hook, push the black button in the direction of the arrow and rotate the hook to the desired position.

## 11. Cleaning the Air Filter

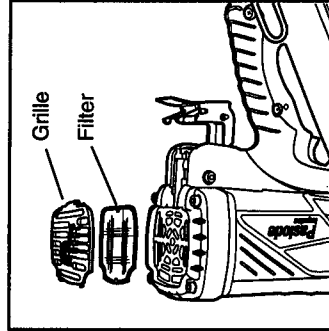

Open the grille by pressing slightly above the adapter, and pivoting the cover open. The air filter simply lifts out. Tap the filter GENTLY to remove any dust. Check and clean the air filter every two days. Soap and water restores the air filter to "like new" condition.

## 12. Cleaning your Tool

Periodic cleaning and oiling are necessary to keep the Paslode Impulse FrameMaster Nailer operating properly. See the Cleaning Procedure document that was included with your tool for complete instructions.